

# KATALOG PRODUKTÓW

EDYCJA  
MARZEC  
2024



SPRAWDŹ KATALOG  
W WERSJI ON-LINE!



[www.inter-s.pl/katalog-wirtualny](http://www.inter-s.pl/katalog-wirtualny)





**CENTRALA:**

ul. Mazowiecka 10, 96-300 Żyrardów

tel.: +48 46 854 42 47, fax: 46 855 00 76

e-mail: [biuro@inter-s.pl](mailto:biuro@inter-s.pl), [www.inter-s.pl](http://www.inter-s.pl), [www.motive.tools](http://www.motive.tools)

**Przedstawiciele handlowi**

1	Zachodniopomorskie	668 569 367 734 210 165	<a href="mailto:szczecin@inter-s.pl">szczecin@inter-s.pl</a> , <a href="mailto:koszalin@inter-s.pl">koszalin@inter-s.pl</a>
2	Wielkopolskie	501 044 589 734 210 163 538 551 049	<a href="mailto:poznan@inter-s.pl">poznan@inter-s.pl</a>
3	Lubuskie	787 148 646 538 448 029	<a href="mailto:gorzow@inter-s.pl">gorzow@inter-s.pl</a>
4	Kujawsko-Pomorskie	668 569 459 880 894 947	<a href="mailto:bydgoszcz@inter-s.pl">bydgoszcz@inter-s.pl</a>
5	Pomorskie	508 092 862 668 570 323 882 710 564	<a href="mailto:gdansk@inter-s.pl">gdansk@inter-s.pl</a>
6	Warmińsko-Mazurskie	508 092 864 509 311 627	<a href="mailto:olsztyn@inter-s.pl">olsztyn@inter-s.pl</a>
7	Podlaskie	501 044 594 882 919 878 668 568 676	<a href="mailto:bialystok@inter-s.pl">bialystok@inter-s.pl</a>
8	Lubelskie	668 568 676 532 086 568 882 919 878	<a href="mailto:lublin@inter-s.pl">lublin@inter-s.pl</a>
9	Mazowieckie	508 092 803 508 092 804 510 291 055 668 568 676	<a href="mailto:warszawa@inter-s.pl">warszawa@inter-s.pl</a>
10	Podkarpackie	668 568 650	<a href="mailto:rzeszow@inter-s.pl">rzeszow@inter-s.pl</a>
11	Świętokrzyskie	538 462 099	<a href="mailto:kielce@inter-s.pl">kielce@inter-s.pl</a>
12	Małopolskie	664 126 467 886 322 213	<a href="mailto:krakow@inter-s.pl">krakow@inter-s.pl</a>
13	Śląskie	882 351 549 886 322 213	<a href="mailto:katowice@inter-s.pl">katowice@inter-s.pl</a>
14	Łódzkie	668 572 145 668 571 917	<a href="mailto:lodz@inter-s.pl">lodz@inter-s.pl</a>
15	Dolnośląskie	539 772 134 538 448 029	<a href="mailto:wroclaw@inter-s.pl">wroclaw@inter-s.pl</a>
16	Opolskie	880 520 178	<a href="mailto:wroclaw@inter-s.pl">wroclaw@inter-s.pl</a>

**Dyrektorzy regionalni**

1, 3, 5, 15, 16

508 092 867

2, 4, 9, 14

668 568 881

6, 7, 8, 10, 11, 12, 13

509 838 429



**EXPORT:**

e-mail: [export@inter-s.pl](mailto:export@inter-s.pl)

+48 532 757 701

[piotr.materski@inter-s.pl](mailto:piotr.materski@inter-s.pl)

+48 532 721 022

[m.sieklucki@inter-s.pl](mailto:m.sieklucki@inter-s.pl)

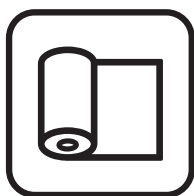

7-18

## FOLIE I ARTYKUŁY OCHRONNE

ПЛЕНКИ, СРЕДСТВА ЗАЩИТЫ, FOILS AND PROTECTIVE ARTICLES, SCHUTZARTIKEL  
UND FOLIEN, FOLII PROTECTIE, ECHIPAMENT PROTECTIE

- Plandeki i folie malarskie
- Maty malarskie i remontowe
- Tektura
- Folia i papier Speedy Mask
- Folie samoprzylepne ochronne
- Kurtyna przeciwpyłowa
- Ścierki
- Folie stretch, budowlane i paroizolacyjne
- Plandeki z oczkami
- Worki na odpady i gruz
- Worki przemysłowe
- Big bagi



19-34

## ODZIEŻ ROBOCZA I ARTYKUŁY BHP

СПЕЦОДЕЖДА И СТАТЬИ ПО БЕЗОПАСНОСТИ, WORKWEAR AND SAFETY ARTICLES,  
ARBEITSKLEIDUNG UND SICHERHEITSARTIKEL, ARTICOLE DE ÎMBRĂCĂMINTE DE LUCRU ȘI DE SIGURANȚĂ

- Kaski, nauszники
- Gogle i okulary ochronne
- Maski
- Kamizelki, kombinezony
- Szelki bezpieczeństwa i amortyzatory
- Rękawice ochronne
- Nakolanniki
- Spodnie, bluzy i koszule robocze
- Buty, chodaki, kalosze



35-50

## TAŚMY

ЛЕНТЫ, TAPES, BÄNDER, BENZI ADEZIVE

- Taśmy maskujące
- Taśmy PVC i PE
- Taśmy dwustronne
- Taśmy uniwersalne
- Taśmy tynkarskie i elewacyjne
- Taśmy remontowe
- Taśmy montażowe
- Taśmy izolacyjne i PTFE
- Taśmy aluminiowe i metalizowane
- Taśmy antypoślizgowe
- Taśmy ostrzegawcze
- Taśmy opakowaniowe



51-90

## ARTYKUŁY MALARSKIE

МАЛЯРНЫЕ ИНСТРУМЕНТЫ, PAINTING TOOLS AND ACCESSORIES  
MALERWERKZEUGE, UNELTE DE ZUGRAVIT

- Wkłady, wałki i rolki
- Uchwyty do wałków
- Artykuły Wooster
- Rolki do struktur i gładzi
- Zestawy malarskie
- Myjka do wałków i pędzli
- Kuwety i wkłady do kuwet
- Kratki malarskie
- Kije teleskopowe
- Wiadra malarskie
- Skrobaki i ostrza

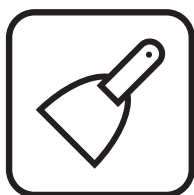

91-126

## NARZĘDZIA BUDOWLANE

СТРОИТЕЛЬНЫЕ ИНСТРУМЕНТЫ, CONSTRUCTION TOOLS,  
BAUWERKZEUGE, UNELTE CONSTRUCTII

- Rajberki
- Pace
- Zdzieraki
- Kielnie
- Szpachle powierzchniowe
- Szpachelki
- Mieszadła
- Miseczki, pojemniki, kasty, wiadra
- Poziomice, łaty
- Nożyce, przecinaki
- Młotki
- Trzonki



127-140

- Pędzle
- Tapetówki
- Ławkowce
- Chlapaki
- Smołowce
- Ulicówki

## PĘDZLE I SZCZOTKI

КИСТИ, PAINTBRUSHES

PINSEL, BESEN, PENSULE, BIDINELE, MATURI

- Wymienne kije
- Zamiatacze
- Miotły
- Zmiotki
- Wycieraczki

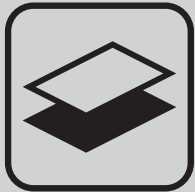

141-152

- Papiery ściernie
- Zacieraczki
- Krążki ściernie
- Ściernice

## ARTYKUŁY ŚCIERNE

АБРАЗИВЫ, ABRASIVE ARTICLES,

SCHLEIFZUBEHÖR, ABRAZIVE

- Gąbki do szlifowania
- Szczotki doczołowe
- Szczotki tarczowe
- Szczotki druciane

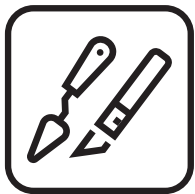

153-172

- Kliny, klipsy
- Zestaw do poziomowania płytek
- Komplet glazurniczy
- Krzyżyki dystansowe
- Fugownice, gąbki do glazury
- Pace do fugowania

## ARTYKUŁY GLAZURNICZE I NARZĘDZIA DO TAPETOWANIA

ИНСТРУМЕНТ ДЛЯ ОБЛИЦОВОЧНЫХ РАБОТ И НАКЛЕЕВАНИЯ ОБОЕВ, TILING ACCESSORIES AND WALLPAPERING TOOLS, FLIESEN- UND TAPETIERZUBEHÖR, SCULE MONTAJ PLACI CERAMICE

- Włókniny, skrobaki
- Maszynki do glazury
- Noże, noże łamane, nożyczki
- Ostrza
- Szpachelki do silikonu
- Rolki do wylewek

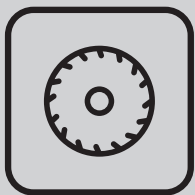

173-180

- Tarcze diamentowe
- Tarcze do cięcia metali
- Tarcze do cięcia betonu, ceramiki
- Zestawy wiertel
- Wiertła do metalu

## TARCZE I WIERTŁA

ДИСКИ И СВЕРЛ, DISCS, DRILLS,

TRENNSCHEIBEN UND BOHRER, DISCURI, BURGHIE

- Wiertła SDS do betonu
- Otwornice do betonu, ceramiki
- Frez do styropianu
- Otwornice w komplecie



181-202

- Piły ręczne, brzeszczoty
- Skrzynki uciosowe
- Skrzynki i kuwety narzędziowe
- Zestawy bitów
- Podpory teleskopowe
- Ołówki, markery, sznury i kredy traserskie

## ARTYKUŁY RÓŻNE

РАЗНОЕ, OTHER PRODUCTS,

SONTIGES, ACCESSORII

- Miary, sznurki, żyłki
- Wyciskacze do mas i silikonów
- Pistolety do pianki
- Zszywacze, opaski
- Pasy transportowe
- Lampy LED



## NARZĘDZIA I AKCESORIA STOLARSKIE

СТОЛЯРНЫЙ ИНСТРУМЕНТ И АКЦЕССУАРЫ, CARPENTRY TOOLS AND ACCESSORIES,  
TISCHLERWERKZEUG, UNELTE PENTRU PRELUCRAT LEMN

203-208

- Ściski pełnopowierzchniowe
- Listwy prowadzące
- Ściski sprężynowe
- Ściski śrubowe
- Kątowniki zaciskowe
- Kątowniki stolarskie



## NARZĘDZIA BIHUI

ИНСТРУМЕНТЫ, TOOLS,  
WERKZEUGE, UNELTE

209-230

- Narzędzia budowlane
- Artykuły glazurnicze
- Tarcze
- Otwornice
- Elektronarzędzia
- Stoły robocze
- Akcesoria



## DRABINY

ЛЕСТНИЦЫ, LADDERS,  
LEITERN, SCĂRI

231-256

- Drabiny wolnostojące jedno i dwustronne
- Drabiny teleskopowe
- Drabiny wielofunkcyjne
- Podesty i platformy robocze
- Minirusztowania
- Koziołki drewniane
- Drabiny drewniane, malarskie
- Drabiny wieloelementowe
- Drabiny przegubowe



## ARTYKUŁY OGRODNICZE

ИНСТРУМЕНТЫ ДЛЯ САДА И ОГОРОДА, GARDENING EQUIPMENT,  
GARTENWERKZEUGE, UNELTE PENTRU GRADINA

257-281

- Wężę ogrodowe
- Złączki, przyłącza, łączniki
- Trójniki, rozdzielacze
- Pistolety do zraszania, zraszacze
- Ręczne narzędzia ogrodowe
- Nożyce, sekatory
- Widły, łopaty, grabie
- Trzonki
- Siekiery
- Zestawy

**SZUKASZ OKAZJI,  
CHCESZ ZAOSZCZĘDZIĆ?**

ODWIEDŹ  
**NASZ % OUTLET**

[www.inter-s.pl/outlet](http://www.inter-s.pl/outlet)





# FOLIE I ARTYKUŁY OCHRONNE

ПЛЕНКИ, СРЕДСТВА ЗАЩИТЫ • FOILS AND PROTECTIVE ARTICLES

• SCHUTZARTIKEL UND FOLIEN • FOLII PROTECTIE, ECHIPAMENT PROTECTIE



# CHRONI I ZABEZPIECZA



## MATTI DO ZADAŃ SPECJALNYCH

**NOWOŚĆ**

**210 g/m<sup>2</sup>**

Nr kat. 010 266

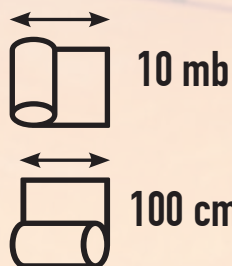

### Wprowadziliśmy go do oferty!

- ✓ Przedstawia się jako Matti Cover
- ✓ Jest solidny i konkretny
- ✓ Nie boi się płynnych substancji (farb czy olejów)
- ✓ Przyjmuje na siebie uderzenia i upadki z małej wysokości
- ✓ Potrafi tłumić drgania
- ✓ Śmiało dźwiga na sobie ciężary i nie narzeka
- ✓ Jest odporny na rozdarcia, bo jest wielowarstwowy
- ✓ Chroni innych przed zarysowaniem i uszkodzeniem
- ✓ Często przebywa na budowach, ale też jest domownikiem
- ✓ Jego hobby to remonty i majsterkowanie
- ✓ Ma aż 10 metrów długości i 1 m szerokości
- ✓ Nosi się na pomarańczowo







**PLANDEKA MALARSKA GAT. I**

Plastic drop sheet, I quality • Плёнка малярная сорт 1 • Abdeckfolie  
 • Folie protectie

NUMER KATALOGOWY				
010 206	60 µm	4 m	5 m	10/480



**PLANDEKA MALARSKA GAT. I**

Plastic drop sheet, I quality • Плёнка малярная сорт 1 • Abdeckfolie  
 • Folie protectie

NUMER KATALOGOWY				
010 515	42 µm	4 m	5 m	20



**PLANDEKA MALARSKA GAT. I**

Plastic drop sheet, I quality • Плёнка малярная сорт 1 • Abdeckfolie  
 • Folie protectie

NUMER KATALOGOWY				
010 205	30 µm	4 m	5 m	15/720



**FOLIA MALARSKA OPAL**

Plastic drop sheet LDPE • Плёнка малярная • Malerplane  
 • Folie protectie

NUMER KATALOGOWY				
010 513	60 µm	4 m	5 m	10



**FOLIA MALARSKA OPAL**

Plastic drop sheet LDPE • Плёнка малярная • Malerplane  
 • Folie protectie

NUMER KATALOGOWY				
010 512	45 µm	4 m	5 m	12





**FOLIA MALARSKA OPAL**  
Plastic drop sheet LDPE • Плёнка малярная • Malerplane  
• Folie protectie

NUMER  
KATALOGOWY



010 511

30 µm

4 m

5 m

20



**PLANDEKA MALARSKA 4/5 CZERWONA**  
Plastic drop sheet LDPE • Плёнка малярная • Malerplane  
• Folie protectie

NUMER  
KATALOGOWY



010 204

60 µm

4 m

5 m

10/480



**PLANDEKA MALARSKA 4/5 NIEBIESKA**  
Plastic drop sheet LDPE • Плёнка малярная • Malerplane  
• Folie protectie

NUMER  
KATALOGOWY



010 203

40 µm

4 m

5 m

20/800



**PLANDEKA MALARSKA 4/5 ŻÓŁTA**  
Plastic drop sheet LDPE • Плёнка малярная • Malerplane  
• Folie protectie

NUMER  
KATALOGOWY



010 202

30 µm

4 m

5 m

20/960



**PLANDEKA MALARSKA 4/5 ZIELONA**  
Plastic drop sheet LDPE • Плёнка малярная • Malerplane  
• Folie protectie

NUMER  
KATALOGOWY



010 201

20 µm

4 m

5 m

25/1200



### FOLIA MALARSKA

Plastic drop sheet HDPE • Плёнка малярная • Abdeckfolie • Folie protectie

NUMER KATALOGOWY				
010 208	7 µm	4 m	5 m	50/2400
010 243	7 µm	4 m	12,5 m	1/25



### FOLIA MALARSKA

Plastic drop sheet HDPE • Плёнка малярная • Abdeckfolie • Folie protectie

NUMER KATALOGOWY				
010 210	5 µm	4 m	5 m	40



### FOLIA OCHRONNA

Polythene dust sheet roll • Пленка защитная • Abdeckfolie • Folie protectie

NUMER KATALOGOWY				
010 209	35 µm	3 m	20 m	1



### MATA MALARSKA

Dust sheet fleece • Защитная пленка с фетром • Malerabdeckvlies  
 • Pâslă de acoperire

NUMER KATALOGOWY				
010 116	220 g/m²	1 m	10 m	1/6

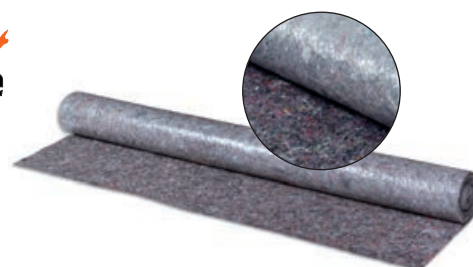

### MATA MALARSKA

Dust sheet fleece • Защитная пленка с фетром • Malerabdeckvlies  
 • Pâslă de acoperire

NUMER KATALOGOWY				
010 115	180 g/m²	1 m	10 m	1/6/120

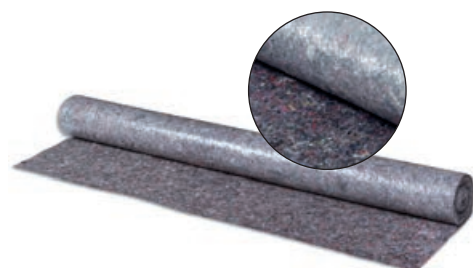

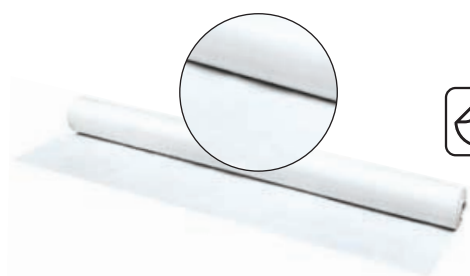

**motive**  
Jakość ma znaczenie



**MATA MALARSKA STICKY**

Dust sheet fleece sticky • Защитная пленка с фетром sticky  
• Abdeckvlies selbstklebend • Pâslă de acoperire

NUMER  
KATALOGOWY



010 117

100 cm

10 m

1/6

010 118

50 cm

10 m

1/6



**motive**  
Jakość ma znaczenie



**MATA BUDOWLANA MATTI COVER**

Heavy duty protection pad • Пленка строительная с войлоком  
• Bodenschutzmatte • Pâslă de acoperire

NUMER  
KATALOGOWY



010 266

1 m

10 m

1



**motive**  
Jakość ma znaczenie



**MATA BUDOWLANA PROTEKTOR**

Heavy duty protection pad • Пленка строительная с войлоком Protaktor  
• Bodenschutzmatte • Pâslă de acoperire Protaktor

NUMER  
KATALOGOWY



010 264

1 m

10 m

1

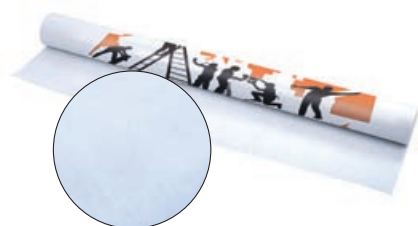

**motive**  
Jakość ma znaczenie



**MATA REMONTOWA COVER-TEX**

Non-woven Cover-Tex • Пленка ремонтная с нетканым материалом  
• Bodenschutzmatte • Pâslă de acoperire Cover-Tex

NUMER  
KATALOGOWY



010 265

1 m

10 m

1



**TEKTURA FALISTA**

Corrugated cardboard roll • Картон волнистый • Rollenwellpappe  
• Carton ondulat de protectie

NUMER  
KATALOGOWY

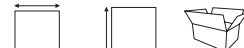

010 113

1 m

15 m

1/36



**TEKTURA BUDOWLANA IZOLACYJNA**

Building paper roll • Картон строительный изоляционный • Abdeckpappe  
• Carton de protecție

NUMER  
KATALOGOWY

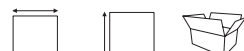

010 114

1 m

15 m

1/80



### FOLIA SPEEDY MASK

Pre taped masking film - Плёнка защитная SPEEDY MASK с липким слоем  
 • Abdeckfolie mit Selbstklebeband • Banda de mascare cu folie de protectie

NUMER KATALOGOWY								
010 170	STANDARD		16 mm	9 µm	1100 mm	33 m	1/25	
010 171	STANDARD		16 mm	9 µm	2700 mm	20 m	1/25	
010 172	STANDARD		16 mm	9 µm	550 mm	33 m	1/50	
010 173	STANDARD		16 mm	9 µm	1400 mm	20 m	1/50	
010 174	STANDARD		16 mm	9 µm	300 mm	33 m	1/25	
010 175	STANDARD		16 mm	9 µm	1800 mm	20 m	1/25	
010 232	COMFORT		25 mm	9 µm	1100 mm	33 m	1/25	
010 233	COMFORT		25 mm	9 µm	2700 mm	20 m	1/25	
010 234	COMFORT		25 mm	9 µm	300 mm	33 m	1/50	
010 235	COMFORT		25 mm	9 µm	550 mm	33 m	1/50	
010 236	COMFORT		25 mm	9 µm	1400 mm	20 m	1/25	
010 237	COMFORT		25 mm	9 µm	1800 mm	20 m	1/25	
010 181	PROMASK		25 mm	9 µm	1100 mm	33 m	1/25	
010 182	PROMASK		25 mm	9 µm	2200 mm	20 m	1/25	
010 183	PROMASK		25 mm	9 µm	550 mm	20 m	1/25	
010 184	PROMASK		25 mm	9 µm	1500 mm	20 m	1/25	
010 180	COMFORT		30 mm	9 µm	3000 mm	20 m	1/25	

**motive**   
 Jakość ma znaczenie

HDPE



### PAPIER SPEEDY MASK

Pre-taped masking paper • Защитная бумага speedy mask • Abdeckpapier mit Klebeband • Hartie mascare cu banda adeziva

NUMER KATALOGOWY				
010 275	25 mm	300 mm	20 m	1/6
010 276	25 mm	450 mm	20 m	1/6

**motive**   
 Jakość ma znaczenie



### DYSPENSER Z FOLIĄ SPEEDY MASK

Pre taped masking film with dispenser • Пленка защитная с клейкой лентой • Abdeckfolie mit Klebeband plus Abroller • Banda de mascare cu folie de protectie + dispenser

NUMER KATALOGOWY					
010 281	25 mm	9 mm	550 mm	20 m	1/6
010 282	25 mm	9 mm	2700 mm	20 m	1/6

**motive**   
 Jakość ma znaczenie

HDPE



### FOLIA SAMOPRZYLEPNA NIEBIESKA

Window protection film blue • Самоклеящаяся защитная пленка • Selbstklebende Schutzfolie - blau • Folie de protectie autoadezivă

NUMER KATALOGOWY				
010 214	60 µm	25 cm	30 m	1/12/360
010 216	60 µm	50 cm	30 m	1/6/180
010 217	60 µm	50 cm	75 m	1/6/168

**motive**   
 Jakość ma znaczenie



### FOLIA SAMOPRZYLEPNA NIEBIESKA

Window protection film blue • Самоклеящаяся защитная пленка • Selbstklebende Schutzfolie - blau • Folie de protectie autoadezivă

NUMER KATALOGOWY				
010 285	40 µm	50 cm	75 m	1/6





**motive**  
Jakość ma znaczenie

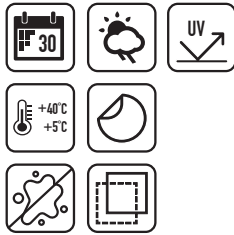

#### FOLIA SAMOPRZYLEPNA PRZEZROCZYSTA

Window protection film transparent • Пленка самоклеящаяся бесцветная  
• Selbstklebende Schutzfolie- transparent • Folie de protectie autoadezivă

NUMER KATALOGOWY				
010 262	60 µm	50 cm	30 m	1/6/180
010 263	60 µm	50 cm	75 m	1/6/180



**motive**  
Jakość ma znaczenie



#### KURTYNA PRZECIWPYŁOWA

Dust stop zip door • Пылезащитная шторка • Folie Staubschutztür mit Reißverschluss • Folie uşă anti-praf

NUMER KATALOGOWY			
010 238	120 cm	220 cm	1/6



#### ŚCIERKA DO PODŁOGI 5 szt.

Floor cleaning cloth (5 pcs) • Тряпка половая (5шт.) • Bodentuch (5 Stück)  
• Cărpă pentru şters podeaua (5 buc)

NUMER KATALOGOWY				
010 380	biała/white	60 cm	70 cm	5/20
010 381	szara/grey	60 cm	70 cm	5/20



#### ŚCIERKA TETRA 25 szt.

Cotton cleaning cloth (20 pcs) • Тряпка тетровая (20 шт.)  
• Mullwaschlappen (20 Stück) • Cărpă tetra (20 buc)

NUMER KATALOGOWY			
010 382	80 cm	60 cm	1/30



#### MINIRAP KOMPLET

Stretch wrap mini roll dispenser • Мини-рап комплект • Mini-Stretchfolie mit Dispenser • Folie stretch manuala tip mini roll

NUMER KATALOGOWY		
010 231	10 cm	1/27



#### MINIRAP ZAPAS 2 szt.

Mini stretch wrap, 2 pcs. • Мини-рап, ролики (2 шт.) • Mini-Stretch folie 2 Stücke • Folie stretch manuala tip mini roll

NUMER KATALOGOWY		
010 230	10 cm	1/20



**FOLIA STRETCH 23 µm**

Stretch wrap film, clear • Плёнка STRETCH • Handstreichfolie- transparent  
 • Folie extensibila



NUMER KATALOGOWY			
010 220	50 cm	1,2 kg netto	6/300
010 218	50 cm	2,5 kg netto	6



**FOLIA STRETCH CZARNA 23 µm**

Stretch wrap film, black • Плёнка STRETCH черная • Handstreichfolie- schwarz  
 • Folie extensibila neagra



NUMER KATALOGOWY			
010 219	50 cm	1,2 kg netto	6/300
010 212	50 cm	2,5 kg netto	6



**FOLIA CZARNA PE**

Black foil PE • Плёнка защитная чёрная • LDPE-Folie, schwarz  
 • Folie PE neagra



NUMER KATALOGOWY			
010 108	4 m	5 m	1/5



**FOLIA BUDOWLANA ATEST**

Damp proof membrane, certified • Плёнка защитная чёрная (сертификация) • Baufolie mit Zertifikat • Folie PE neagra



NUMER KATALOGOWY				
010 103	0,2 mm	5 m	20 m	1



**FOLIA CZARNA PE**

Damp proof membrane • Плёнка защитная чёрная PE • Baufolie • Folie PE neagra



NUMER KATALOGOWY				
010 109	TYP 150	5 m	20 m	1/50
010 110	TYP 150	4 m	25 m	1/50
010 111	TYP 200	4 m	25 m	1/50
010 112	TYP 200	5 m	20 m	1/50
010 106	TYP 300	5 m	20 m	1/90





### FOLIA PAROIZOLACYJNA - ATEST

Vapour barrier membrane, certified • Плёнка пароизоляционная (сертификация) • Dampfsperffolie mit Zertifikat • Folie PE galben

NUMER  
KATALOGOWY



010 104

0,2 mm

2 m

50 m

1



### FOLIA ŻÓŁTA PE

Vapour barrier membrane • Плёнка жёлтая PE • Garo izolaciinė plėvelė, geltona • Dampfsperffolie • Folie PE galden

NUMER  
KATALOGOWY



010 101

TYP 200

2 m

50 m

1/50



### PLANDEKA Z OCZKAMI

Tarpaulin • Тент защитный • Gewebeplane • Prelata impermeabila

NUMER  
KATALOGOWY



010 126

150 g/m<sup>2</sup>

2 m

3 m

1/20

010 127

150 g/m<sup>2</sup>

3 m

4 m

1/10

010 128

150 g/m<sup>2</sup>

3 m

5 m

1/8

010 129

150 g/m<sup>2</sup>

4 m

6 m

1/5

010 130

150 g/m<sup>2</sup>

5 m

8 m

1/3

010 131

150 g/m<sup>2</sup>

6 m

10 m

1/2

010 132

150 g/m<sup>2</sup>

10 m

15 m

1



### PLANDEKA Z OCZKAMI (50 g +/- 5%)

Tarpaulin • Тент защитный • Gewebeplane • Prelata impermeabila

NUMER  
KATALOGOWY



010 119

50 g/m<sup>2</sup>

3 m

4 m

1/45

010 120

50 g/m<sup>2</sup>

2 m

3 m

1/50

010 121

50 g/m<sup>2</sup>

3 m

5 m

1/40

010 122

50 g/m<sup>2</sup>

4 m

6 m

1/15

010 123

50 g/m<sup>2</sup>

5 m

8 m

1/10

010 124

50 g/m<sup>2</sup>

6 m

10 m

1/2

010 125

50 g/m<sup>2</sup>

10 m

15 m

1/2

010 140

50 g/m<sup>2</sup>

4 m

5 m

1/20

010 141

50 g/m<sup>2</sup>

4 m

8 m

1/15

010 142

50 g/m<sup>2</sup>

5 m

6 m

1/10

010 143

50 g/m<sup>2</sup>

6 m

8 m

1/8

010 144

50 g/m<sup>2</sup>

8 m

10 m

1/2

010 145

50 g/m<sup>2</sup>

8 m

12 m

1/2

010 146

50 g/m<sup>2</sup>

10 m

12 m

1/2



010 224  
010 240



### WORKI NA ŚMIECI

Rubbish bags • Мешки для мусора • Müllsäcke • Saci menajeri

NUMER  
KATALOGOWY



010 221

50x60 cm

35 L

25

1/32

010 222

60x80 cm

60 L

25

1/30

010 223

70x110 cm

120 L

25

1/8

010 224

80x135 cm

160 L

10

1/10

010 240

120x140 cm

240 L

10

1/10





**WORKI NA ODPADY SEGREGOWANE**

Bags for waste segregation • Мешки для мусора • Beutel für Mülltrennung • Saci pentru colectarea selectivă

NUMER KATALOGOWY						
010 253	bio odpady/bio-waste		70x110 cm	120 L	25	1/10
010 254	szkło/glass		70x110 cm	120 L	25	1/10
010 255	plastik/plastic		70x110 cm	120 L	25	1/16
010 256	papier/paper		70x110 cm	120 L	25	1/16

**WORKI DO ODPADÓW LEKKICH 1200x2400 5 szt.**

Rubbish bags • Мешки для легкого мусора • Müllsäcke • Saci Polietilena

NUMER KATALOGOWY				
010 245	120x240 cm	500 L	5	1/15

**WORKI NA GRUZ 10 szt.**

Rubble bags (10 pcs) • Мешки для строительного мусора (10 шт.) • Schwergutsäcke (10 Stück) • Saci pentru moloz (10 bucati)

NUMER KATALOGOWY				
010 258	60x100cm	70 L	10	1/10
010 242	70x110 cm	120 L	10	1/10

**WORKI PRZEMYSŁOWE CZARNE 10 szt.**

Rubble sacks (10 pcs) • Промышленные мешки (10 шт.) • Schwergutsäcke (10 Stück) • Saci pentru moloz (10 bucati)

NUMER KATALOGOWY			
010 150	60x100 cm	70 L	1/18
010 151	70x110cm	120 L	1/18
010 152	80x135 cm	160 L	1/12
010 153	120x140 cm	240 L	1/10
010 154	125x160 cm	320 L	1/6

**WORKI PRZEMYSŁOWE NIEBIESKIE 10 szt.**

Rubble sacks (10 pcs) • Промышленные мешки (10 шт.) • Schwergutsäcke (10 Stück) • Saci pentru moloz (10 bucati)

010 160	70x110 cm	120 L	1/20
010 161	120x140 cm	240 L	1/10

**WORKI POLIPROPYLENOWE**

PP (polipropylene woven) bags • Мешки полипропиленовые • PP- Gewebesack • Saci de rafie

NUMER KATALOGOWY				
010 228	25 kg	500 mm	880 mm	1/100/1000
010 229	50 kg	650 mm	1050 mm	1/100/1000

**motive**  
Jakość ma znaczenie



**motive**  
Jakość ma znaczenie



010 242  
010 258



**motive**  
Jakość ma znaczenie



010 150  
010 151  
010 152  
010 153  
010 154



**motive**  
Jakość ma znaczenie



010 161





**BIG BAG**

Big bag • Мешок Big bag • BIG BAG • Saci de rafie Big Bag

NUMER  
KATALOGOWY

010 251



1000 kg



90 x 90 x 100 cm



1

# ODZIEŻ ROBOCZA I ARTYKUŁY BHP

WORKWEAR AND SAFETY ARTICLES • СПЕЦОДЕЖДА И СТАТЬИ ПО БЕЗОПАСНОСТИ  
• ARBEITSKLEIDUNG UND SICHERHEITSARTIKEL • ARTICOLE DE ÎMBRĂCĂMINTE DE LUCRU ȘI DE SIGURANȚĂ





#### KASK OCHRONNY

Protective helmet • Защитный шлем • Schutzhelm • Casca de protectie

NUMER KATALOGOWY			
010 335		53-61 cm	1/50
010 337		53-61 cm	1/50
010 336		53-61 cm	1/50



#### KASK OCHRONNY EVO2

Protective helmet EVO2 • Защитный шлем EVO2 • Schutzhelm EVO2  
• Casca de protectie EVO2

NUMER KATALOGOWY			
010 361	niebieski/blue	53-64 cm	1/10



#### ZATYCZKI 200x2 szt.

Ear plugs • Тапи за уши • Ohrstöpsel • Dopuri urechi

NUMER KATALOGOWY	
010 500	1/10



#### NAUSZNIKI OCHRONNE

Earmuffs • Наушники против шумные • Kapselgehörschutz  
• Casti antifon cu banda de prindere pe cap

NUMER KATALOGOWY	
010 357	1/50



#### GOGLE GOSPODARCZE

Protective goggles • Защитные очки • Apsauginiai akiniai • Schutzbrille  
• Ochelari de protectie universala cu aerisire indirecta

NUMER KATALOGOWY	
010 355	1/200



**OKULARY OCHRONNE LAW-S**

Protective spectacles LAW-S • Защитные очки LAW-S • Schutzbrille LAW-S  
 • Ochelari de protectie LAW-S

NUMER  
KATALOGOWY



010 352

1/10/120



**OKULARY OCHRONNE LAW-T**

Protective spectacles LAW-T • Защитные очки LAW-T • Schutzbrille LAW-T  
 • Ochelari de protectie LAW-T

NUMER  
KATALOGOWY



010 353

1/10



**OKULARY OCHRONNE KALAHARI**

Protective spectacles KALAHARI • Защитные очки KALAHARI  
 • Schutzbrille KALAHARI • Ochelari de protectie KALAHARI

NUMER  
KATALOGOWY



010 378

1



**OKULARY OCHRONNE**

Safety spectacles • Защитные очки • Besucherbrille  
 • Ochelari de protectie universala

NUMER  
KATALOGOWY



010 354

1/10/200



**OKULARY OCHRONNE REGULOWANE**

Adjustable safety spectacles • Защитные очки, регулируемые  
 • Schutzbrille, verstellbar • Ochelari de protectie universala  
 cu lentile incolore si brate ajustabile

NUMER  
KATALOGOWY



010 342

1/10/200



**OKULARY OCHRONNE**

Tsavo- Schutzbrille • Защитные очки • Besucherbrille • Ochelari de protectie  
 universala

NUMER  
KATALOGOWY



TSAVO

1/10

TSAVO SUN

przyciemniane/tinted

1/10





**SAFETY  
JOGGER**  
INDUSTRIAL



#### OKULARY OCHRONNE

Schutzbrille • Защитные очки • Besucherbrille  
• Ochelari de protectie universala

NUMER  
KATALOGOWY



VIRUNGA

1/10



#### PRZYŁBICA OCHRONNA

Protective visor • Защитный козырек для лица • Gesichtsschutz schutzvisier  
• Vizieră de protecție

NUMER  
KATALOGOWY



010 362

1/60



**motive**  
Jakość ma znaczenie



#### MASKI PRZECIWPYŁOWE

Dust masks • Респиратор • Staubschutzmaske • Masca protectie praf

NUMER  
KATALOGOWY



010 350

FFP1 (10)

10/20/400

010 440

FFP1 (3)

3/21/420



**motive**  
Jakość ma znaczenie



#### PÓLMASKI PRZECIWPYŁOWE Z ZAWORKIEM

Dust mask with valve • Респиратор с клапаном • Staubschutzmaske mit Ventil • Masca protectie praf

NUMER  
KATALOGOWY



010 351

FFP1 (10)

10/400

010 441

FFP1 (3)

3/21/420

010 349

FFP2 (10)

10/400

010 442

FFP2 (3)

3/21/420



POLYESTER



#### KAMIZELKA ODBLASKOWA

Hi-viz vest • Светоотражающая жилетка • Reflexion Weste  
• Vesta de semnalizare galbena

NUMER  
KATALOGOWY



010 330



XXL

1/100

010 331



XXL

1/100

010 430



XXXL

1/100

010 431





XXXXL

1/100



### KURTKA PRZECIWDDESZCZOWA

Rain jacket • Куртка-дождевик • Regenjacke • Jacheta ploaie din PVC



NUMER KATALOGOWY		
010 259	L	1/20
010 270	XL	1/20
010 271	XXL	1/20

PVC + POLYESTER



### PŁASZCZ PRZECIWDDESZCZOWY

Raincoat • Плащ дождевик • Regenmantel • Pelerina ploaie din PVC galben

NUMER KATALOGOWY		
010 358	L	1/20
010 359	XL	1/20
010 360	XXL	1/10

PVC + POLYESTER



### KOMBINEZON MALARSKI

Polypropylene Coverall • Комбинезон малярный • Schutzanzug, Polypropylen • Combinezon de protectie de unica folosinta din polipropilena

NUMER KATALOGOWY		
010 356	XXL	1/50
010 368	XXXL	1/50



### SZELKI BEZPIECZEŃSTWA

Safety harness • Страховочная система • Auffanggurt • Centura siguranta

NUMER KATALOGOWY	
010 400	1/20



### AMORTYZATOR DO SZELEK

Shock absorbing lanyard • Амортизатор для страховочной системы • Bandfalldämpfer • Banda de sustinere, cu amortizor

NUMER KATALOGOWY	
010 401	1/20





**motive**   
Jakość ma znaczenie



#### REKAWICE GRIPP STAR (100/90 szt.)

Nitrile gloves Gripp Star (100/90 pcs) • Нитриловые перчатки Gripp Star (100/90 шт.) • Nitrilhandschuhe Gripp Star (100/90 Stück) • Manusi de protectie Gripp Star (100/90 bucati)

NUMER KATALOGOWY			
010 541	100 szt.	M	1
010 542	100 szt.	L	1
010 543	90 szt.	XL	1
010 544	90 szt.	XXL	1



**motive**   
Jakość ma znaczenie



#### REKAWICE NITRYLOWE

Nitrile gloves • Нитриловые перчатки • Nitrilhandschuhe • Manusi nitril

NUMER KATALOGOWY			
010 493		S	1/10
010 491		M	1/10
010 492		L	1/10
010 490		XL	1/10



#### REKAWICE NITRYLOWE DIAMOND (50 szt.)

Nitrile gloves (50 pcs) • Нитриловые перчатки (50 шт.) • Nitrilhandschuhe (50 Stück) • Manusi de protectie (50 bucati)

NUMER KATALOGOWY			
010 332		S	1/10
010 327		M	1/10
010 328		L	1/10
010 329		XL	1/10
010 326		XXL	1/10



#### REKAWICE NITRYLOWE DIAMOND BLACK (50 szt.)

Nitrile gloves BLACK (50 pcs) • Нитриловые перчатки BLACK (50 шт.) • Nitrilhandschuhe BLACK (50 Stück) • Manusi de protectie, neagra (50 bucati)

NUMER KATALOGOWY			
010 505		S	1/10
010 506		M	1/10
010 507		L	1/10
010 508		XL	1/10
010 509		XXL	1/10



#### REKAWICE NITRYLOWE BLUE

Nitrile gloves • Нитриловые перчатки • Nitrilhandschuhe • Manusi nitril



NUMER KATALOGOWY			
010 496		S	1/10
010 497		M	1/10
010 498		L	1/10





**RĘKAWICE LATEKS (100 szt.)**

Latex gloves (100 pcs) • Перчатки из латекса (100 шт.) • Voll-Latex-Einmal-Handschuhe (100 Stück) • Manusi universale din latex (100 bucati)



NUMER KATALOGOWY		
010 316	XL	1/10
010 317	S	1/10
010 318	M	1/10
010 319	L	1/10

LATEX



**RĘKAWICE LATEKS THICK (100 szt.)**

Latex gloves (100 pcs) • Перчатки из латекса (100 шт.) • Voll-Latex-Einmal-Handschuhe (100 Stück) • Manusi universale din latex (100 bucati)

NUMER KATALOGOWY		
010 296	M	1/10
010 297	L	1/10
010 298	XL	1/10

LATEX



**RĘKAWICE FOLIOWE**

Plastic disposable gloves • Фольгированные перчатки  
 • Plastik Einweghandschuhe • Manusi folie



NUMER KATALOGOWY		
010 495	L	1/100

HDPE



**RĘKAWICE GOSPODARCZE**

Household latex gloves • Перчатки хозяйственные резиновые  
 • Voll-Latex-Handschuhe • Manusi pentrua menaj din latex

NUMER KATALOGOWY		
010 310	S	12/240
010 323	M	12/240
010 324	L	12/240
010 325	XL	12/240

LATEX



**RĘKAWICE SUPER TECH BLUE FIX**

Working gloves SUPER TECH BLUE FIX • Перчатки SUPER TECH BLUE FIX  
 • Handschuhe SUPER TECH BLUE FIX • Manusi de protectie SUPER TECH BLUE FIX

NUMER KATALOGOWY		
010 300	10	12

POLYESTER

LATEX





BAWEŁNA  
COTTON

LATEX

**RĘKAWICE BAWĘLIANE POWLEKANE LATEKSEM**

Cotton gloves latex coated • Перчатки ВАМПИР • Arbeitshandschuhe  
Baumwolle PVC Bezug • Manusi de protectie, din tricot + latex

NUMER  
KATALOGOWY



010 301

10

10/600



BAWEŁNA  
COTTON

LATEX

**RĘKAWICE POWLEKANE LATEKSEM**

Cotton gloves latex coated • Перчатки пропитанные латексом  
• Latex-Strickhandschuhe • Manusi de protectie, imersat in latex

NUMER  
KATALOGOWY



010 347

9

12/240

010 307

10

12/240

010 348

11

12/240



POLYESTER

NITRILE

**RĘKAWICE POWLEKANE NITRYLEM**

Nitrile covered working gloves • Перчатки пропитанные нитрилом  
• Nitrilhandschuhe • Manusi de protectie, impregnate cu nitril

NUMER  
KATALOGOWY



010 304

9

12/240

010 334

10

12/240

010 333

11

12/240



NYLON

POLYURETHANE

**RĘKAWICE POLIURETANOWE**

Polyurethane covered working gloves • Перчатки полиуретановые  
• Nylon-PU-Handschuhe • Manusi de protectie, imersate in poliuretan, albe

NUMER  
KATALOGOWY



010 340

9

12/240

010 312

10

12/120

010 341

11

12/240



LATEX

**RĘKAWICE DRAGOTEX**

Latex coated working gloves DRAGOTEX • Перчатки DRAGOTEX  
• Latex Strickhandschuhe Dragotex • Manusi de protectie Dragotex

NUMER  
KATALOGOWY



010 308

9

12/240

010 338

10

12/240

010 339

11

12/240



**RĘKAWICE GRIPEX**

Latex coated working gloves GRIPEX • Перчатки GRIPEX  
 • Latex Strickhandschuhe GRIPEX • Manusi de protectie Gripex

NUMER KATALOGOWY		
010 379	10	12/240



POLYESTER

LATEX



**RĘKAWICE PES ORANGE Z NITRYLEM**

PES orange nitrile covered gloves • Перчатки пропитанные нитрилом  
 • Arbeitshandschuhe Nitril PES orange • Manusi de protectie PES Orange

NUMER KATALOGOWY		
010 470	9	12/240
010 471	10	12/240
010 472	11	12/240



POLYESTER

NITRILE



**RĘKAWICE PES Z NITRYLEM**

PES nitrile covered gloves • Перчатки пропитанные нитрилом  
 • Arbeitshandschuhe Nitril PES • Manusi de protectie PES

NUMER KATALOGOWY		
010 473	9	12/240
010 474	10	12/120
010 475	11	12/240



POLYESTER

NITRILE



**RĘKAWICE NYLON GREY Z NITRYLEM**

Nitrile covered working gloves • Перчатки пропитанные нитрилом  
 • Nitrilhandschuhe • Manusi de protectie, impregnate cu nitril

NUMER KATALOGOWY		
010 476	9	12/240
010 477	10	12/240
010 478	11	12/240



NYLON

NITRILE



**RĘKAWICE WHITE Z NITRYLEM**

Nitrile covered working gloves • Перчатки пропитанные нитрилом  
 • Nitrilhandschuhe • Manusi de protectie, impregnate cu nitril

NUMER KATALOGOWY		
010 479	9	12/240
010 480	10	12/240
010 481	11	12/240

NYLON

NITRILE





BAWEŁNA  
COTTON

LATEX

#### RĘKAWICE OILMAX

PVC coated gloves • Перчатки масло-бензостойкие • PVC Handschuhe  
• Manusi de protectie, din bumbac + pvc

NUMER  
KATALOGOWY



010 306

10

12/120



GUMA  
RUBBER

#### RĘKAWICE GRIP

Rubber coated working gloves • Перчатки прорезиненные "Grip"  
• Latex-Handschuhe mit Baumwollfutter • Manusi de protectie Grip

NUMER  
KATALOGOWY



010 305

10

12/120



**motive**  
Jakość ma znaczenie

GUMA  
RUBBER

#### RĘKAWICE EXTRA GRIP

Insulated working gloves EXTRA GRIP • Перчатки EXTRA GRIP  
• Handschuhe EXTRA GRIP • Manusi de protectie Extra Grip

NUMER  
KATALOGOWY



010 311

10

12/120



**motive**  
Jakość ma znaczenie



#### RĘKAWICE ARMOR

Working gloves ARMOR with anticut fibres • Перчатки ARMOR  
• Handschuhe ARMOR • Manusi de protectie Armor

NUMER  
KATALOGOWY



010 372

10

1/12/120



**motive**  
Jakość ma znaczenie

POLYESTER

NITRILE

#### RĘKAWICE MECHANIC

Heavy duty nitrile coated working gloves • Перчатки MECHANIC  
• Montagehandschuhe- Nitril + Polyester  
• Manusi de protectie, impregnate cu nitril

NUMER  
KATALOGOWY



010 371

10

1/12/120

010 370

11

1/12/120



POLYESTER

NITRILE

#### RĘKAWICE ORANGE

Nitrile covered working gloves • Перчатки пропитанные нитрилом  
• Nitrilhandschuhe • Manusi de protectie, impregnate cu nitril

NUMER  
KATALOGOWY



010 288

9

12/120

010 289

10

12/120



### REKAWICE TRUCKER

Cow grain leather working gloves • Перчатки TRUCKER • Nappaleder-Handschuhe TRUCKER • Manusi de protectie, din piele fina de bovina

NUMER KATALOGOWY		
010 374	9	1/12/120
010 375	10	1/12/120

**motive**  
Jakość ma znaczenie

SKÓRA  
LEATHER



### REKAWICE ARCTIC OCIEPLANE

Latex coated terry inside working gloves • Перчатки утепленные ARCTIC • Winter Arbeitshandschuhe Gefüttert ARCTIC • Manusi de protectie Arctic

NUMER KATALOGOWY		
010 309	10	12/120

**motive**  
Jakość ma znaczenie

LATEX



### NAKOLANNIKI

Knee pads • Наколенники • Knieschoner • Genunchiere de protectie

NUMER KATALOGOWY	
010 367	1/24

**motive**  
Jakość ma znaczenie



### NAKOLANNIKI GUMOWE

Rubber knee pads • Резиновые наколенники • Knieschoner aus Gummi • Genunchiere de protectie

NUMER KATALOGOWY	
010 365	1/12/24

GUMA  
RUBBER



### NAKOLANNIKI PIANKOWE

PU foam knee-pads • Наколенники на пенной основе • Knieschoner aus weichem Schaum • Genunchiere de protectie din material EVA

NUMER KATALOGOWY	
010 366	1/50

EVA





tested to work



### SPODNIE ADVANCED

Trousers with kneepad pockets Advanced • Брюки с карманами для наколенников Advanced • Hose mit Knietaschen Advanced • Pantaloni cu buzunare pentru genunchi Advanced

NUMER KATALOGOWY		
17179-311-06-82C46		82/46 1
17179-311-06-82C48		82/48 1
17179-311-06-82C50		82/50 1
17179-311-06-82C52		82/52 1
17179-311-06-82C54		82/54 1
17179-311-06-82C56		82/56 1
17179-311-06-82C58		82/58 1
17179-311-06-82C60		82/60 1
17179-311-18-82C46		82/46 1
17179-311-18-82C48		82/48 1
17179-311-18-82C50		82/50 1
17179-311-18-82C52		82/52 1
17179-311-18-82C54		82/54 1
17179-311-18-82C56		82/56 1
17179-311-18-82C58		82/58 1
17179-311-18-82C60		82/60 1
17179-311-18-90C48		90/48 1
17179-311-18-90C50		90/50 1
17179-311-18-90C52		90/52 1
17179-311-18-90C54		90/54 1
17179-311-18-90C56		90/56 1
17179-311-18-90C58		90/58 1
17179-311-33-82C48		82/48 1
17179-311-33-82C50		82/50 1
17179-311-33-82C52		82/52 1
17179-311-33-82C54		82/54 1
17179-311-33-82C56		82/56 1
17179-311-44-82C46		82/46 1
17179-311-44-82C48		82/48 1
17179-311-44-82C50		82/50 1
17179-311-44-82C52		82/52 1
17179-311-44-82C54		82/54 1
17179-311-44-82C56		82/56 1
17179-311-55-82C48		82/48 1
17179-311-55-82C50		82/50 1
17179-311-55-82C52		82/52 1
17179-311-55-82C54		82/54 1
17179-311-55-82C56		82/56 1



### SPODNIE CLASSIC MAXIMUS



Classic Maximus pants • Брюки Classic Maximus • Hose Classic Maximus • Pantaloni Classic Maximus

NUMER KATALOGOWY		
010 611	44	1/20
010 612	46	1/20
010 613	48	1/20
010 614	50	1/20
010 615	52	1/20
010 616	54	1/20
010 617	56	1/20
010 618	58	1/20
010 619	60	1/20
010 620	62	1/20
010 621	64	1/20



### KURTKA CLASSIC MAXIMUS



Classic Maximus jacket • Куртка Classic Maximus • Jacke Classic Maximus  
 • Jacheta Classic Maximus

NUMER KATALOGOWY		
010 600	44	1/20
010 601	46	1/20
010 602	48	1/20
010 603	50	1/20
010 604	52	1/20
010 605	54	1/20
010 606	56	1/20
010 607	58	1/20
010 608	60	1/20
010 609	62	1/20
010 610	64	1/20



### KOSZULA MODAR

Modar shirt • Рубашка Modar • Hemd Modar • Cămașă Modar

NUMER KATALOGOWY		
010 622	39	1/50
010 623	40	1/50
010 624	41	1/50
010 625	42	1/50
010 626	43	1/50
010 627	44	1/50
010 628	45	1/50
010 629	46	1/50



### BUTY BESTBOY BLACK

Safety shoes Bestboy Black • Спецобувь Bestboy Black • Sicherheitsschuhe Bestboy Black • Pantofi de protectie Bestboy Black

NUMER KATALOGOWY		
BBB40	40	1/10
BBB41	41	1/10
BBB42	42	1/10
BBB43	43	1/10
BBB44	44	1/10
BBB45	45	1/10
BBB46	46	1/10



### BUTY CADOR

Safety shoes Cador • Спецобувь Cador • Sicherheitsschuhe Cador • Pantofi de protectie Cador

NUMER KATALOGOWY		
CG40	40	1/10
CG41	41	1/10
CG42	42	1/10
CG43	43	1/10
CG44	44	1/10
CG45	45	1/10
CG46	46	1/10

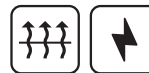



**SAFETY JOGGER**  
INDUSTRIAL



**BUTY CADOR BLACK**

Safety shoes Cador Black • Спецобувь Cador Black • Sicherheitsschuhe Cador Black • Pantofi de protectie Cador Black

NUMER KATALOGOWY		
CS3TLSB40	40	1/10
CS3TLSB41	41	1/10
CS3TLSB42	42	1/10
CS3TLSB43	43	1/10
CS3TLSB44	44	1/10
CS3TLSB45	45	1/10
CS3TLSB46	46	1/10



**SAFETY JOGGER**  
INDUSTRIAL



**BUTY FITZ NAVY**

Safety shoes Fitz Navy • Спецобувь Fitz Navy • Sicherheitsschuhe Fitz Navy • Pantofi de protectie Fitz Navy

NUMER KATALOGOWY		
FN40	40	1/10
FN41	41	1/10
FN42	42	1/10
FN43	43	1/10
FN44	44	1/10
FN45	45	1/10
FN46	46	1/10



**SAFETY JOGGER**  
INDUSTRIAL



**BUTY ECOFITZ NAVY**

Safety shoes EcoFitz Navy • Спецобувь EcoFitz Navy • Sicherheitsschuhe EcoFitz Navy • Pantofi de protectie EcoFitz Navy

NUMER KATALOGOWY		
EFN40	40	1/10
EFN41	41	1/10
EFN42	42	1/10
EFN43	43	1/10
EFN44	44	1/10
EFN45	45	1/10
EFN46	46	1/10



**BUTY OCHRONNE BTEX SB**

Safety shoes Btex SB • Спецобувь Btex SB • Sicherheitsschuhe Btex SB • Pantofi de protectie Btex SB

NUMER KATALOGOWY		
010 739	39	1/10
010 740	40	1/10
010 741	41	1/10
010 742	42	1/10
010 743	43	1/10
010 744	44	1/10
010 745	45	1/10
010 746	46	1/10
010 747	47	1/10





### BUTY SANDAŁY BSSB

Safety sandals • Сандалии рабочие • Sicherheitssandalen • Sandale sigure

NUMER KATALOGOWY		
010 839	39	1/10
010 840	40	1/10
010 841	41	1/10
010 842	42	1/10
010 843	43	1/10
010 844	44	1/10
010 845	45	1/10
010 846	46	1/10
010 847	47	1/10

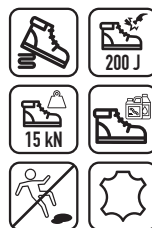

### BUTY CHODAKI

Garden clogs • Сабо • Gartenschuhe • Saboți

NUMER KATALOGOWY		
010 939	39	1/24
010 940	40	1/24
010 941	41	1/24
010 942	42	1/24
010 943	43	1/24
010 944	44	1/24
010 945	45	1/24



### KALOSZE - BUTY BPCV

Wellington boots • Сапоги • Gummistiefel • Cizme

NUMER KATALOGOWY		
010 639	39	1/10
010 640	40	1/10
010 641	41	1/10
010 642	42	1/10
010 643	43	1/10
010 644	44	1/10
010 645	45	1/10
010 646	46	1/10
010 647	47	1/10



### SKARPETY BLACK/YELLOW

Socks • Носки • Socken • Şosete

NUMER KATALOGOWY		
SJS39-42	39-42	1/24
SJS43-47	43-47	1/24



# TABELA ROZMIARÓW



## SPODNIE ADVANCED - Trousers with kneepad pockets Advanced

- Брюки с карманами для наколенников Advanced
- Hose mit Knietaschen Advanced
- Pantaloni cu buzunare pentru genunchi Advanced

	E - cm	L - cm
82/46	82	78
82/48	82	83
82/50	82	88
82/52	82	93
82/54	82	98
82/56	82	103
82/58	82	108
82/60	82	113

## SPODNIE CLASSIC MAXIMUS - Classic Maximus pants

- Брюки Classic Maximus • Hose Classic Maximus
- Pantaloni Classic Maximus

	F - cm	L - cm
82/46	171	80-84
82/48	174	84 - 88
82/50	177	88 - 92
82/52	180	92 - 98
82/54	182	98 - 102
82/56	184	102 - 108
82/58	186	108 - 112
82/60	188	114 - 118

## KURTKA CLASSIC MAXIMUS - Classic Maximus jacket

- Куртка Classic Maximus • Jacke Classic Maximu
- Jacheta Classic Maximus

	F - cm	A - cm
44	167	86 - 90
46	171	90 - 94
48	174	94 - 98
50	177	98 - 102
52	180	102 - 108
54	182	108 - 112
56	184	112 - 118
58	186	118 - 122
60	188	124 - 128
62	193	128 - 132
64	197	132 - 138

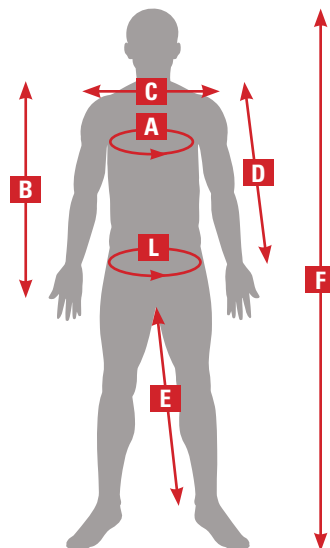

## KOSZULA MODAR - Modar shirt • Рубашка Modar • Hemd Modar • Cămașă Modar

	39	40	41	42	43	44	45	46
A - cm	114	118	122	126	130	134	138	142
B - cm	78	78	80	80	82	82	84	86
C - cm	50	50	52	52	54	54	56	56
D - cm	62	62	64	64	66	66	68	68
F - cm	164 - 170	164 - 170	170 - 176	170 - 176	176 - 182	176 - 182	182 - 188	182 - 188

# TAŚMY

ЛЕНТЫ • TAPES • BÄNDER BENZI • ADEZIVE



# SPECYFIKACJA WYBRANYCH TAŚM



	BLUE MASKING	WHITE MASKING	PRECYZYJNA	LAKIERNICZA	DELIKATNA
	Najpopularniejsza taśma maskująca od Motive. Skutecznie zabezpiecza ściany, ramy okienne, listwy przypodłogowe, narożniki, a także krawędzie ścian i sufitów. Wyróżnia się bardzo dobrymi właściwościami klejącymi. Zero podciekania podczas malowania lub odcinania kolorów.	Taśma maskująca, dzięki której wykleisz idealne łuki czy nawet okręgi. Wykonana jest z papieru krepowanego. Wyróżnia się bardzo dobrymi właściwościami klejącymi, jednocześnie nie pozostawiając śladów kleju po jej zerwaniu.	Taśma dedykowana do klejenia na bardziej wymagające powierzchnie. Idealnie dopasowuje się do wszelkich wyklejanych kształtów. Poza klasycznym malowaniem pędzlem lub wałkiem, można wykorzystać ją w czasie malowania natryskowego.	Taśma wykonana z papieru ryżowego odpornego na wilgoć. Mocny klej idealnie sprawdzi się podczas malowania natryskowego, gdzie istnieje ryzyko poderwania farby. Jednocześnie łatwo ją usunąć, a ponadto nie pozostawia śladów kleju.	Taśma przydatna wtedy, gdy nie mamy pewności jak zostało wcześniej przygotowane nasze podłoże. Delikatny klej zmniejsza ryzyko oderwania taśmy razem z farbą czy tynkiem. Klej jest jednocześnie na tyle mocny, aby bez problemu utrzymać się na ścianie.
Długość	25, 50 m	50 m	50 m	50 m	50 m
Szerokość	18, 25, 30, 38, 48 mm	18, 30, 38, 48 mm	11, 15, 25, 30, 38, 48 mm	25, 30, 38, 48 mm	30, 38, 48 mm
Gdzie stosować?	Wewnątrz i na zewnątrz (ściany, ramy okienne, listwy przypodłogowe, narożniki, krawędzie ścian oraz sufitów)	Wewnątrz i na zewnątrz (ściany, ramy okienne, listwy przypodłogowe, narożniki, krawędzie ścian oraz sufitów)	Wewnątrz i na zewnątrz	Wewnątrz i na zewnątrz (prace lakiernicze)	Wewnątrz i krótkotrwale na zewnątrz (listwy, ramy okienne, płyty meblowe, tworzywa sztuczne, szyby)
Kiedy zrywać?	Po wyschnięciu farby i taśmy (maksymalnie 14 dni na zewnątrz lub 30 dni wewnątrz)	Po wyschnięciu farby i taśmy (maksymalnie 3 dni na zewnątrz lub 7 dni wewnątrz)	Po wyschnięciu farby i taśmy (maksymalnie 7 dni na zewnątrz lub 21 dni wewnątrz)	Po wyschnięciu farby i taśmy (maksymalnie 21 dni)	Po wyschnięciu farby i taśmy





	UV-PE	PROMASK	TYNKARSKA	PVC KARBOWANA LUB GŁADKA
	Taśma wykonana z folii PE do zabezpieczenia powierzchni wewnątrz, jak i na zewnątrz. Jest odporna na promieniowanie UV i dlatego może być ekspozowana na zewnątrz nawet do 30 dni, bez obaw o utratę jej właściwości.	Taśma wzmocniona drobną siatką z włókna, dzięki temu nie zmienia kształtu podczas przypadkowego sklejania się. Jednocześnie łatwo przerywa się pod kątem 90°.	Taśma przeznaczona do zabezpieczenia powierzchni podczas prac tynkarskich i budowlanych. Jest niewrażliwa na warunki atmosferyczne. Taśma o wielu zastosowaniach na placu budowy, w tym również jako taśma reperacyjna.	Taśmy maskujące wykonane z PVC. Polecane do prac malarskich i lekkich budowlanych wewnątrz, jak i na zewnątrz. Taśmy są odporne na wilgoć i przy krótkim ekspozowaniu na promienie UV.
Długość	25, 50 m	25, 50 m	20, 50 m	25 m
Szerokość	38 - 48 mm	38, 48 mm	38, 48 mm 25 mm - wersja do boni	38, 48 mm
Gdzie stosować?	Wewnątrz i na zewnątrz (metal, szkło, plastik, aluminium, drewno)	Wewnątrz i na zewnątrz (stolarka okienna, stal, aluminium, pcv, drewno, szkło)	Wewnątrz i na zewnątrz (tynk, cegła, beton, drewno, pcv, kostka brukowa, powierzchnie gładkie i chropowate)	Wewnątrz i na zewnątrz (metal, szkło, plastik, aluminium, drewno)
Kiedy zrywać?	Od razu po malowaniu lub tynkowaniu* (maksymalnie po 30 dniach)	Najlepiej od razu po malowaniu lub tynkowaniu* (maksymalnie po 30 dniach)	Maksymalnie 14 dni na zewnątrz lub 21 dni wewnątrz	Od razu po malowaniu lub tynkowaniu* (maksymalnie 14 dni na zewnątrz lub 21 dni wewnątrz)

\* taśmy nie należy zrywać w pełnym słońcu i z nagranych powierzchni



**BLUE MASKING TAPE**



Blue masking tape • Лента малярная "BLUE MASKING TAPE"  
• Malerkreppband blau • Banda mascare, rezistenta la UV, albastra

NUMER KATALOGOWY			
020 328	30 mm	25 m	36/3600
020 329	38 mm	25 m	1/24/2520
020 330	48 mm	25 m	1/24/2160
020 311	18 mm	50 m	1/48/2880
020 312	25 mm	50 m	48/2880
020 313	30 mm	50 m	36/3600
020 314	38 mm	50 m	24/2160
020 315	48 mm	50 m	24/2160



**WHITE MASKING TAPE**



White masking tape • Лента малярная "WHITE MASKING TAPE"  
• Kreppband weiß • Banda mascare alb

NUMER KATALOGOWY			
020 334	18 mm	50 m	1/48/3600
020 331	30 mm	50 m	1/36/3600
020 332	38 mm	50 m	1/24/2160
020 333	48 mm	50 m	1/24/2160



**TAŚMA DELIKATNA - LIGHT**



Low tack tape • Лента малярная "LIGHT" • Abdeckband Low Tack  
• Banda mascare, suprafete sensibile

NUMER KATALOGOWY			
020 498	30 mm	50 m	1/48
020 499	38 mm	50 m	1/24
020 500	48 mm	50 m	1/24



**TAŚMA MASKUJĄCA**

Masking tape • Лента малярная на бумажной основе • Abdeckband  
• Banda mascare interior

NUMER KATALOGOWY			
020 150	19 mm	25 m	48/4320
020 151	25 mm	25 m	36/3780
020 152	30 mm	25 m	40/3600
020 153	38 mm	25 m	24/2160
020 154	48 mm	25 m	24/2160
020 165	19 mm	50 m	48/4320
020 166	25 mm	50 m	36/3240
020 167	30 mm	50 m	40/3600
020 168	38 mm	50 m	24/2160
020 169	48 mm	50 m	24/2400



**TAŚMA MASKUJĄCA PRECYZYJNA**Precision masking tape • Точная защитная лента • Kreppband Washitape  
• Banda de mascare Washi-Tape aurié

NUMER KATALOGOWY			
020 341	11 mm	50 m	1/96
020 346	15 mm	50 m	1/48
020 342	25 mm	50 m	1/48
020 343	30 mm	50 m	1/48
020 344	38 mm	50 m	1/24
020 345	48 mm	50 m	1/24

**TAŚMA MASKUJĄCA BLUE**Masking tape • Лента клейк. на бумажной основе • Kreppband Blue  
• Banda mascare Blue

NUMER KATALOGOWY			
020 359	25 mm	50 m	40
020 360	30 mm	50 m	40
020 361	38 mm	50 m	24
020 362	48 mm	50 m	24

**TAŚMA PVC GŁADKA**Smooth surface pvc tape • Лента ПВХ гладкая • Glatt PVC Band  
• Banda mascare PVC

NUMER KATALOGOWY			
020 203	30 mm	25 m	1/36/2880
020 204	38 mm	25 m	1/30/2400
020 205	48 mm	25 m	1/24/1920

**TAŚMA PVC KARBOWANA**PVC easy tear tape, embossed • Лента ПВХ • Quergerillt PVC Band  
• Banda mascare PVC alba

NUMER KATALOGOWY			
020 198	30 mm	25 m	1/36
020 199	38 mm	25 m	1/30
020 200	48 mm	25 m	1/24



**TAŚMA UV-PE**

Polyethylene masking tape • Лента UV-PE • UV-PE Band  
• Banda mascare UV-PE

NUMER KATALOGOWY			
020 207	38 mm	50 m	1/32
020 208	48 mm	25 m	1/24
020 209	48 mm	50 m	1/24



**TAŚMA PE PROMASK**

PE Promask Tape • Лента "PE PROMASK" • Bautenschutzband PE  
• Banda mascare textila PE

NUMER KATALOGOWY			
020 459	38 mm	50 m	1/24
020 457	48 mm	25 m	1/24
020 460	48 mm	50 m	1/24



**TAŚMA DWUSTRONNA**

Double sided adhesive tape, PE foil • Скотч 2-х.стор. на п/п основе  
• Doppelseitiges Klebeband mit Folienträger • Banda dublu adeziva

NUMER KATALOGOWY			
020 125	38 mm	5 m	1/48
020 126	38 mm	10 m	1/48
020 128	50 mm	5 m	1/36
020 129	50 mm	10 m	1/36
020 130	50 mm	25 m	1/24



**TAŚMA DWUSTRONNA WZMOCNIONA**

Double sided adhesive tape, cloth • Скотч 2-х.стор. на тканевой основе  
• Doppelseitiges Klebeband mit Gewebeträger  
• Banda dublu adeziva, suport textil

NUMER KATALOGOWY			
020 120	50 mm	5 m	1/36
020 121	50 mm	10 m	1/36
020 122	50 mm	25 m	1/24

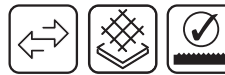

**TAŚMA LAKIERNICZA**

Car painter's masking tape • Термостойкая малярная клейкая лента  
• Lackierband • Banda adeziva pentru vopsitorii auto

NUMER KATALOGOWY			
020 140	25 mm	50 m	1/48
020 141	30 mm	50 m	1/36
020 142	38 mm	50 m	1/24
020 143	48 mm	50 m	1/24





**TAŚMA UNIWERSALNA**

Duct tape, cloth • Лента универсальная • Reparaturband • Banda Duct Tape

NUMER KATALOGOWY			
020 210	50 mm	10 m	1/36
020 211	50 mm	25 m	1/24
020 212	50 mm	50 m	1/12



**TAŚMA UNIWERSALNA STRONG**

Heavy duty duct tape • Лента универсальная "STRONG" • Reparaturband Strong • Banda Duct Tape Strong

NUMER KATALOGOWY			
020 213	48 mm	25 m	1/24
020 214	48 mm	50 m	1/12



**TAŚMA DO KLEJENIA FOLII**

PE-Repairing Tape • Скотч для соединения плёнки • PE Reparaturband • Banda adeziva pentru folie solar

NUMER KATALOGOWY			
020 454	48 mm	20 m	1/24

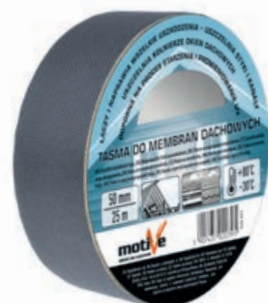

**TAŚMA DO MEMBRAN DACHOWYCH**

Breather membrane tape • Лента для мембран • Einseitiges Klebeband für Unterspannbahnen • Banda reparatii membrane acoperis

NUMER KATALOGOWY			
020 451	50 mm	25 m	1/6



**TAŚMA TYNKARSKA**

Plastering and roughcasting tape • Лента штукатурная • Putzband • Banda adeziva pentru tencuieli



NUMER KATALOGOWY			
020 131	38 mm	20 m	1/24
020 132	48 mm	20 m	1/24
020 133	38 mm	50 m	1/28
020 134	48 mm	50 m	1/24





**TAŚMA TYNKARSKA STRONG**

Plastering and roughcasting tape • Лента штукатурная • Putzband  
• Banda adeziva pentru tencuieli

NUMER KATALOGOWY			
020 033	38 mm	50 m	1/32
020 034	48 mm	50 m	1/24



**TAŚMA TYNKARSKA DO BONI**



Plastering tape for rustication • Лента для рустовки штукатурки  
• Putzband • Banda adeziva pentru tencuieli

NUMER KATALOGOWY			
020 455	25 mm	50 m	1/48



**TAŚMA ELEWACYJNA**



Plastering tape for rustication • Лента для рустовки штукатурки  
• Putzband • Banda adeziva pentru tencuieli

NUMER KATALOGOWY			
020 240	38 mm	20 m	1/24
020 241	48 mm	20 m	1/24
020 242	38 mm	50 m	1/28
020 243	48 mm	50 m	1/24
020 244	48 mm	50 y	1/24



**TAŚMA ŁĄCZENIOWA**



Drywall joint tape • Лента серпянка • Gitterband selbstklebend  
• Banda autoadeziva pentru imbinare

NUMER KATALOGOWY			
020 111	50 mm	10 m	1/60
020 112	50 mm	20 m	1/60
020 113	50 mm	45 m	1/54
020 114	50 mm	90 m	1/24
020 115	50 mm	153 m	1/12
020 118	48 mm	82 m	1/24



**TAŚMA REPERACYJNA**

Drywall joint tape • Лента ремонтная из стекловолокна • Gitterband selbstklebend • Banda autoadeziva pentru imbinare

NUMER KATALOGOWY			
020 108	200 mm	20 m	1/12
020 109	100 mm	20 m	1/24
020 110	150 mm	20 m	1/24

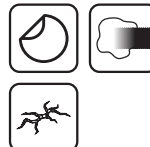



**motive**   
Jakość ma znaczenie



**TAŚMA Z WŁÓKNA SZKLANEGO**

Fiberglass tissue tape • Стеклохолст „Паутинка” • Glasfasermatte  
• Banda fibra sticla pentru imbinare

NUMER  
KATALOGOWY



020 226

1 m

25 m

25/100/2100



**motive**   
Jakość ma znaczenie



**TAŚMA Z WŁÓKNA SZKLANEGO**

Fiberglass tissue tape • „Флизелин” - лента из стекловолокна для г/к несамокл • Glasfaserband • Banda fibra sticla pentru imbinare

NUMER  
KATALOGOWY



020 225

50 mm

25 m

1/100/1300

020 224

150 mm

25 m

1/50



**motive**   
Jakość ma znaczenie



**TAŚMA ŚLIZGOWA**

Plasterboard tape • Лента разделительная • Trennband • Banda gips carton

NUMER  
KATALOGOWY



020 186

50 mm

50 m

1/36



**motive**   
Jakość ma znaczenie



**TAŚMA ŚLIZGOWA**

Plasterboard tape • Лента разделительная • Trennband • Banda gips carton

NUMER  
KATALOGOWY



020 188

48 mm

60 m

1/36



**TAŚMA ANTYRYSOWA**

Anti scratch self adhesive fiberglass tape • Лента ремонтная  
• Anti-Rissband • Banda pentru imbinare

NUMER  
KATALOGOWY



020 105

50 mm

10 m

1/52



**TAŚMA PAPIEROWA**

Plasterboard paper joint tape • Лента углоформирующая бумаж.  
• Fugendeckstreifen mit Perforation • Banda hartie pentru finisare



NUMER  
KATALOGOWY



020 195

50 mm

75 m

1/24

**TAŚMA Z WKŁADKĄ METALOWĄ**

Metal corner tape • Лента с метал. вкладкой • Metall Kantenschutz  
• Banda pentru protectia colturilor



NUMER  
KATALOGOWY



020 220

50 mm

30 m

1/10

**TAŚMA Z WKŁADKĄ ALUMINIOWĄ**

Aluminum corner tape • Лента с алюм. вкладкой • Alu Kantenschutz  
• Banda aluminiu pentru protectia colturilor

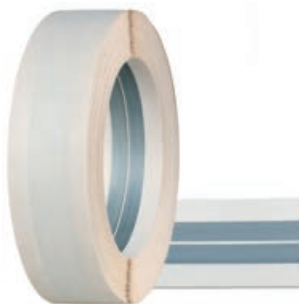

NUMER  
KATALOGOWY



020 221

50 mm

30 m

1/10

**TAŚMA SIME ŁĄCZENIOWA Q**

Drywall joint tape Q • Лента самокл. Q • Съединителна лента Q  
• Lipni juosta Q • Armierungsband Sime Q



NUMER  
KATALOGOWY



020 317

50 mm

12 m

1/12

020 318

50 mm

25 m

1/18

**TAŚMA SIME NAROŻNIKOWA V**

Drywall corner tape V • Лента самокл. V • Съединителна лента V  
• Lipni juosta V • Armierungsband Sime V



NUMER  
KATALOGOWY



020 319

50 mm

12 m

1/12

020 320

50 mm

25 m

1/18

**TAŚMA AKUSTYCZNA**Foam adhesive tape • Лента акустическая, клейкая • Trennwandband  
• Banda adeziva pentru etansareNUMER  
KATALOGOWY

020 100	30 mm	30 m	1/32
020 101	50 mm	30 m	1/18
020 102	70 mm	30 m	1/14
020 103	95 mm	30 m	1/10

**TAŚMA MONTAŻOWA ZEWNĘTRZNA**Outdoor mounting tape • Скотч 2-х.стор. на вспененной основе  
• Doppelseitiges Montageband • Banda dublu adeziva pentru fixareNUMER  
KATALOGOWY

020 175	czarna/black	12 mm	5 m	1/20
020 176	czarna/black	19 mm	5 m	1/20

**TAŚMA MONTAŻOWA WEWNĘTRZNA**Indoor mounting tape • Скотч 2-х.стор. на вспененной основе  
• Doppelseitiges Montageband • Banda dublu adeziva pentru fixareNUMER  
KATALOGOWY

020 177	biała/white	12 mm	5 m	1/20
020 178	biała/white	19 mm	5 m	1/20

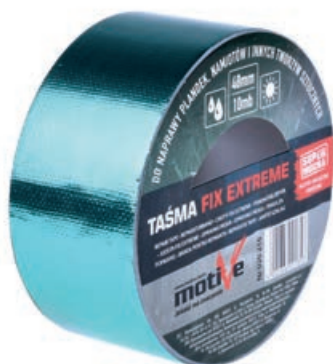
**TAŚMA FIX EXTREME**Repair tape • Лента ремонтная "FIX EXTREME" • Reparaturklebeband für  
Gewebeplanen • Banda adeziva, pentru reparatii Fix ExtremeNUMER  
KATALOGOWY

020 216	48 mm	10 m	1/36
---------	-------	------	------

**TAŚMA POWER FIX**Power Fix tape • Лента ремонтная "POWER FIX" • Doppelseitiges  
Montageklebeband • Banda dublu adeziva pentru fixareNUMER  
KATALOGOWY

020 174	19 mm	1,5 m	1/32
---------	-------	-------	------



**TAŚMA IZOLACYJNA**

Insulating tape • Изолента чёрная • Isolierband-schwarz  
• Banda izolatoare neagra



NUMER  
KATALOGOWY



020 136

19 mm

10 m

10/300



**TAŚMA IZOLACYJNA KOLOR**

Insulating tape • Изолента цветная • Isolierband- bunt • Banda izolatoare



NUMER  
KATALOGOWY



020 135

15 mm

10 m

10/300



**TAŚMA USZCZELNIAJĄCA PTFE**

Sealing up teflon tape/PTFE thread seal tape • Лента герметизирующая  
тефлоновая • PTFE Band • Banda PTFE



NUMER  
KATALOGOWY

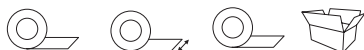

020 173

x10

12 mm

10 m

10/1000



**TAŚMA DO OTULIN**

Duct tape • Лента универсальная • Reparaturband • Banda adeziva duct



NUMER  
KATALOGOWY



020 260



48 mm

50 m

1/24

020 261



48 mm

50 m

1/24



**TAŚMA METALIZOWANA**

Metalized tape • Лента клейкая металлизированная • Alu- PP Klebeband  
• Bandă adezivă de aluminiu



NUMER  
KATALOGOWY



020 170

50 mm

50 m

1/96



**TAŚMA ALUMINIOWA 110°C**

Aluminium tape • Лента алюминиевая • Aluminiumband • Banda adeziva, pentru reparatii, din aluminiu

NUMER KATALOGOWY			
020 106	48 mm	45 m	1/24
020 096	48 mm	25 m	1/30

**TAŚMA ALUMINIOWA 350°C**

Aluminium tape • Лента алюминиевая • Aluminiumband • Banda adeziva, pentru reparatii, din aluminiu

NUMER KATALOGOWY			
020 104	50 mm	25 m	1/30
020 107	50 mm	50 m	1/24

**TAŚMA ANTYPOŚLIZGOWA CZARNA**

Anti Slip tape - black • Лента противоскользящая • Anti-Rutsch Klebeband • Banda adeziva antialunecare

NUMER KATALOGOWY			
020 217	50 mm	5 m	1/24

**TAŚMA ANTYPOŚLIZGOWA FLUO**

Anti Slip tape - FLUO • Лента противоскользящая с флуоресцентной вставкой • Anti-Rutsch Klebeband • Banda antialunecare fluorescenta

NUMER KATALOGOWY			
020 218	50 mm	5 m	1/24

**TAŚMA ANTYPOŚLIZGOWA FLUO**

Anti Slip tape • Лента противоскользящая • Anti-Rutsch Klebeband • Banda antialunecare

NUMER KATALOGOWY			
020 222	50 mm	5 m	1/24



**TAŚMA ANTYPOŚLIZGOWA CLEAR (BEZBARWNA)**

Anti Slip tape • Противоскользящая лента • Anti-Rutschband  
• Banda adeziva antialunecare

NUMER KATALOGOWY			
020 219	25 mm	5 m	1/48

**motive**  
Jakość ma znaczenie



**TAŚMA OSTRZEGAWCZA**

Heavy duty warning tape • Лента сигнальная • Warnband rot/weiß  
• Banda delimitare dungii rosu

NUMER KATALOGOWY			
020 189	100 mm	100 m	1/18

**motive**  
Jakość ma znaczenie

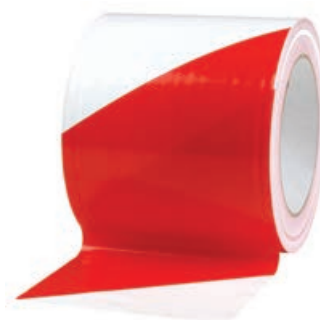

**TAŚMA OSTRZEGAWCZA**

Hazard warning tape • Лента сигнальная • Warnband rot/weiß  
• Banda delimitare dungii rosu

NUMER KATALOGOWY			
020 190	75 mm	100 m	1/24
020 193	80 mm	200 m	1/30
020 194	80 mm	500 m	1/16



**TAŚMA OSTRZEGAWCZA KLEJĄCA**

Hazard warning tape, black/yellow self adhesive • Лента сигнальная жел./черн. клейкая • Warnklebeband schwarz / gelb • Banda adeziva delimitare negru/galben

NUMER KATALOGOWY			
020 192	48 mm	25 m	1/24

**motive**  
Jakość ma znaczenie



**TAŚMA OSTRZEGAWCZA KLEJĄCA**

Hazard warning tape, white/red self adhesive • Лента сигнальная белая/красная клейкая • Warnklebeband rot/weiß • Banda adeziva delimitare alb/roșu

NUMER KATALOGOWY			
020 228	48 mm	25 m	1/24

**motive**  
Jakość ma znaczenie



**TAŚMA OSTRZEGAWCZA ŻÓŁTO-CZARNA**

Hazard warning tape, black/yellow • Лента сигнальная жел./черн.  
• Warnband schwarz/gelb • Banda delimitare dungii negru/galben

NUMER  
KATALOGOWY



020 191

80 mm

100 m

1/42

**TAŚMA OPAKOWANIOWA BEZBARWNA**

Packing tape transparent • Скотч бесцветный • Packband transparent  
• Banda adeziva pentru ambalare transparenta

NUMER  
KATALOGOWY



020 181

48 mm

40 m

6/36

**TAŚMA OPAKOWANIOWA BIAŁA**

Packaging tape white • Скотч белый • Packband weiß  
• Banda adeziva pentru ambalare alba

NUMER  
KATALOGOWY



020 182

48 mm

40 m

6/36

**TAŚMA OPAKOWANIOWA BRĄZOWA**

Packing tape brown • Клейкая лента (скотч) • Packband, braun  
• Banda adeziva pentru ambalare maro

NUMER  
KATALOGOWY



020 180

48 mm

40 m

6/36

020 185

48 mm

60 m

6/36

**TAŚMA DO KLEJENIA KARTONU**

Packing tape • Скотч • Packband • Banda adeziva pentru ambalare

NUMER  
KATALOGOWY



020 184

48 mm

60 m

6/36





**TAŚMA OPAKOWANIOWA BEZSZELESTNA**

Low noise packing tape • Скотч бесшумный • PP-Packband leise abrollend  
• Banda adeziva pentru ambalare



NUMER  
KATALOGOWY

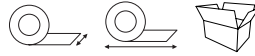

020 179

48 mm

66 m

6/36

**TAŚMA DO KLEJENIA KARTONU**

Packing tape • Скотч • Packband • Banda adeziva PP



NUMER  
KATALOGOWY



020 440

96 mm

60 m

1/18

**TAŚMA OPAKOWANIOWA Z INDYWIDUALNYM NADRUKIEM**

Packing tape with personalized printing logo • Скотч с индивидуальной печатью • Packband mit Logo • Banda pentru ambalare



NUMER  
KATALOGOWY



9876

48 mm

60 m

36

**DYSPENSER**

Tape gun • Диспенсер • Packband Handabroller  
• Dispenser banda adeziva pentru ambalare



NUMER  
KATALOGOWY



020 187

1/24

**SIATKA DO DOCIEPLEŃ 145 g/m<sup>2</sup>**

Fiberglass mesh • Строительная сетка для утепления  
• Armierungsgewebe • Plasă fibra sticlă



NUMER  
KATALOGOWY



090 180

1 m

50 m

50/1500 m<sup>2</sup>



# ARTYKUŁY MALARSKIE

МАЛЯРНЫЕ ИНСТРУМЕНТЫ • PAINTING TOOLS AND ACCESSORIES

• MALERWERKZEUGE • UNELTE DE ZUGRAVIT



# JAKI WAŁEK, DO JAKICH FARB?

		DOSTĘPNE DŁUGOŚCI	DŁUGOŚĆ WŁOSIA	DO JAKICH POWIERZCHNI GŁADKICH, CHROPOWATYCH, CZY NIERÓWNYCH			RODZAJ WŁOSIA	NA JAKI UCHWYT	DO JAKICH FARB I LAKIERÓW
<b>WAŁKI KLASYCZNE</b>									
NYLON FLOOR		18 cm 25 cm	4 mm				NYLON	8 mm	do farb, lakierów i żywic na bazie agresywnych rozpuszczalników, ale również do farb wodnych
VELUR		18 cm 25 cm	4 mm				VELUR	8 mm	do farb, lakierów i żywic na bazie agresywnych rozpuszczalników, ale również do farb wodnych
SPRINGFIELD		18 cm 25 cm	9 mm				MICROFIBRA	8 mm	do farb, emulsji i impregnatów na bazie wody, do farb akrylowych i lateksowych
GREENFIELD		18 cm 25 cm	10 mm				MICROFIBRA	8 mm	do farb, emulsji i impregnatów na bazie wody, do farb akrylowych i lateksowych
MICROGREEN		18 cm 25 cm	10 mm				POLIAMID ENDLESS	8 mm	do farb, emulsji i impregnatów na bazie wody, do farb akrylowych i lateksowych
MICROSTAR		18 cm 25 cm 38 cm	10 mm				POLIESTER	8 mm	do farb, emulsji i impregnatów na bazie wody, do farb akrylowych i lateksowych
SILVERAMID		18 cm 25 cm	12 mm				POLIAMID ENDLESS	8 mm	do farb, emulsji i impregnatów na bazie wody, do farb akrylowych i lateksowych
GOLDLINE		18 cm 25 cm	12 mm				POLYACRYL	8 mm	do farb, lakierów i żywic na bazie agresywnych rozpuszczalników, ale również do farb wodnych
VOLCANO		18 cm 25 cm	13 mm				POLIAMID	8 mm	do farb, lakierów i żywic na bazie agresywnych rozpuszczalników, ale również do farb wodnych
NYLON		18 cm 25 cm 38 cm	14 mm				NYLON	8 mm	do farb, lakierów i żywic na bazie agresywnych rozpuszczalników, ale również do farb wodnych
ARCTIC		18 cm 25 cm	14 mm				NYLON	8 mm	do farb, lakierów i żywic na bazie agresywnych rozpuszczalników, ale również do farb wodnych
BLUECOLOR		18 cm 25 cm	18 mm				POLIAKRYL	8 mm	do farb, emulsji i impregnatów na bazie wody, do farb akrylowych i lateksowych
BLUECOLOR FASADOWY		18 cm 25 cm	18 mm				POLIAKRYL	8 mm	do farb, emulsji i impregnatów na bazie wody, do farb akrylowych i lateksowych
POLIGREEN		18 cm 25 cm	18 mm				POLIAKRYL	8 mm	do farb, emulsji i impregnatów na bazie wody, do farb akrylowych i lateksowych
VOLCANO MAX		18 cm 25 cm	21 mm				POLIAMID	8 mm	do farb, lakierów i żywic na bazie agresywnych rozpuszczalników, ale również do farb wodnych
<b>SERIA V-PRO (KLASYCZNE I KOSZYKOWE)</b>									
V-PRO FIBRA		10 cm 23 cm 40 cm	10 mm				MICROFIBRA	6 mm 8 mm 19 mm 38 mm	do farb, emulsji i impregnatów na bazie wody, do farb akrylowych i lateksowych
V-PRO NYLON		10 cm 23 cm 40 cm	11 mm				NYLON	6 mm 8 mm 19 mm 38 mm	do farb, lakierów i żywic na bazie agresywnych rozpuszczalników, ale również do farb wodnych
V-PRO MOHAIR		10 cm 23 cm 40 cm	4 mm 10 mm				MOHAIR	6 mm 8 mm 19 mm 38 mm	do farb, lakierów i żywic na bazie agresywnych rozpuszczalników, ale również do farb wodnych
V-PRO PES		10 cm 23 cm 40 cm	12 mm				POLIESTER	6 mm 8 mm 19 mm 38 mm	do farb, emulsji i impregnatów na bazie wody, do farb akrylowych i lateksowych
V-PRO WHITE FIBRA		10 cm 23 cm 40 cm	14 mm 18 mm				MICROFIBRA	6 mm 8 mm 19 mm 38 mm	do farb, emulsji i impregnatów na bazie wody, do farb akrylowych i lateksowych

# SZEROKOŚCI W MALOWANIU!

**SZEROKI UCHWYT DO WAŁKÓW.** Dedykowany dla tych, którzy malują duże powierzchnie. Dzięki niemu oraz szerokiemu wałkowi pomalowane metry kwadratowe pojawiają się jeden za drugim. Regulowane ramiona pozwalają zamocować wałki o szerokości nawet do 50 cm. Ergonomiczna i wygodna rękojeść wyposażona jest w gwint współpracujący z większością kijów teleskopowych.

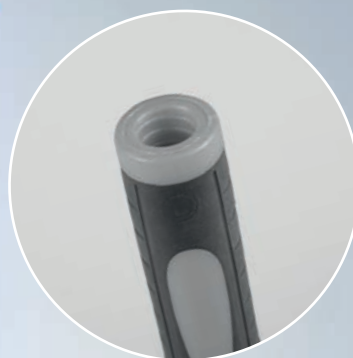
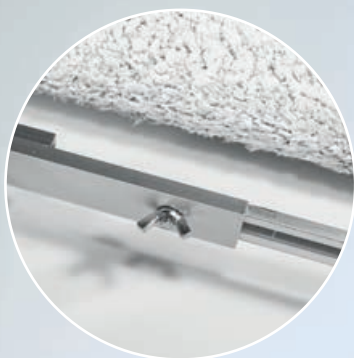

Regulacja rozstawu i szybka blokada przy pomocy dwóch śrub motylkowych

Ergonomiczny uchwyt z gwintem do kijów teleskopowych

Sztywny anodowany na srebro profil aluminiowy

nr kat. 030 413

WAŁKI OD 30 cm DO 50 cm

# NOWY MODEL MYJKI DO WAŁKÓW MALARSKICH I PĘDZLI

## UNIWERSALNA

Bo użyjesz ją do większości wałków i pędzli, które wykorzystujesz podczas prac malarskich

## PROSTA W UŻYCIU

Bo do mycia wystarczy dostęp do węża z bieżącą wodą i wadro. Może to być wąż ogrodowy lub prysznicowy. Kranik przyłączem jest w zestawie z myjką

## PRZEMYŚLANA

Bo posiada mocowania, które dopasowane są do większości okrągłych wiader po farbach, masach szpachlowych lub gipsach

## EKOLOGICZNA

Bo do umycia narzędzi zużyjesz mniej niż 10 litrów wody



**NOWOŚĆ**

ULEPSZONA,  
ELASTYCZNA  
I SZCZELNA  
POKRYWA

DYSZA  
ROZPRASZAJĄCA  
STRUMIEN WODY  
PODCZAS MYCIA  
PĘDZLI

TARKA  
NA DNIĘ MYJKI  
DO MYCIA PĘDZLI

KRANIK DO  
REGULACJI  
STRUMIENIA WODY  
Z PRZYŁĄCZEM  
DO WĘŻA



**WKŁAD VOLCANO (2 SZT.)**

2 x VOLCANO roller refill • 2 x Минивалик "VOLCANO"  
 • 2 x Kleinflächenwalze Volcano • 2 x Rola poliamida Volcano

NUMER KATALOGOWY					
030 701	10 cm	18 mm	13 mm	6 mm	1/500

**WALEK VOLCANO**

VOLCANO roller refill • Валик "VOLCANO" запас • Malerwalze Volcano  
 • Rola poliamida Volcano

NUMER KATALOGOWY					
030 600	18 cm	48 mm	13 mm	8 mm	1/75
030 601	25 cm	48 mm	13 mm	8 mm	1/50

**WALEK VOLCANO MAX**

VOLCANO MAX roller refill • Валик "VOLCANO MAX" запас • Fassaden-Malerwalze Volcano Max • Rola de fatada poliamida Volcano MAX

NUMER KATALOGOWY					
030 602	18 cm	48 mm	21 mm	8 mm	1/75
030 603	25 cm	48 mm	21 mm	8 mm	1/50

**WKŁAD SPRINGFIELD (2 SZT.)**

2 x SPRINGFIELD roller refill • 2 x Минивалик "SPRINGFIELD"  
 • 2 x Kleinflächenwalze Springfield • 2 x Rola Springfield

NUMER KATALOGOWY					
030 705	10 cm	18 mm	9 mm	6 mm	1/500

**WALEK SPRINGFIELD**

SPRINGFIELD roller refill • Валик "SPRINGFIELD" запас • Malerwalze Springfield  
 • Rola Springfield

NUMER KATALOGOWY					
030 610	18 cm	48 mm	9 mm	8 mm	1/75
030 611	25 cm	48 mm	9 mm	8 mm	1/50





**WKŁAD SILVERAMID (2 SZT.)**

2 x SILVERAMID roller refill • 2 x Минивалик "SILVERAMID"  
• 2 x Kleinflächenwalze Silveramid • 2 x Rola Silveramid

NUMER KATALOGOWY					
030 715	10 cm	18 mm	12 mm	6 mm	1/500



**WAŁEK SILVERAMID**

SILVERAMID roller refill • Валик "SILVERAMID" запас • Malerwalze Silveramid  
• Rola Silveramid

NUMER KATALOGOWY					
030 614	18 cm	48 mm	12 mm	8 mm	1/75
030 615	25 cm	48 mm	12 mm	8 mm	1/50



**WAŁEK BLUECOLOR**

BLUECOLOR roller refill • Валик "BLUECOLOR" запас • Malerwalze Bluecolor  
• Rola Bluecolor

NUMER KATALOGOWY					
030 232	18 cm	48 mm	18 mm	8 mm	1/75
030 233	25 cm	48 mm	18 mm	8 mm	1/50



**WAŁEK BLUECOLOR FASADOWY**

BLUECOLOR roller refill + foam • Ролка "BLUECOLOR" фасад  
• Fassaden-Malerwalze Bluecolor • Rola de fatada Bluecolor

NUMER KATALOGOWY						
030 234	18 cm	48 mm	18 mm	4 mm	8 mm	1/50
030 235	25 cm	48 mm	18 mm	4 mm	8 mm	1/50



**WKŁAD POLIGREEN (2 SZT.)**

2 x POLIGREEN roller refill • 2 x Минивалик "POLIGREEN"  
• 2 x Kleinflächenwalze Poligreen • 2 x Rola Poligreen

NUMER KATALOGOWY					
030 292	10 cm	18 mm	12 mm	6 mm	1/100





### WAŁEK POLIGREEN

POLIGREEN roller refill • Валик фасадный "POLIGREEN" запас  
• Malerwalze Poligreen • Rola Poligreen

NUMER KATALOGOWY					
030 286	18 cm	48 mm	18 mm	8 mm	1/10
030 287	25 cm	48 mm	18 mm	8 mm	1/10

**motive**  
Jakość ma znaczenie

POLYACRYL

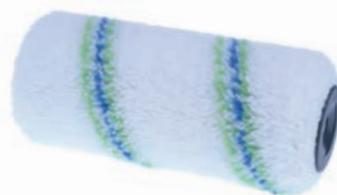

### WKŁAD ARCTIC (2 SZT.)

2 x ARCTIC roller refill • 2 x Минивалик "ARCTIC" • 2 x Kleinflächenwalze Arctic  
• 2 x Rola Arctic

NUMER KATALOGOWY					
030 718	10 cm	18 mm	18 mm	6 mm	1/500

**motive**  
Jakość ma znaczenie

NYLON PESH MIX

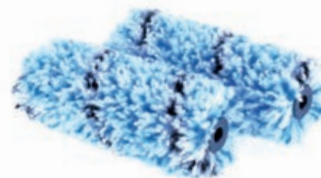

### WAŁEK ARCTIC

ARCTIC roller refill • Валик "ARCTIC" запас • Malerwalze Arctic • Rola Arctic

NUMER KATALOGOWY					
030 606	18 cm	48 mm	14 mm	8 mm	1/75
030 607	25 cm	48 mm	14 mm	8 mm	1/50

**motive**  
Jakość ma znaczenie

NYLON PESH MIX



### WAŁEK GREENFIELD

GREENFIELD roller refill • Валик "GREENFIELD" запас • Malerwalze Greenfield  
• Rola Greenfield

NUMER KATALOGOWY					
030 604	18 cm	48 mm	10 mm	8 mm	1/75
030 605	25 cm	48 mm	10 mm	8 mm	1/50

**motive**  
Jakość ma znaczenie

MICROFIBRE



### WKŁAD MICROGREEN (2 SZT.)

2 x MICROGREEN roller refill • 2 x Минивалик "MICROGREEN"  
• 2 x Kleinflächenwalze Microgreen • 2 x Rola Microgreen

NUMER KATALOGOWY					
030 291	10 cm	18 mm	10 mm	6 mm	1/300

**motive**  
Jakość ma znaczenie

POLYAMIDE ENDLESS

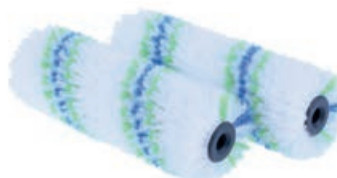

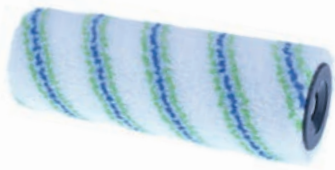

**motive**   
Jakość ma znaczenie

**POLYAMIDE  
ENDLESS**



**WAŁEK MICROGREEN**

MICROGREEN roller refil • Валик "MICROGREEN" запас  
• Malerwalze Microgreen • Rola Microgreen

NUMER KATALOGOWY					
030 284	18 cm	48 mm	10 mm	8 mm	1/10
030 285	25 cm	48 mm	10 mm	8 mm	1/10



**motive**   
Jakość ma znaczenie

**POLYESTER**



**WKŁAD MICROSTAR (2 SZT.)**

2 x Mini MICROSTAR roller refil • 2 x Минивалик "MICROSTAR"  
• 2 x Kleinflächenwalze Microstar • 2 x Rola Microstar

NUMER KATALOGOWY					
030 290	7 cm	17 mm	10 mm	6 mm	1/300
030 263	10 cm	17 mm	10 mm	6 mm	1/300
030 264	15 cm	17 mm	10 mm	6 mm	1/250



**motive**   
Jakość ma znaczenie

**POLYESTER**



**WKŁAD MICROSTAR MIDI (2 SZT.)**

2 x Midi MICROSTAR roller refil • 2 x Минивалик "MICROSTAR MIDI"  
• 2 x Kleinflächenwalze Microstar midi • 2 x Rola Microstar Midi

NUMER KATALOGOWY					
030 272	10 cm	30 mm	10 mm	6 mm	1/200
030 273	15 cm	30 mm	10 mm	6 mm	1/200



**motive**   
Jakość ma znaczenie

**POLYESTER**



**WAŁEK MICROSTAR**

MICROSTAR roller refil • Валик "MICROSTAR" запас • Malerwalze Mirostar  
• Rola Microstar

NUMER KATALOGOWY					
030 240	18 cm	48 mm	10 mm	8 mm	1/50
030 241	25 cm	48 mm	10 mm	8 mm	1/50



**motive**   
Jakość ma znaczenie

**POLYESTER**



**WAŁEK MICROSTAR**





MICROSTAR roller refil • Валик "MICROSTAR" запас • Malerwalze Mirostar  
• Rola Microstar

NUMER KATALOGOWY					
030 613	38 cm	48 mm	9 mm	8 mm	1/50







**WAŁEK GOLDLINE**

GOLDLINE roller refill • Валик "GOLDLINE" запас • Malerwalze Goldfaden  
 • Rola Goldline

NUMER KATALOGOWY					
030 247	18 cm	48 mm	12 mm	8 mm	1/50
030 248	25 cm	48 mm	12 mm	8 mm	1/50





**WKŁAD NYLON ( 2 SZT.)**

2 x Mini NYLON roller refill • 2 x Минивалик "NYLON" • 2 x Mini volelis NYLON"  
 • 2 x Kleinflächenwalze Nylon • 2 x Rola Nylon

NUMER KATALOGOWY					
030 260	7 cm	17 mm	14 mm	6 mm	1/500
030 261	10 cm	17 mm	14 mm	6 mm	1/300
030 262	15 cm	17 mm	14 mm	6 mm	1/250





**WKŁAD NYLON MIDI (2 SZT.)**

2 x Midi NYLON roller refill • 2 x Минивалик "NYLON MIDI"  
 • 2 x Kleinflächenwalze Midi Nylon • 2 x Rola Nylon Midi

NUMER KATALOGOWY					
030 270	10 cm	30 mm	14 mm	6 mm	1/200
030 271	15 cm	30 mm	14 mm	6 mm	1/200





**WAŁEK NYLON**

NYLON roller refill • Валик "NYLON" запас • Malerwalze Nylon

NUMER KATALOGOWY					
030 012	18 cm	48 mm	14 mm	8 mm	1/50
030 013	25 cm	48 mm	14 mm	8 mm	1/50

**WAŁEK NYLON**

NYLON roller refill • Валик "NYLON" запас • Malerwalze Nylon

NUMER KATALOGOWY					
030 005	38 cm	48 mm	14 mm	8 mm	1/50





#### WALEK NYLON FLOOR

NYLON FLOOR roller refill • Валик "NYLON FLOOR" запас  
• Malerwalze Nylon Floor • Rola Nylon Floor

NUMER KATALOGOWY					
030 280	18 cm	48 mm	4 mm	8 mm	1/10
030 281	25 cm	48 mm	4 mm	8 mm	1/10

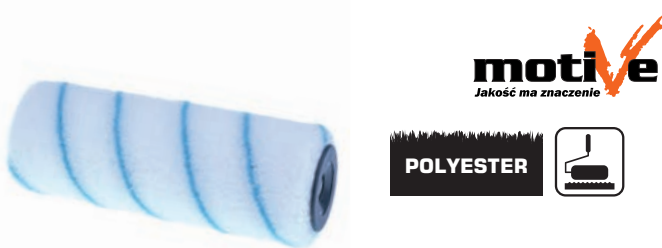

#### WALEK POLIAZUR

POLIAZUR roller refill • Валик "POLIAZUR" запас • Malerwalze Poliazur  
• Rola Poliazur

NUMER KATALOGOWY					
030 608	18 cm	48 mm	12 mm	8 mm	1/75
030 609	25 cm	48 mm	12 mm	8 mm	1/50



#### WKŁAD VELUR (2 SZT.)

2 x Mini VELUR roller refill • 2 x Минивалик "VELUR"  
• 2 x Kleinflächenwalze Velour • 2 x Rola Velur

NUMER KATALOGOWY					
030 257	7 cm	17 mm	4 mm	6 mm	1/500
030 258	10 cm	17 mm	4 mm	6 mm	1/250
030 259	15 cm	17 mm	4 mm	6 mm	1/250



#### WKŁAD MIDI VELUR (2 SZT.)

2 x Midi VELUR roller refill • 2 x Минивалик "VELUR MIDI"  
• 2 x Kleinflächenwalze Midi Velour • 2 x Rola Velur Midi

NUMER KATALOGOWY					
030 268	10 cm	30 mm	4 mm	6 mm	1/200
030 269	15 cm	30 mm	4 mm	6 mm	1/200

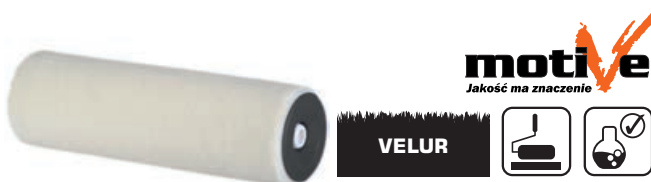

#### WALEK VELUR

VELUR roller refill • Валик "VELUR" запас • Ролка VELUR • Volelis VELUR  
• Malerwalze Velur • Rola Velur

NUMER KATALOGOWY					
030 236	18 cm	48 mm	4 mm	8 mm	1/50
030 237	25 cm	48 mm	4 mm	8 mm	1/50



### WAŁEK MALARSKI WHITE FIBRA

White Microfibre roller refill • Валик "WHITE FIBRA" запас  
• Malerwalze Microfibre weiß • Rola White Fibra

NUMER KATALOGOWY					
		Length	Width	Height	
030 630	10 cm	-	19 mm	14 mm	1/100
030 631	10 cm	-	19 mm	18 mm	1/100
030 634	10 cm	6 mm	-	14 mm	1/100
030 635	10 cm	6 mm	-	18 mm	1/100
030 625	23 cm	-	38 mm	14 mm	1/36
030 627	23 cm	-	38 mm	18 mm	1/12
030 618	23 cm	8 mm	-	14 mm	1/36
030 619	23 cm	8 mm	-	18 mm	1/36
030 742	40 cm	8 mm	-	14 mm	1/12
030 741	40 cm	8 mm	-	18 mm	1/12

### WAŁEK MALARSKI FIBRA

Green Microfibre roller refill • Валик "FIBRA" • Malerwalze Microfibre grün • Rola Fibra

NUMER KATALOGOWY					
		Length	Width	Height	
030 640	10 cm	-	19 mm	10 mm	1/100
030 641	10 cm	6 mm	-	10 mm	1/100
030 620	23 cm	-	38 mm	10 mm	1/36
030 617	23 cm	8 mm	-	10 mm	1/36
030 740	40 cm	8 mm	-	10 mm	1/12

### WAŁEK MALARSKI MOHAIR

Mohair roller refill • Валик "MOHAIR" запас • Malerwalze Mohair • Rola Mohair

NUMER KATALOGOWY					
		Length	Width	Height	
030 675	10 cm	-	19 mm	4 mm	1/100
030 677	10 cm	-	19 mm	10 mm	1/100
030 676	10 cm	6 mm	-	4 mm	1/100
030 678	10 cm	6 mm	-	10 mm	1/100
030 670	23 cm	8 mm	-	4 mm	1/36
030 671	23 cm	8 mm	-	10 mm	1/36
030 680	23 cm	-	38 mm	4 mm	1/36
030 681	23 cm	-	38 mm	10 mm	1/36
030 743	40 cm	8 mm	-	4 mm	1/12
030 744	40 cm	8 mm	-	10 mm	1/12

### WAŁEK KOSZYKOWY NYLON

Nylon roller refill • Валик "NYLON" • Malerwalze nylon • Rola Nylon

NUMER KATALOGOWY					
		Length	Width	Height	
030 650	10 cm	-	19 mm	11 mm	1/100
030 651	10 cm	6 mm	-	11 mm	1/100
030 621	23 cm	-	38 mm	11 mm	1/36
030 673	23 cm	8 mm	-	11 mm	1/36
030 746	40 cm	8 mm	-	11 mm	1/12

### WAŁEK KOSZYKOWY PES

PES roller refill • Валик "PES" • Malerwalze PES • Rola PES

NUMER KATALOGOWY					
		Length	Width	Height	
030 660	10 cm	-	19 mm	12 mm	1/100
030 661	10 cm	6 mm	-	12 mm	1/100
030 622	23 cm	-	38 mm	12 mm	1/36
030 672	23 cm	8 mm	-	12 mm	1/36
030 745	40 cm	8 mm	-	12 mm	1/12

## motive

Jakość ma znaczenie



### WAŁEK MALARSKI V-PRO WHITE FIBRA



## motive

Jakość ma znaczenie



### WAŁEK MALARSKI V-PRO FIBRA



## motive

Jakość ma znaczenie

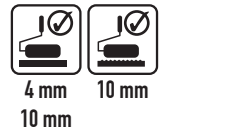

### WAŁEK MALARSKI V-PRO MOHAIR



## motive

Jakość ma znaczenie



### WAŁEK MALARSKI V-PRO NYLON



## motive

Jakość ma znaczenie



### WAŁEK MALARSKI V-PRO PES





**POLYACRYL**



**WKŁAD GIRPAINT (2 SZT.)**

2 x Mini GIRPAINT roller refill • 2 x Минивалик "GIRPAINT" • 2 x Ролка GIRPAINT  
• 2 x Kleinflächenwalze Girpaint • 2 x Rola Girpaint

NUMER KATALOGOWY					
030 101	7 cm	15 mm	11 mm	6 mm	1/5/250
030 102	10 cm	15 mm	11 mm	6 mm	1/5/250
030 103	15 cm	15 mm	11 mm	6 mm	1/5/250



**POLYACRYL**



**WKŁAD MIDI GIRPAINT (2 SZT.)**

2 x Midi GIRPAINT roller refill • 2 x Минивалик "MIDI GIRPAINT"  
• 2 x Kleinflächenwalze Midi Girpaint • 2 x Rola Girpaint Midi

NUMER KATALOGOWY					
030 131	10 cm	30 mm	11 mm	6 mm	5/250
030 132	15 cm	30 mm	11 mm	6 mm	5/250



**POLYACRYL**



**WAŁEK GIRPAINT**

GIRPAINT roller refill • Валик "GIRPAINT" запас  
• Malerwalze Girpaint • Rola Girpaint

NUMER KATALOGOWY					
030 010	18 cm	48 mm	11 mm	8 mm	70/1400
030 011	25 cm	48 mm	11 mm	8 mm	70/1050



**POLYACRYL**



**ROLKA GIRPAINT**

GIRPAINT roller complete with frame • Валик "GIRPAINT" + ручка  
• Farbroller Girpaint • Rola Girpaint

NUMER KATALOGOWY					
030 170	18 cm	48 mm	11 mm	8 mm	1/60
030 171	25 cm	48 mm	11 mm	8 mm	1/60



**POLYACRYL**



**WKŁAD MULTIKOLOR (2 SZT.)**

2 x MULTIKOLOR roller refill • 2 x Минивалик "MULTIKOLOR"  
• 2 x Kleinflächenwalze Multikolor • 2 x Rola Multikolor

NUMER KATALOGOWY					
030 265	7 cm	15 mm	11 mm	6 mm	5/250
030 266	10 cm	15 mm	11 mm	6 mm	5/250
030 267	15 cm	15 mm	11 mm	6 mm	5/250



**POLYACRYL**



**WKŁAD MIDI MULTIKOLOR (2 SZT.)**

2 x Midi MULTIKOLOR roller refill • 2 x Минивалик "MIDI MULTIKOLOR"  
• 2 x Kleinflächenwalze Midi Multikolor • 2 x Rola Multikolor Midi

NUMER KATALOGOWY					
030 133	10 cm	30 mm	11 mm	6 mm	5/250
030 134	15 cm	30 mm	11 mm	6 mm	5/250



### WAŁEK MULTIKOLOR

MULTIKOLOR roller refill • Валик "MULTICOLOR" запас • Malerwalze Multikolor  
 • Rola Multikolor

NUMER KATALOGOWY					
030 027	18 cm	48 mm	16 mm	8 mm	70/1400
030 028	25 cm	48 mm	16 mm	8 mm	70/1050



### ROLKA MULTIKOLOR

MULTIKOLOR roller complete with frame • Валик "MULTIKOLOR" + ручка  
 • Multikolor Roller • Rola Multikolor

NUMER KATALOGOWY					
030 179	18 cm	48 mm	16 mm	8 mm	1/60
030 180	25 cm	48 mm	16 mm	8 mm	1/30



### WAŁEK MULTIKOLOR FASADOWY

MULTIKOLOR roller refill + foam • Валик фасадный "MULTICOLOR" запас  
 • Fassadenwalze Multicolor • Rola de fatada Multikolor

NUMER KATALOGOWY						
030 020	18 cm	48 mm	16 mm	6 mm	8 mm	70/1050
030 021	25 cm	48 mm	16 mm	6 mm	8 mm	70/840



### ROLKA MULTIKOLOR FASADOWY

MULTIKOLOR roller complete with frame + foam • Валик фасадный "MULTIKOLOR" + ручка  
 • Multikolor Fassadenroller • Rola de fatada Multikolor

NUMER KATALOGOWY						
030 175	18 cm	48 mm	16 mm	6 mm	8 mm	1/30
030 176	25 cm	48 mm	16 mm	6 mm	8 mm	1/30



### WAŁEK ELITAKOLOR FASADOWY

ELITAKOLOR roller refill + foam • Валик фасадный "ELITAKOLOR" запас  
 • Fassaden-Malerwalze Elitakolor • Rola de fatada Elitakolor

NUMER KATALOGOWY						
030 018	18 cm	48 mm	16 mm	8 mm	8 mm	70/1050
030 019	25 cm	48 mm	16 mm	8 mm	8 mm	70/840



### ROLKA ELITAKOLOR FASADOWY

ELITAKOLOR roller complete with frame + foam • Валик фасадный "ELITAKOLOR" + ручка  
 • Elitakolor Fassadenroller • Rola de fatada Elitakolor

NUMER KATALOGOWY						
030 173	18 cm	48 mm	16 mm	8 mm	8 mm	1/30
030 174	25 cm	48 mm	16 mm	8 mm	8 mm	1/30





**POLYACRYL**



**WKŁAD SYNTEX (2 SZT.)**

2 x Mini SYNTEX roller refill • 2 x Минивалик "SYNTEX"  
• 2 x Kleinflächenwalze Syntex • 2 x Rola Syntex

NUMER KATALOGOWY					
030 128	7 cm	15 mm	11 mm	6 mm	5/250
030 129	10 cm	15 mm	11 mm	6 mm	5/250
030 130	15 cm	15 mm	11 mm	6 mm	5/250



**POLYACRYL**



**WKŁAD MIDI SYNTEX (2 SZT.)**

2 x Midi SYNTEX roller refill • 2 x Минивалик "MIDI SYNTEX"  
• 2 x Kleinflächenwalze Midi Syntex • 2 x Rola Syntex Midi

NUMER KATALOGOWY					
030 137	10 cm	30 mm	11 mm	6 mm	5/250
030 138	15 cm	30 mm	11 mm	6 mm	5/250



**POLYACRYL**



**WĄLEK SYNTEX**

SYNTEX roller refill • Валик "SYNTEX" запас • Malerwalze Syntex • Rola Syntex

NUMER KATALOGOWY					
030 035	18 cm	48 mm	12 mm	8 mm	70/1400
030 036	25 cm	48 mm	12 mm	8 mm	70/1050



**POLYACRYL**



**ROLKA SYNTEX**

SYNTEX roller complete with frame • Валик "SYNTEX" + ручка  
• Farbroller Syntex • Rola Syntex

NUMER KATALOGOWY					
030 040	18 cm	48 mm	12 mm	6 mm	1/60
030 041	23 cm	48 mm	12 mm	6 mm	1/60



**POLYACRYL**



**WĄLEK SYNTEX FASADOWY**

SYNTEX roller refill + foam • Валик фасадный "SYNTEX" запас  
• Fassadenwalze Syntex • Rola de fatada Syntex

NUMER KATALOGOWY						
030 037	18 cm	48 mm	16 mm	6 mm	8 mm	70/1050
030 038	25 cm	48 mm	16 mm	6 mm	8 mm	70/840





### ROLKA SYNTEX FASADOWY

SYNTEX roller complete with frame + foam • Валик фасадный "SYNTEX" + ручка • Syntex Fassadenroller • Rola de fatada Syntex

NUMER KATALOGOWY						
030 183	18 cm	48 mm	16 mm	6 mm	8 mm	1/30
030 184	25 cm	48 mm	16 mm	6 mm	8 mm	1/30

### WALEK ORANGE

ORANGE roller refill • Валик "ORANGE" запас • Malerwalze Orange • Rola Orange

NUMER KATALOGOWY					
030 032	18 cm	48 mm	10 mm	8 mm	1/10/70
030 033	25 cm	48 mm	10 mm	8 mm	1/10/70

### ROLKA ORANGE

ORANGE roller complete with frame • Валик "ORANGE" + ручка • Orange Roller • Rola Orange

NUMER KATALOGOWY					
030 186	18 cm	48 mm	10 mm	8 mm	1/60
030 187	25 cm	48 mm	10 mm	8 mm	1/30

### ROLKA WESTAN

WESTAN roller complete with frame • Валик "WESTAN" + ручка • Vestan Roller • Rola Westan

NUMER KATALOGOWY					
030 227	18 cm	48 mm	15 mm	6 mm	1/60
030 228	23 cm	48 mm	15 mm	6 mm	1/60

### ROLKA DULUX

DULUX roller complete with frame • Валик "DULUX" + ручка • Farbroller Dulux • Rola Dulux

NUMER KATALOGOWY					
030 039	25 cm	58 mm	8 mm	8 mm	1/40

POLYACRYL



POLYACRYL



POLYACRYL



POLYESTER





**POLYESTER**



**WAŁEK OWCZA WEŁNA**

SHEEP WOOL roller refill • Валик "ОВЕЧЬЯ ШЕРСТЬ" запас • Ролка ОВЧА ВЪЛНА  
• Volelis "avies kailis" • Malerwalze Lammfell- Synthetik

NUMER KATALOGOWY					
030 030	18 cm	48 mm	16 mm	8 mm	1/10/70
030 031	25 cm	48 mm	16 mm	8 mm	1/10/70



**SHEEP WOOL**



**ROLKA ROLLEX THICK**

Rollex roller (sheepskin) • Валик, овечья шерсть "Rollex" + ручка  
• Lammfellwalze Rollex • Rola Rollex Thick

NUMER KATALOGOWY					
030 160	18 cm	50 mm	18 mm	7 mm	1/60
030 161	24 cm	50 mm	18 mm	7 mm	1/60



**MICROFIBER**



**WKŁAD MIKROFAZA (2 SZT.)**

2 x Mini MIKROFAZA roller refill • 2 x Минивалик "МИКРОФАЗА"  
• 2 x Kleinflächenwalze Microfaser • 2 x Rola Mikrofaza

NUMER KATALOGOWY					
030 141	7 cm	15 mm	10 mm	6 mm	5/250
030 142	10 cm	15 mm	10 mm	6 mm	5/250



**MICROFIBER**



**WAŁEK MIKROFAZA**

MIKROFAZA roller refill • Валик "МИКРОФАЗА" запас • Malerwalze Microfaser  
• Rola Mikrofaza

NUMER KATALOGOWY					
030 016	18 cm	48 mm	10 mm	8 mm	1/10/70
030 017	25 cm	48 mm	10 mm	8 mm	1/10/70



**MICROFIBER**



**ROLKA MIKROFAZA**

MIKROFAZA roller complete with frame • Валик "МИКРОФАЗА" + ручка  
• Microfaser Roller • Rola Mikrofaza

NUMER KATALOGOWY					
030 190	18 cm	48 mm	10 mm	8 mm	1/60
030 191	25 cm	48 mm	10 mm	8 mm	1/60



### ZAPAS MOLTOFLOK

FLOCK roller refill • Минивалик "MOLTOFLOK" (акрил)  
• Flock-Walze • Rola Moltoflok

NUMER KATALOGOWY				
030 530	5 cm	35 mm	6 mm	10/1160
030 531	7 cm	35 mm	6 mm	10/820
030 532	10 cm	35 mm	6 mm	10/560
030 533	15 cm	35 mm	6 mm	10/420



### ZAPAS MOLTOFLOK MIDI

FLOCK roller refill MIDI • Минивалик "MOLTOFLOK MIDI" (акрил)  
• Flock-Walze Midi • Rola Moltoflok

NUMER KATALOGOWY				
030 535	18 cm	50 mm	6 mm	5/185



### ZAPAS MOLTOFLOK (2 SZT.)

2 x FLOCK roller refill • 2 x Минивалик "MOLTOFLOK" (акрил) • 2 x Flock-Walze  
• 2 x Rola Moltoflok

NUMER KATALOGOWY				
030 536	5 cm	35 mm	6 mm	1/500
030 537	7 cm	35 mm	6 mm	1/448
030 538	10 cm	35 mm	6 mm	1/320
030 539	15 cm	35 mm	6 mm	1/220



### ZAPAS MOLTOFLOK NIEBIESKI (2 SZT.)

2 x Blue flock roller refill • 2 x Минивалик "MOLTOFLOK" (синий)  
• 2 x Flock-Walze, blau • Rola Moltoflok albastru

NUMER KATALOGOWY				
030 540	10 cm	35 mm	6 mm	1/320



### WKŁAD MIDI NYLON (2 SZT.)

2 x Midi NYLON roller refill • 2 x Минивалик "MIDI NYLON"  
• 2 x Kleinflächenwalze Midi Nylon • 2 x Rola Nylon

NUMER KATALOGOWY					
030 135	10 cm	30 mm	9 mm	6 mm	5/250
030 136	15 cm	30 mm	9 mm	6 mm	5/250





**NYLON**



**WĄLEK NYLON (CZERWONY PASEK)**

NYLON roller refill (red stripe) • Валик "NYLON" запас (красная полоска)  
• Malerwalze Nylon, rot Streifen • Rola Nylon

NUMER KATALOGOWY					
030 025	18 cm	48 mm	12 mm	8 mm	70/1400
030 026	25 cm	48 mm	12 mm	8 mm	70/1050

**NYLON**



**ROLKA NYLON**

NYLON roller complete with frame • Валик "NYLON" + ручка  
• Nylon Roller • Rola Nylon

NUMER KATALOGOWY					
030 177	18 cm	48 mm	12 mm	8 mm	1/60
030 178	25 cm	48 mm	12 mm	8 mm	1/60



**MOLTOPREN**

Foam roller refill • Минивалик "MOLTOPREN" • Schaumwalze • Rola Moltopren

NUMER KATALOGOWY				
030 111	5 cm	35 mm	6 mm	10/1600
030 112	7 cm	35 mm	6 mm	10/1100
030 113	10 cm	35 mm	6 mm	10/840
030 114	15 cm	35 mm	6 mm	10/500



**MOLTOPREN MIDI**

FOAM roller refill • Минивалик "MOLTOPREN" • Schaumwalze Midi  
• Rola Moltopren Midi

NUMER KATALOGOWY				
030 115	15 cm	50 mm	6 mm	10/150



**MOLTOPREN (2 SZT.)**

2 x FOAM roller refill • 2 x Минивалик "MOLTOPREN" • 2 x Schaumwalze  
• 2 x Rola Moltopren

NUMER KATALOGOWY				
030 116	5 cm	35 mm	6 mm	1/500
030 117	7 cm	35 mm	6 mm	1/532
030 118	10 cm	35 mm	6 mm	1/380
030 119	15 cm	35 mm	6 mm	1/250



### ROLKA MOLTOPREN

Foam roller MOLTOPREN complete with frame • Валик "MOLTOPREN" + ручка  
 • Schaum Roller • Rola Moltopren

NUMER KATALOGOWY				
030 220	25 cm	80 mm	6 mm	1/50



### ROLKA DO SIATKI

Grid roller • Валик для сетки + ручка • Schaum Roller zum Streichen von Gitter  
 • Trafalet pentru plasă

NUMER KATALOGOWY				
030 052	18 cm	50 mm	6 mm	1/125



### WKŁAD VELUR (2 SZT.)

2 x Mini VELUR roller refill • 2 x Минивалик "VELUR"  
 • 2 x Kleinflächenwalze Velour • 2 x Rola Velur

NUMER KATALOGOWY				
030 125	7 cm	15 mm	4 mm	1/5/250
030 126	10 cm	15 mm	4 mm	1/5/250
030 127	15 cm	15 mm	4 mm	1/5/250



### WKŁAD MIDI VELUR (2 SZT.)

2 x Midi VELUR roller refill • 2 x Минивалик "MIDI VELUR"  
 • 2 x Kleinflächenwalze Midi Velour • 2 x Rola Velur Midi

NUMER KATALOGOWY				
030 139	10 cm	30 mm	4 mm	5/250
030 140	15 cm	30 mm	4 mm	5/250



### WAŁEK VELUR

VELUR roller refill • Валик "VELUR" запас • Malerwalze Velur • Rola Velur

NUMER KATALOGOWY				
030 282	18 cm	40 mm	4 mm	1/60/2700
030 283	25 cm	40 mm	4 mm	1/60/2400





**VELUR**



**ROLKA VELUR**

VELUR roller complete with frame • Валик "VELUR" + ручка  
• Velour Roller • Rola Velur

NUMER KATALOGOWY					
030 215	15 cm	40 mm	4 mm	6 mm	1/60
030 216	25 cm	40 mm	4 mm	6 mm	1/60



**KOMPLET MALARSKI**

Foam roller set with handle • Комплект малярный • Lackier-Set • Set trafalet

NUMER KATALOGOWY			
030 120	6 cm	30 mm	1/70
030 121	8 cm	30 mm	1/50



**KOMPLET MALARSKI NITRO**

Flock roller set with handle • Комплект малярный "NITRO"  
• Nitro-Set • Set trafalet Nitro

NUMER KATALOGOWY			
030 122	6 cm	30 mm	1/70
030 123	8 cm	30 mm	1/50



**WOOSTER®**



**WKŁAD JUMBOKOTER PRO/DOO-Z FTP (2 SZT.)**

2 x PRO/DOO-Z FTP • 2 x Минивалик PRO/DOO-Z FTP  
• 2 x Kleinflächenwalze PRO/DOO-Z FTP • Rola PRO/DOO-Z FTP

NUMER KATALOGOWY			
RR 382	4,5" (11,5 cm)	12 mm	1/12



**WOOSTER®**



**WKŁAD PRO/DOO-Z (2 SZT.)**

2 x Jumbo-Koter Pro/Doo-Z® • 2 x Минивалик "PRO/DOOZ-Z"  
• 2 x Kleinflächenwalze PRO/DOO-Z • Rola PRO/DOO-Z

NUMER KATALOGOWY			
RR302 4 1/2	4,5" (11,5 cm)	9 mm	1/12
RR302 6 1/2	6,5" (16,5 cm)	9 mm	1/6



### WAŁEK PRO DOO-Z

Pro Doo-z roller refill • Валик PRO DOO-Z запас • Malerwalze PRO/DOO-Z  
• Rola PRO/DOO-Z

NUMER KATALOGOWY			
RR641 9	9" (23 cm)	5 mm	1/12
RR642 9	9" (23 cm)	9 mm	1/12
RR643 9	9" (23 cm)	12 mm	1/12
RR644 9	9" (23 cm)	18 mm	1/12
RR641 18	18" (46 cm)	5 mm	1/6
RR642 18	18" (46 cm)	9 mm	1/6
RR643 18	18" (46 cm)	12 mm	1/6

### WAŁEK LAMBSWOOL

LAMBSWOOL roller refill • Валик LAMBSWOOL запас  
• Farbwalze Natur-Lammfell • Rola LAMBSWOOL

NUMER KATALOGOWY			
R291 9	9" (23 cm)	12 mm	1/24

### WAŁEK SUPER FAB

Super Fab roller refill • Валик Super Fab • Malerwalze SUPER FAB  
• Rola SUPER FAB

NUMER KATALOGOWY			
R239 9	9" (23 cm)	9 mm	1/12
R240 9	9" (23 cm)	12 mm	1/12
R241 9	9" (23 cm)	18 mm	1/12
R240 18	18" (46 cm)	12 mm	1/12

### WAŁEK AMERICAN CONTRACTOR

American contractor roller refill • Валик American contractor запас  
• Farbwalze American contractor • Rola American contractor

NUMER KATALOGOWY			
R363	18" (46 cm)	13 mm	1/24

### WAŁEK MOHAIR BLEND

MOHAIR BLEND roller refill • Валик MOHAIR BLEND  
• Malerwalze MOHAIR BLEND • Rola MOHAIR BLEND

NUMER KATALOGOWY			
R207 9	9" (23 cm)	6 mm	1/12
R207 18	18" (46 cm)	6 mm	1/12

## WOOSTER®



5 mm 12 mm 18 mm  
9 mm



## WOOSTER®



SHEEP WOOL



## WOOSTER®



9 mm 12 mm 18 mm



## WOOSTER®



## WOOSTER®



MOHAIR





**WOOSTER®**

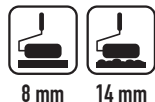

8 mm 14 mm



**WAŁEK MICRO PLUSH**

MICRO PLUSH roller refill • Валик MICRO PLUSH • Malerwalze MICRO PLUSH  
• Rola MICRO PLUSH

NUMER KATALOGOWY			
R235 9	9" (23 cm)	8 mm	1/12
R235 18	18" (46 cm)	8 mm	1/12
R524 18	18" (46 cm)	14 mm	1/12
R524 9	9" (23 cm)	14 mm	1/12

**WOOSTER®**



MICROFIBER



**WKŁAD MICROFIBRA (2 SZT.)**

2 x MICROFIBRA roller refill • 2 x Минивалик MICROFIBRA  
• 2 x Kleinflächenwalze Micorfaser • Rola MICROFIBRA

NUMER KATALOGOWY			
RR314 4 1/2	4,5" (11,5 cm)	10 mm	1/12

**UCHWYT**

Roller frame • Рукоятка-бюгель для миниваликов • Farbrollenbügel  
• Maner pentru trafalet

NUMER KATALOGOWY				
030 401	5-7 cm	19 cm	6 mm	1/50
030 402	10-15 cm	27 cm	6 mm	1/50
030 403	10-15 cm	39 cm	6 mm	1/100

**UCHWYT**

Roller frame • Рукоятка-бюгель для валиков • Farbrollenbügel  
• Maner pentru trafalet

NUMER KATALOGOWY				
030 410	18 cm	28 cm	8 mm	1/100/3400
030 411	25 cm	31 cm	8 mm	1/100/3400

**UCHWYT DO ZAPASÓW**

Roller frame • Рукоятка-бюгель для валиков • Farbrollenbügel  
• Maner pentru trafalet

NUMER KATALOGOWY				
030 404	15-18 cm	25,5 cm	6 mm	1/100
030 405	25 cm	28 cm	6 mm	1/100





# UCHWYT KOSZYKOWY **V-PRO** CAGE ROLLER HANDLE

- Wysokiej jakości uniwersalny uchwyt koszykowy do wałków
- Ergonomiczna i wygodna w użyciu rączka
- Gwint na końcu rączki pasujący do większości kijów teleskopowych



## UCHWYT KOSZYKOWY

Cage roller handle • Ручка каркасная • Korbbugel • Maner pentru trafalet V-Pro

NUMER KATALOGOWY			
030 390	19 mm	10 cm	1/50
030 409	38 mm	23 cm	1/20



**SPRAWDŹ OFERTĘ  
 WAŁKÓW KOSZYKOWYCH**  
 (str. 61)



ALU



## UCHWYT KOSZYKOWY ALUMINIOWY

Cage roller handle • Ручка каркасная • Korbbugel • Maner pentru trafalet

NUMER KATALOGOWY			
030 389	38 mm	23 cm	1/24





**WSZYSTKIE UCHWYTY SOFT I KOSZYKOWE Z NASZEJ OFERTY  
WYPOSAŻONE SĄ W GWINT MOCUJĄCY**

Pasują do kijów teleskopowych z końcówką  
z gwintem amerykańskim (patrz: katalog str. 86-87)

**V-PRO**



**UCHWYT DO WAŁKÓW V-PRO**

Roller frame • Рукьятка-бюгель для валиков • Farbrollenbügel  
• Maner pentru trafalet

NUMER KATALOGOWY				
030 393	23 cm	8 mm	1/30	



**UCHWYT SOFT**

Soft handle roller frame • Рукьятка-бюгель для валиков "SOFT"  
• Farbrollenbügel Soft • Maner pentru trafalet

NUMER KATALOGOWY				
030 408	5-7 cm	19 cm	6 mm	1/50
030 407	10-15 cm	27 cm	6 mm	1/50
030 406	10-15 cm	39 cm	6 mm	1/50



**UCHWYT SOFT**

Soft handle roller frame • Рукьятка-бюгель для валиков "SOFT"  
• Farbrollenbügel Soft • Maner pentru trafalet

NUMER KATALOGOWY				
030 251	18 cm	33 cm	8 mm	1/50
030 252	25 cm	33,5 cm	8 mm	1/50

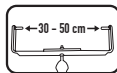

**UCHWYT DO WAŁKÓW REGULOWANY**

Roller frame • Рукьятка-бюгель для валиков • Rollerbügel für Bodenwalzen  
• Maner pentru trafalet

NUMER KATALOGOWY			
030 413	30-50 cm	8 mm	1/30

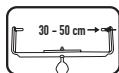

**UCHWYT DO WAŁKÓW REGULOWANY**

Roller frame • Рукьятка-бюгель для валиков • Rollerbügel für Bodenwalzen  
• Maner pentru trafalet

NUMER KATALOGOWY			
030 414	30-50 cm	8 mm	1/30



#### UCHWYT SHERGRIP

Roller frame Shergrip • Ручьятка Shergrip • Shergrip Korbbugel  
 • Maner pentru trafalet Sher Grip

NUMER  
KATALOGOWY



R501

9" (23 cm)

1/12

#### UCHWYT DO WAŁKÓW ACME

Acme™ Heavy-Duty Roller Frame • Ручьятка-бюгель Acme™ Heavy-Duty Roller  
 • Roller Korbbugel Acme • Maner pentru trafalet Acme

NUMER  
KATALOGOWY



F0010-9

9" (23 cm)

1/24

#### UCHWYT BIG BEN

Big Ben Roller Frame • Ручьятка-бюгель Big Ben • Farbrollerbügel

NUMER  
KATALOGOWY



BR045 18

18" (46 cm)

1/10

#### UCHWYT DO WAŁKÓW HULK

Sherlock Wide Boy™ Hulk™ • Ручьятка-бюгель Sherlock Wide Boy™ Hulk™  
 • Farbrollen Bügel Hulk™ • Maner pentru trafalet Sherlock Wide Boy™ Hulk™

NUMER  
KATALOGOWY



BR047-18

12-18" (31-46 cm)

1/3

#### UCHWYT DO WKŁADÓW

Jumbo-Koter® Frame • Ручьятка-бюгель Jumbo-Koter • Korbbugel für Wooster  
 • Maner pentru trafalet Jumbo-Koter

NUMER  
KATALOGOWY



RR013

19 mm

12" (31 cm)

1/12

**WOOSTER®**  
 KOMPATYBILNE Z  
**V-PRO**  
 COMPATIBLE



**WOOSTER®**  
 KOMPATYBILNE Z  
**V-PRO**  
 COMPATIBLE



**WOOSTER®**



**WOOSTER®**



**WOOSTER®**  
 KOMPATYBILNE Z  
**V-PRO**  
 COMPATIBLE





**WOOSTER®**

KOMPATYBILNE Z  
**V-PRO**  
COMPATIBLE



**UCHWYT JUMBO - KOTER FLIP FRAME**

Jumbo Koter Flip Frame • Ручьятка Jumbo Koter Flip Frame  
• Korbbügel Jumbo Koter Flip Frame • Maner pentru trafalet Jumbo Koter Flip Frame

NUMER  
KATALOGOWY



19 mm



4,5" (11,5 cm)



1/12



**WOOSTER®**

KOMPATYBILNE Z  
**V-PRO**  
COMPATIBLE



**UCHWYT JUMBO KOTER SHERGRIP**

Jumbo Koter Shergrip • Ручьятка Jumbo Koter Shergrip • Korbbügel JUMBO-KOTER SHERGRIP • Maner pentru trafalet Jumbo Koter Shergrip

NUMER  
KATALOGOWY



19 mm



4,5" (11,5 cm)



1/12



**WOOSTER®**

KOMPATYBILNE Z  
**V-PRO**  
COMPATIBLE

**UCHWYT DO WAŁKÓW SHERLOCK**

Sherlock® Roller Frame • Ручьятка-бюгель Sherlock® • Korbbügel Sherlock®  
• Maner pentru trafalet Sherlock

NUMER  
KATALOGOWY



38 mm



9" (23 cm)



1/6



**motive**  
Jakość ma znaczenie

**POLYAMIDE**

**ROLKA DO NAROŻNIKÓW**

Corner roller • Валик для покраски углов + ручка • Eckenroller  
• Trafalet pentru colt

NUMER  
KATALOGOWY



5 cm



15 mm



6 mm



1/10



**POLYACRYL**

**ROLKA DO NAROŻNIKÓW**

Corner roller • Валик для покраски углов + ручка • Eckenroller  
• Trafalet pentru colt

NUMER  
KATALOGOWY



5 cm



50 mm



6 mm



1/100



#### ROLKA DO PASKÓW

Edging paint roller • Валик для полос + ручка • Beschneiderroller  
• Trafalet cu distantier

NUMER  
KATALOGOWY

030 213



10 mm



10 cm



1/10

#### ZAPAS DO ROLKI DO PASKÓW

Motive roller refill • Валик для полос запас • Ersatzwalze für Wandkantenroller  
• Rezerva pentru trafalet cu distantier

NUMER  
KATALOGOWY

030 214



10 mm



10 cm



1/10

#### OSŁONA ROLKI DO PASKÓW

Cover plate for Motive roller • Защитный элемент для валика для полос  
• Abdeckplatte für Wandkantenroller • Capac pentru trafalet cu distantier

NUMER  
KATALOGOWY

030 219



1/10

#### ROLKA DO PASKÓW

Edging paint roller • Валик для полос + ручка • Beschneiderroller  
• Trafalet cu distantier

NUMER  
KATALOGOWY

030 222



10 mm



10 cm



1/20

#### ZAPAS DO ROLKI DO PASKÓW

Roller refill • Валик для полос запас • Ersatzwalze für Wandkantenroller  
• Rezerva pentru trafalet cu distantier

NUMER  
KATALOGOWY

030 223



10 mm



10 cm



1/200

**motive**  
Jakość ma znaczenie

POLYAMIDE

BLISTER



**motive**  
Jakość ma znaczenie

POLYAMIDE

BLISTER



**motive**  
Jakość ma znaczenie

BLISTER



MICROFIBER

BLISTER



MICROFIBER





**motive**  
Jakość ma znaczenie

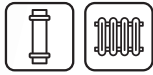

**ROLKA DO RUR**

Tube painting roller • Валик для покраски труб + ручка • Rohrroller  
• Trafalet pentru tevi

NUMER KATALOGOWY				
030 212	3 x 20 mm	12 mm	6 mm	1/10

**ZAPAS DO ROLKI DO RUR - 3 SZT.**

Tube roller refill • Ersatzwalzen für Rohrroller

030 209	3 x 20 mm	12 mm	6 mm	1/500
---------	-----------	-------	------	-------



**motive**  
Jakość ma znaczenie



**WAŁEK DO GŁADZI**

Skim coat roller • Гипсовый валик • Spachtel Rolle • Trafalet glet

NUMER KATALOGOWY				
030 193	9 cm	18 mm	8 mm	1/60
030 196	23 cm	18 mm	8 mm	1/30



**WAŁEK DO GŁADZI**

Skim coat roller • Гипсовый валик • Spachtel Rolle • Trafalet glet

NUMER KATALOGOWY				
030 195	8 cm	18 mm	8 mm	1/60
030 197	22 cm	18 mm	8 mm	1/30



**motive**  
Jakość ma znaczenie



**ROLKA DO GŁADZI**

Skim coat roller • Spachtel Rolle • Trafalet glet

NUMER KATALOGOWY				
030 203	90 mm	18 mm	8 mm	1/100
030 204	230 mm	18 mm	8 mm	1/30



**ROLKA DO GŁADZI**

Skim coat roller • Spachtel Rolle • Trafalet glet

NUMER KATALOGOWY					
030 198	80 mm	18 mm	8 mm	1/100	
030 200	220 mm	18 mm	8 mm	1/30	
030 199	narożna/corner	40 mm	18 mm	8 mm	1/30



**ZESTAW MALARSKI 2 x WHITE FIBRA KOSZYKOWY**

Painting set White Fibra • Набор малярный White Fibra • Emulsion-Set White Fibra • Set trafalet White Fibra

NUMER  
KATALOGOWY

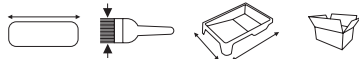

030 565      23 cm      2"      34 x 38 cm      1/10

**ZESTAW MALARSKI 2 x WHITE FIBRA**

Painting set White Fibra • Набор малярный White Fibra • Emulsion-Set White Fibra • Set trafalet White Fibra

NUMER  
KATALOGOWY

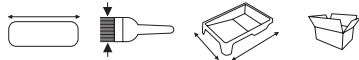

030 566      23 cm      2"      16 x 28 cm      1/10

**ZESTAW MALARSKI WHITE FIBRA 40 cm**

Painting set White Fibra • Набор малярный White Fibra • Emulsion-Set White Fibra • Set trafalet White Fibra

NUMER  
KATALOGOWY



030 567      40 cm/10 cm      54 x 38 cm      1/10

**ZESTAW MALARSKI DO EMULSJI NR 30**

Painting set for emulsion paints item no. 30 • Набор малярный для эмульсий № 30 • Emulsion-Set Nr 30 • Set trafalet 30

NUMER  
KATALOGOWY

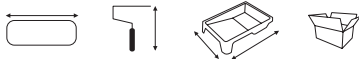

030 430      10 cm      27 cm      16 x 28 cm      1/10

**ZESTAW MALARSKI DO EMULSJI NR 31**

Painting set for emulsion paints item no. 31 • Набор малярный для эмульсий № 31 • Emulsion-Set Nr 31 • Set trafalet 31

NUMER  
KATALOGOWY

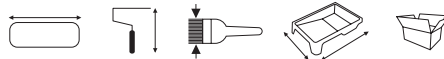

030 431      10 cm      27 cm      1,5"      16 x 28 cm      1/10

**motive**  
Jakość ma znaczenie

MICROFIBER



**motive**  
Jakość ma znaczenie

MICROFIBER



**motive**  
Jakość ma znaczenie

MICROFIBER



POLYACRYL







POLYACRYL





**ZESTAW MALARSKI DO BEJC NR 15**





Painting set for wood stains item no. 15 • Набор малярный для морилок № 15  
• Beize - Set Nr 15 • Set trafalet 15

NUMER KATALOGOWY					
030 415	10 cm	27 cm	43 mm	16 x 28 cm	1/10



**ZESTAW MALARSKI DO LAKIERÓW NR 16**





Painting set for varnishes item no. 16 • Набор малярный для лаков № 16  
• Lacke - Set Nr 16 • Set trafalet 16

NUMER KATALOGOWY					
030 416	10 cm	27 cm	43 mm	16 x 28 cm	1/10



**ZESTAW MALARSKI DO FARB FTALOWYCH NR 7**





Painting set for solvent-based paints item no. 7 • Набор малярный для алкидных красок № 7 • Lackier-Set Nr 7 • Set trafalet 7

NUMER KATALOGOWY				
030 107	10 cm	27 cm	16 x 28 cm	1/10



**ZESTAW MALARSKI DO FARB FTALOWYCH NR 4**





Painting set for solvent-based paints item no. 4 • Набор малярный для алкидных красок № 4 • Alkyd-Set Nr 4 • Set trafalet 4

NUMER KATALOGOWY					
030 104	10 cm	27 cm	1,5"	16 x 28 cm	1/10



**ZESTAW MALARSKI DO FARB WODOROZCIEŃCZALNYCH NR 22**

Painting set for water-based paints item no. 22 • Набор малярный для красок на водной основе № 22 • Lasuren-Set Nr 22 • Set trafalet 22

NUMER KATALOGOWY				
030 522	10 cm	27 cm	16 x 28 cm	1/10





**ZESTAW MALARSKI DO FARB WODOROZCIEŃCZALNYCH NR 23**

Painting set for water-based paints item no. 23 • Набор малярный для красок на водной основе № 23 • Lasuren-Set Nr 23 • Set trafalet 23

NUMER KATALOGOWY					
030 523	10 cm	27 cm	1,5"	16 x 28 cm	1/10



**ZESTAW MALARSKI DO FARB WODOROZCIEŃCZALNYCH NR 24**

Painting set for water-based paints item no. 24 • Набор малярный для красок на водной основе № 24 • Lasuren-Set Nr 24 • Set trafalet 24

NUMER KATALOGOWY					
030 524	10 cm	27 cm	1,5"	16 x 28 cm	1/10



**ZESTAW MALARSKI DO FARB WODOROZCIEŃCZALNYCH NR 25**

Painting set for water-based paints item no. 25 • Набор малярный для красок на водной основе № 25 • Lasuren-Set Nr 25 • Set trafalet 25

NUMER KATALOGOWY					
030 525	10 cm	27 cm	1,5"	16 x 28 cm	1/10



**ZESTAW MOLTOFLOK Z KUWETA**

Flock roller set with paint tray • Комплект "MOLTOFLOK" + кювета • Lasuren-Set, Flock-Walze in Wanne • Set trafalet Moltoflok cu tava

NUMER KATALOGOWY					
030 520	5 cm	PP	12 x 20 cm	1/50	
030 521	7 cm	PP	12 x 20 cm	1/50	



**ZESTAW MOLTOPREN Z KUWETA**

Foam roller set with paint tray • Комплект "MOLTOPREN" + кювета • Lackier-Set, Schaumroller in Wanne • Set trafalet Moltopren cu tava

NUMER KATALOGOWY					
030 105	5 cm	PP	12 x 20 cm	1/50	
030 106	7 cm	PP	12 x 20 cm	1/50	





### ZESTAW MOLTOPREN Z KUWETA

Foam roller set with paint tray • Комплект "MOLTOPREN" + кювета  
• Lackier-Set, Schaumroller in Wanne • Set trafalet Moltopren cu tava

NUMER KATALOGOWY				
030 108	5 cm	19 cm Ø 6 mm	12 x 20 cm	1/50
030 109	7 cm	19 cm Ø 6 mm	12 x 20 cm	1/50
030 110	15 cm	24 cm Ø 6 mm	12 x 20 cm	1/50



### ZESTAW MOLTOFLOK Z KUWETA

Foam roller set with paint tray • Комплект "MOLTOFLOK" + кювета  
• Lackier-Set, Schaumroller in Wanne • Set trafalet Moltoflok cu tava

NUMER KATALOGOWY				
030 541	5 cm	PP	12 x 20 cm	1/50
030 542	7 cm	PP	12 x 20 cm	1/50



### POLYACRYL

### ZESTAW MALARSKI MULTIKOLOR

Painting set • Набор малярный • Maler Set • Set trafalet

NUMER KATALOGOWY					
030 432	38 mm/50 m	25 cm	25 cm Ø 6 mm	32 x 34 cm	1/10



### POLYACRYL

### ZESTAW MALARSKI SYNTAX

Painting set • Набор малярный • Maler Set • Set trafalet

NUMER KATALOGOWY					
030 433	48 mm/25 m	18 cm	18 cm Ø 8 mm	24 x 26 cm	1/10



### MICROFIBER

### ZESTAW MIKROFAZA NR 3





Painting set • Набор малярный • Maler Set • Set trafalet

NUMER KATALOGOWY					
030 438	48 mm/25 m	18 cm	18 cm Ø 8 mm	24 x 26 cm	1/10
030 437	48 mm/50 m	25 cm	25 cm Ø 8 mm	32 x 34 cm	1



### ZESTAW MALARSKI GIRPAINT

Painting set • Набор малярный • Maler Set • Set trafalet





NUMER KATALOGOWY				
030 434	18 cm	18 cm Ø 8 mm	24 x 26 cm	1/15
030 435	25 cm	25 cm Ø 8 mm	32 x 34 cm	1/10

POLYACRYL



### ROLKA WESTAN 18 CM Z KUWETA

WESTAN roller set with paint tray • Валик "WESTAN" + ручка + кювета  
• Westan Roller mit Farbewanne Set trafalet Westan cu tava





NUMER KATALOGOWY				
030 225	18 cm	18 cm Ø 6 mm	24 x 26 cm	1/20

POLYESTER



### ROLKA WESTAN Z KRATKA

WESTAN roller set with paint grid • Валик "WESTAN" с отжимной решеткой + ручка • Vestan Roller mit Abstreifgitter • Set trafalet Westan cu gratar

NUMER KATALOGOWY				
030 230	18 cm	18 cm Ø 6 mm	20 x 24 cm	1/20
030 231	23 cm	23 cm Ø 6 mm	27 x 30 cm	1/20



### MYJKA DO WAŁKÓW I PĘDZLI

Paint roller's washer • Устройство для мойки малярных валиков  
• Reinigungsgerät für Farbrollen • Dispozitiv curatare role

NUMER KATALOGOWY	
030 335	1

**motive**  
Jakość ma znaczenie



### EUROMAL

Euromal painting set • ЕВРОМАЛЬ • Anstreich-Set • Set trafalet Euromal

NUMER KATALOGOWY	
030 003	1/10





### ZAPAS DO EUROMALU 3 SZT.

Euromal refill pads - 3 pcs set • Запас для ЕВРОМАЛЯ (3 шт.)  
• Ersatzpads für Anstreich-Set • Rezerva pentru Euromal

NUMER  
KATALOGOWY



030 001

1/10



### KUBEK MALARSKI/WKŁADY

Painting pail/Painting pail liners • Малярная ручная емкость для краски • Farbtopf/Farbtopf Einsatz • Bol pentru vopseluri/Rezerva pentru bol pentru vopseluri

NUMER  
KATALOGOWY



030 420

kubek malarski/painting pail

1/10

030 421

wkłady/painting pail liners

1/10



### MIESZADEŁKO DO FARB

Paint stirrer • Мешалка для красок пластик • Farbrührer / Rührstab Kunststoff  
• Mixer pentru vopsea

NUMER  
KATALOGOWY



040 277

275 mm

1/20/1000



### KUWETA

Paint tray • Кювета • Farbwanne • Tava trafalet

NUMER  
KATALOGOWY



030 311

16 x 31 cm

1/90

030 312

34 x 38 cm

1/50



### KUWETA MALARSKA DUŻA/WKŁADY DO KUWETY

Paint tray • Кювета • Farbwanne • Tava trafalet

NUMER  
KATALOGOWY



030 357

kuweta/paint tray

54 x 34 cm

1

030 351

wkłady/paint tray liners

3

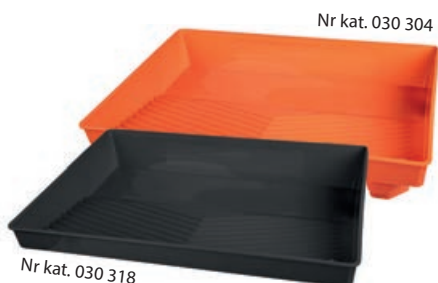

### KUWETA MALARSKA DUŻA/WKŁADY DO KUWETY

Paint tray • Кювета • Farbwanne • Tava trafalet

NUMER  
KATALOGOWY



030 304

kuweta/paint tray

54 x 38 cm

1

030 318

wkłady/paint tray liners



54 x 38 cm

3





**KUWETA MALARSKA**

Paint tray • Кювета • Farbwanne • Tava trafalet

NUMER KATALOGOWY		
030 305	12 x 20 cm	1/300
030 306	16 x 28 cm	1/180
030 308	25 x 31 cm	1/50
030 309	BIG	1/50



**WKŁAD PLASTIKOWY DO KUWETY**

Paint tray liner • Вкладыш в кювету "BIG" • Einlage für Farbwanne Big  
 • Rezerva din plastic pentru tava trafalet

NUMER KATALOGOWY		
030 300	16 x 28 cm	1/250
030 319	25 x 31 cm	1/100
030 310	32 x 34 cm	1/100

**KUWETA BIG BEN**

Big Ben™ Tray • Кювета Big Ben • Big Ben Farbwanne

NUMER KATALOGOWY			
BR412-21	3,75 L	21" (54 cm) x 16" (41 cm)	1/6

**KUWETA MALARSKA**

Jumbo-Koter® Tray • Кювета Jumbo-Koter • Farbwanne • Tava trafalet

NUMER KATALOGOWY		
BR403 4 1/2	4 1/2" (11 cm) x 15" (38,5 cm)	1/12

**KUWETA METALOWA**

Deluxe Metal Tray • Кювета Deluxe Metal • Metall Farbwanne

NUMER KATALOGOWY		
R402	11" (28 cm) x 16 1/2" (42 cm)	1/12



**WOOSTER®**



**WOOSTER®**



**WOOSTER®**







**WOOSTER®**



**WKŁAD DO KUWETY**

Tray Liners • Вкладыш в кювету • Einlage für Metall Farbwanne

NUMER KATALOGOWY		
R406	11" (28 cm) x 16 1/2" (42 cm)	1/48



**KRATKA MALARSKA**

Plastic paint grid • Малярная отжимная решетка • Abstreifgitter Kunststoff  
• Gratar plastic

NUMER KATALOGOWY		
030 301	20 x 24 cm	1/150
030 302	27 x 30 cm	1/100

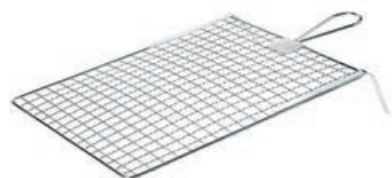

**KRATKA MALARSKA METALOWA**

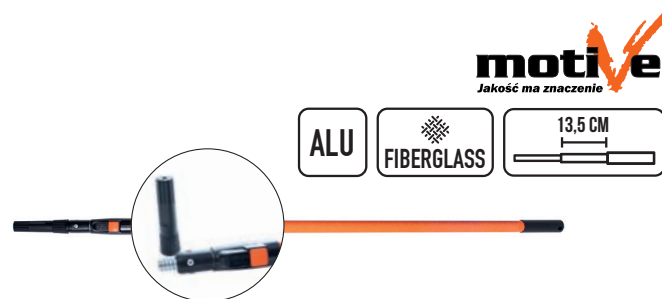

Metal paint grid • Малярная отжимная решетка металл  
• Abstreifgitter • Gratar metalic

NUMER KATALOGOWY		
030 303	26 x 30 cm	1/10/40



**KIJ TELESKOPOWY FIBER**



Fiberglass extension pole • Ручка телескопическая "FIBER"  
• Maler Teleskopstange • Prelungitor telescopic

NUMER KATALOGOWY		
030 507	0,8-1,4 m	1/10
030 508	1,4-2,4 m	1/10



**KIJ TELESKOPOWY ALUMINIOWY**

Aluminium extension pole • Ручка телескопическая алюминиевая  
• Maler Teleskopstange • Prelungitor telescopic

NUMER KATALOGOWY		
030 503	1-2 m	1/10
030 504	1,5-3 m	1/10



### KIJ TELESKOPOWY ALUMINIOWY

Aluminium extension pole • Ручка телескопическая алюминиевая  
 • Maler Teleskopstange • Prelungitor telescopic

NUMER KATALOGOWY	↔	
030 505	55-75 cm	1/20



### KIJ TELESKOPOWY METALOWY

Metal extension pole • Ручка телескопическая • Maler Teleskopstange  
 • Prelungitor telescopic

NUMER KATALOGOWY	↔	
030 501	1-2 m	1/10
030 502	1,5-3 m	1/10



### KIJ TELESKOPOWY

Extension Pole Sherlock GT® • Ручка телескопическая "Pole Sherlock GT"  
 • Teleskopstange • Prelungitor telescopic Sherlock GT®

NUMER KATALOGOWY	↔	
R091	122 - 244 cm	1/6
R092	183 - 366 cm	1/3
R090	61 - 122 cm	1/6

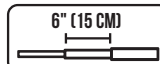

### ADAPTER DO KIJA TELESKOPOWEGO 2 SZT.



Conversion Tips For Extension Poles 2 pcs • Адаптер к телескопической  
 ручке 2 шт • Adapter für teleskopstange

NUMER KATALOGOWY	
R042	1/6



### WIADRO MALARSKIE

Paint bucket • Малярное ведро • Farbeimer • Galeata vopsea

NUMER KATALOGOWY		
030 314	8 L	1/40
030 315	12 L	1/20





**WOOSTER®**



**WIADRO MALARSKIE MAŁE**

4 Gallon Paint bucket • Малярное ведро • Farbeimer

NUMER KATALOGOWY			
8616	34,29 cm x 38,1 cm x 22,86 cm	15,15 L	1/3



**WOOSTER®**



**POKRYWA MAŁA**

4 Gallon Bucket lid • Крышка для ведра • Deckel für 4 Gallon Eimer

NUMER KATALOGOWY	
8626	1/3



**WOOSTER®**



**WIADRO MALARSKIE DUŻE**

Wide Boy bucket • Малярное ведро • Бояджийска кофа • Farbeimer

NUMER KATALOGOWY			
8614	35,56 cm x 60,96 cm x 25,4 cm	18,92 L	1/3



**WOOSTER®**



**POKRYWA DUŻA**

Wide Boy bucket lid • Крышка для ведра • Deckel für 5 Gallon Eimer

NUMER KATALOGOWY	
8624	1/3



**motive**  
Jakość ma znaczenie



**SKROBAK ALUMINIOWY**

Long, aluminium handle scraper • Скребок для стекол алюминиевый  
• Schaber • Razuitor

NUMER KATALOGOWY			
030 327	10 cm	20 cm	1/6/48
030 328	15 cm	40 cm	1/6/48





**OSTRZA SKROBAKA ALUMINIOWEGO ( 5 SZT.)**

Blades for long handle scraper • Лезвия для скребка для стекол алюминиевого  
 • Ersatzklingen für Schaber • Lame pentru răzuitor

NUMER KATALOGOWY	↔	
030 329	10 cm	1/12/144
030 330	15 cm	1/12/144



**SKROBAK DO SZYB**

Window scraper • Скребок для стекол (цикля) • Glasschaber • Răzuitor geam

NUMER KATALOGOWY	↔	
030 321	4 cm	1/12/144



**OSTRZA SKROBAKA DO SZYB**

Blades for window scraper • Лезвие для скребка для стекол • Ersatzklingen für Glasschaber • Lame pentru razuitor de geamuri

NUMER KATALOGOWY	↔	
110 006	4 cm	1/10/120



**SKROBAK DO SZYB**

Window scraper • Скребок для стекол (цикля) • Glasschaber • Răzuitor geam

NUMER KATALOGOWY	↔	
030 320	5 cm	1/25/100



**SKROBAK MALARSKI**

Paint Scraper • Малярный шабер • Farbschaber • Răzuitor geam

NUMER KATALOGOWY	↔	
030 325	11 cm	1/100



# DUŻA

**motive**   
Jakość ma znaczenie

## KUWETA MALARSKA

### DUŻA KUWETA MALARSKA TO NOWY PRODUKT OD

**MOTIVE**, który powstał z myślą o fachowcach zawodowo zajmujących się malowaniem dużych powierzchni. Gabaryty oraz pojemność kuwety pozwalają na wykorzystanie jej w pracy z szerokimi wałkami, których głównie używa się do malowania wielkich powierzchni, gdzie liczy się ilość pomalowanych metrów w krótkim czasie. Kuweta wykonana jest z odpornego tworzywa. Wykorzystasz ją zatem nie tylko do farb wodnych, ale również do lakierów i żywic. Kuweta z powodzeniem posłużyć może również jako miska warsztatowa do mycia elementów i części mechanicznych, a w sytuacjach awaryjnych do kuwety możesz nasypać żwirku dla kota i też zadziała. 😊

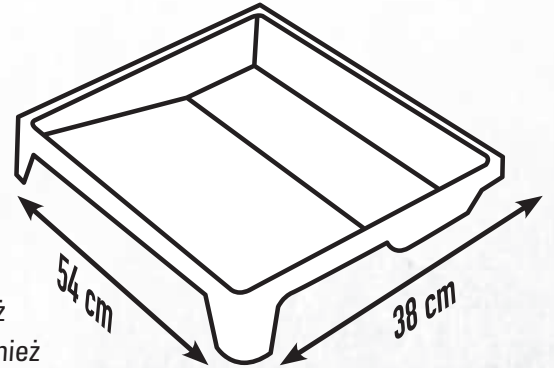

**W OFERCIE ZNAJDZIESZ RÓWNIEŻ WKŁADY DO KUWETY**

DZIĘKI NIM SZYBKO ZMIENISZ KOLOR BEZ KONIECZNOŚCI MYCIA KUWETY



Głębokie dno kuwety pozwala na rzadsze dolewanie farby

Wzmocnione, wyprofilowane ranty

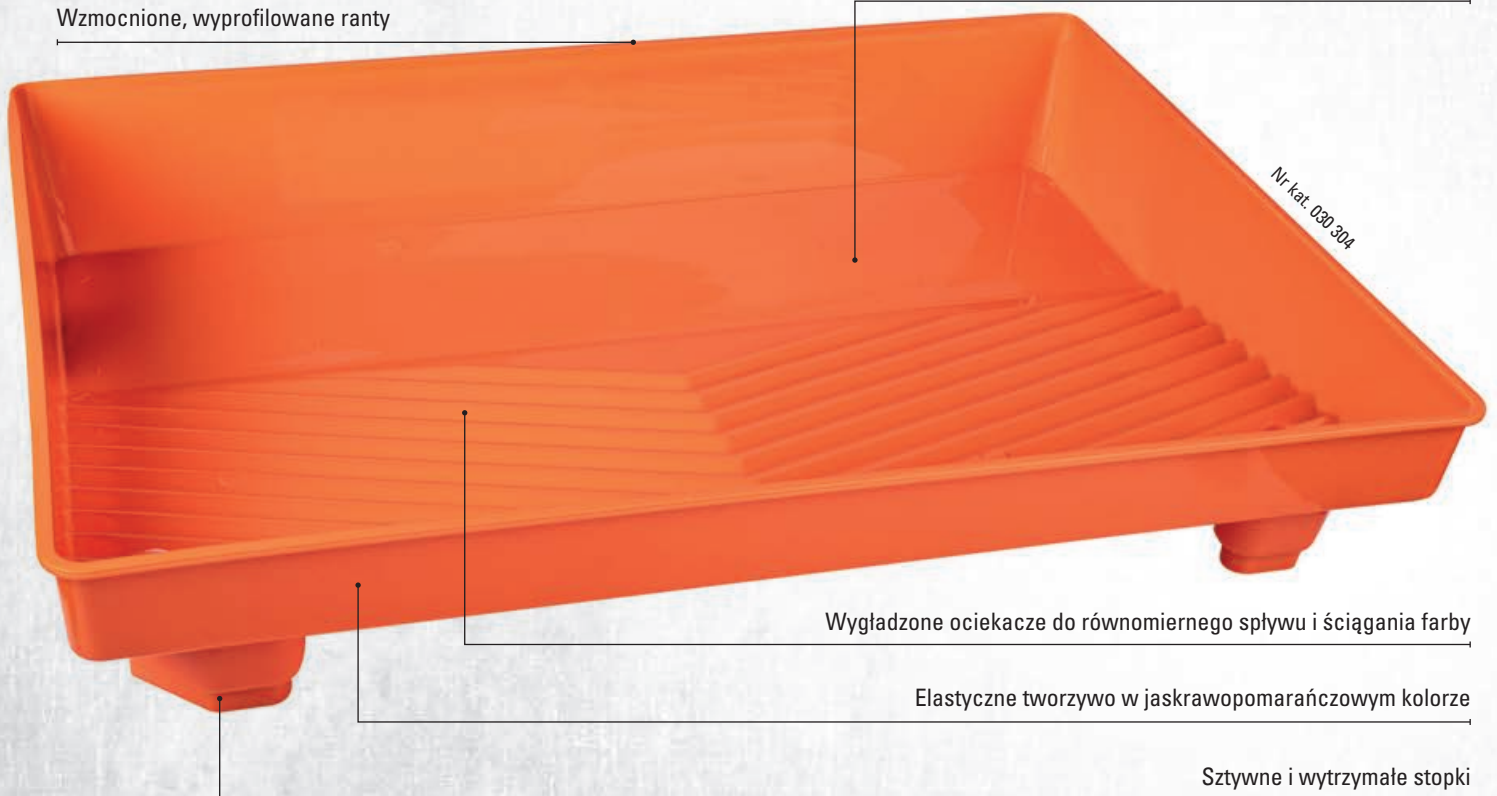

Nr kat. 030.304

Wygładzone ociekacze do równomiernego spływu i ściągania farby

Elastyczne tworzywo w jaskrawopomarańczowym kolorze

Szttywne i wytrzymałe stopki

**motive**   
Jakość ma znaczenie

# NARZĘDZIA BUDOWLANE

СТРОИТЕЛЬНЫЕ ИНСТРУМЕНТЫ • CONSTRUCTION TOOLS

• BAUWERKZEUGE • UNELTE CONSTRUCTII



# LEKKIE RAJBERKI

## NIEWIELKA WAGA I ELASTYCZNE OSTRZE

**HI-FLEX**

**NOWOŚĆ**  
W NASZEJ OFERCIE



## WENECKA

Przeznaczona do pracy z masami strukturalnymi nakładanymi różnymi sposobami.



## TRAPEZOWA

Przeznaczona do pracy z farbami, masami dekoracyjnymi oraz strukturalnymi.

Odpowiednio wyprofilowany gumowany uchwyt

Wytrzymała poliamidowa stopka znacząco redukująca wagę narzędzia

Wysokiej jakości elastyczna blacha nierdzewna o grubości 0,3 mm

Zaokrąglone narożniki niepowodujące rys podczas pracy



**240 mm**  
nr kat 040 758

**140/240 mm**  
nr kat 040 759

# ZAMIESZAJ W MASIE!

## NASZYM NOWYM MIESZADŁEM

Długość całkowita = 500 mm

Sztynny pręt ocynkowany o przekroju sześciokąta (mocowanie HEX)



Specjalnie zaprojektowany kształt łopatek umożliwia idealne wymieszanie płynnej substancji

Odpowiednie wyprofilowanie łopatek znacząco zmniejsza również rozchlapywanie masy podczas mieszania

Dobrze dobrana grubość stali gwarantuje właściwą sztywność i długą żywotność wszystkich elementów

### DOSKONAŁE MIESZADŁO DO:

- ✓ żywic epoksydowych, poliuretanowych itp.
- ✓ posadzek w formie płynnej
- ✓ farb i lakierów
- ✓ wszelkich mas płynnych, w których ważne jest zniwelowanie napowietrzenia mieszanej substancji

Średnica głowicy roboczej = 90 mm



nr kat 040 857

PRODUKT  
POLSKI





**motive**

Jakość ma znaczenie



#### RAJBERKA NIERDZEWNA HI-FLEX STOPKA ALUMINIOWA

Plastering trowel, stainless steel, soft-grip handle • Гладилка нерж. на алюмин. подст. • Glättkelle mit Soft-Griff • Gletiera otel inoxidabil

NUMER KATALOGOWY			
040 940	11 cm	28 cm	1/2
040 942	11 cm	41 cm	1/3



**motive**

Jakość ma znaczenie



#### RAJBERKA NIERDZEWNA

Plastering trowel, stainless steel, soft-grip handle • Гладилка нерж. • Glättkelle mit Soft-Griff • Gletiera otel inoxidabil

NUMER KATALOGOWY				
040 750	aluminium	13 cm	28 cm	1/10
040 133	kompozyt/polyamide	13 cm	28 cm	1/10



**motive**

Jakość ma znaczenie



#### RAJBERKA NIERDZEWNA ZĘBATA STOPKA ALUMINIOWA

Square notched tiling trowel, soft-grip handle • Гладилка нерж. на алюмин. подст. • Glättkelle gezahnt mit Soft-Griff • Gletiera inox

NUMER KATALOGOWY					
040 751	aluminium	13 cm	28 cm	4 mm	1/10
040 752	aluminium	13 cm	28 cm	6 mm	1/10
040 753	aluminium	13 cm	28 cm	8 mm	1/10
040 754	aluminium	13 cm	28 cm	10 mm	1/10
040 749	aluminium	13 cm	28 cm	12 mm	1/10
040 757	aluminium	13 cm	28 cm	15 mm	1/10
040 128	kompozyt/polyamide	13 cm	28 cm	4 mm	1/10
040 129	kompozyt/polyamide	13 cm	28 cm	6 mm	1/10
040 131	kompozyt/polyamide	13 cm	28 cm	8 mm	1/10
040 132	kompozyt/polyamide	13 cm	28 cm	10 mm	1/10



**motive**

Jakość ma znaczenie



#### RAJBERKA ALU. UCHWYT KOREK

Cork grip handle plastering trowel • Гладилка нерж. на алюмин. подст., ручка из пробки • Glättkelle mit Korkgriff • Gletieră, mâner din plută

NUMER KATALOGOWY			
040 827	12 cm	28 cm	1/5
040 828	12 cm	36 cm	1/5
040 829	12 cm	48 cm	1/5



**motive**

Jakość ma znaczenie



#### RAJBERKA WENECKA

Venetian plastering trowel • Гладилка венецкая • Venezianische Glättkelle • Gletiera rotunjita tip venetiana

NUMER KATALOGOWY			
040 755	7,5 x 9,5 cm	24 cm	1/10



### HI-FLEX RAJBERKA WENECKA

Venetian plastering trowel • Гладилка венецкая • Venezianische Glättkelle  
• Gletiera rotunjita tip venetiana

NUMER KATALOGOWY			
040 758	8 - 9,5 cm	24 cm	1/10



### HI-FLEX RAJBERKA TRAPEZOWA

Trapezoid trowel Hi-Flex • Гладилка нерж. • Venezianische Glättkelle  
Trapezform Hi-Flex • Gletiera otel inoxidabil

NUMER KATALOGOWY			
040 759	13 cm	14/24 cm	1/10



### RAJBERKA NIERDZEWNA ZĄB PÓŁOKRĄGLY

U notched Trowel • Гладилка нерж. полукруглый зуб, ручка • Glättkelle  
halbrund zahn • Gletiera zintata dinti profil semirodund

NUMER KATALOGOWY				
040 756	13 cm	27 cm	10 mm	1/10



### RAJBERKA NIERDZ. DO GIPSU ALUMINIOWA

Wooden grip handle plaster finishing trowel • Гладилка нерж. для гипса ал.  
• Trockenbau Glättkelle • Gletiera otel inoxidabil

NUMER KATALOGOWY			
040 148	12 cm	40 cm	1/6



### RAJBERKA NIERDZEWNA STOPKA ALUMINIOWA

Plastering trowel, stainless steel, wooden handle • Гладилка нерж. на алюмин.  
подст. • Glättkelle rostfrei • Gletiera otel inoxidabil

NUMER KATALOGOWY			
040 114	13 cm	27 cm	1/10





#### RAJBERKA NIERDZEWNA ZĘBATA STOPKA ALUMINIOWA

Square notched tiling trowel, wooden handle • Гладилка нерж. на алюмин.  
подст. • Glättkelle gezahnt • Gletiera zimtata

NUMER KATALOGOWY				
040 110	13 cm	27 cm	4 mm	1/10
040 111	13 cm	27 cm	6 mm	1/10
040 112	13 cm	27 cm	8 mm	1/10
040 113	13 cm	27 cm	10 mm	1/10



#### RAJBERKA NIERDZ. GAT. I

Plastering trowel, stainless steel, plastic handle, I quality • Гладилка нерж.  
с пластм. ручк. сорт 1 • Glättkelle mit Kunststoffgriff • Gletiera inox

NUMER KATALOGOWY			
040 144	13 cm	27 cm	1/10



#### RAJBERKA NIERDZ. GAT.II

Plastering trowel, stainless steel, plastic handle, II quality • Гладилка нерж.  
с пластм. ручк. сорт 2 • Glättkelle mit Kunststoffgriff • Gletiera inox

NUMER KATALOGOWY			
040 145	13 cm	27 cm	1/10



#### RAJBERKA NIERDZEWNA ZĘBATA

Square notched tiling trowel • Гладилка нерж. с пластм. ручк. Зубчатая  
• Glättkelle mit Kunststoffgriff • Gletiera zimtata

NUMER KATALOGOWY				
040 140	13 cm	27 cm	4 mm	1/10
040 141	13 cm	27 cm	6 mm	1/10
040 142	13 cm	27 cm	8 mm	1/10
040 143	13 cm	27 cm	10 mm	1/10
040 146	13 cm	27 cm	12 mm	1/10



#### RAJBERKA NIERDZEWNA UCHWYT DREWNIANY

Plastering trowel, stainless steel, wooden handle • Гладилка нерж. с деревян.  
ручкой • Schweizer Glättkelle rostfrei • Gletiera otel tip elvetiana

NUMER KATALOGOWY			
040 124	13 cm	38 cm	1/10
040 123	13 cm	48 cm	1/10
040 125	13 cm	58 cm	1/18
040 127	13 cm	78 cm	1/18





#### RAJBERKA NIERDZEWNA UCHWYT DREWNIANY

Square notched tiling trowel, wooden handle • Гладилка нерж. с деревян. ручкой • Schweizer Glättkelle rostfrei • Gletiera otel inoxidabil

NUMER KATALOGOWY				
040 120	13 cm	48 cm	6 mm	1/10
040 121	13 cm	48 cm	8 mm	1/10
040 122	13 cm	48 cm	10 mm	1/10



#### RAJBERKA NIERDZEWNA UCHWYT PLASTIKOWY

Plastering trowel, stainless steel, plastic handle • Гладилка нерж. • Schweizer Glättkelle mit Kunststoffgriff • Gletiera inox

NUMER KATALOGOWY			
040 151	13 cm	48 cm	1/10



#### RAJBERKA PLASTIKOWA

Plastic trowel • Гладилка пластмассовая • Glättkelle Plastik • Drisca plastic

NUMER KATALOGOWY			
040 102	13 cm	27 cm	1/10



#### RAJBERKA ABS

Plastic trowel ABS • Гладилка ABS • Glättkelle Kunststoff • Drisca plastic ABS

NUMER KATALOGOWY			
040 101	13 cm	28 cm	10



#### PACA STYROPIANOWA

Foamed polystyrene float • Терка из пенопласта • Styropor-Reibebrett • Drisca polistiren

NUMER KATALOGOWY			
040 045	13 cm	27 cm	10
040 046	13 cm	40 cm	10
040 047	13 cm	60 cm	10
040 048	13 cm	70 cm	10
040 049	14 cm	100 cm	10
040 050	32 cm	17 cm	10





#### PACA STYROPIANOWA Z GĄBKĄ MIĘKKĄ

Foamed polystyrene float with soft sponge • Терка из пенопласта с мягкой губкой • Styropor-Reibebrett mit feinporigen Schwamm  
• Gletiera polistiren cu burete fin

NUMER  
KATALOGOWY



040 056

14 cm

28 cm

10



#### PACA STYROPIANOWA Z GĄBKĄ TWARDĄ

Foamed polystyrene float with tough sponge • Терка из пенопласта с твердой губкой • Styropor-Reibebrett mit grobporigen Schwamm  
• Gletiera polistiren cu burete poros

NUMER  
KATALOGOWY



040 057

14 cm

28 cm

10



#### PACA STYROPIANOWA Z FILCEM 5 mm

Foamed polystyrene float with felt 5 mm • Терка из пенопласта с фетровой накладкой 5 мм • Styropor-Reibebrett mit Filz • Gletiera polistiren cu pãslã

NUMER  
KATALOGOWY



040 055

14 cm

28 cm

10



#### PACA POLIURETANOWA

Polyurethane float • Терка полиуретановая • Polyurethan-Reibebrett  
• Drisca poliuretan

NUMER  
KATALOGOWY



040 051

14 cm

28 cm

1/6/36

040 052

18 cm

32 cm

1/6/36



**motive**  
Jakość ma znaczenie

#### PACA Z FILCEM 8 mm

Plastic trowel with felt 8 mm • Терка пласт. с фетровой накладкой 8 мм  
• Reibebrett mit Filz • Drisca cu pasla

NUMER  
KATALOGOWY



040 080

14 cm

28 cm

1/10



**motive**  
Jakość ma znaczenie

#### PACA Z GĄBKĄ GUMOWĄ 18 mm

Plastering sponge trowel • Терка пласт. с резиновой губкой 18 мм  
• Reibebrett mit grobporigen Schwammgummi • Gletiera cu burete cauciucat

NUMER  
KATALOGOWY



040 081

14 cm

28 cm

1/10



### PACA PRZEGUBOWA Z HYDROGUMĄ

Celling sponge float • Поплавок из ПВХ материала с гидрорезиной  
• Deckenreibebrett • Rasper de aluminiu cu burete

NUMER KATALOGOWY			
040 078	20 cm	40 cm	1/10



### PACA Z GĄBKĄ PONACINANĄ HYDRO 30 mm

Trowel with scatching sponge HYDRO 30 mm • Терка пласт. с надрезанной резиновой губкой HYDRO 30 mm • Fliesenwaschbrett Hydro gerastert  
• Drisca burete hidro-absorbant profilată

NUMER KATALOGOWY			
040 086	14 cm	28 cm	1/10



### PACA Z GĄBKĄ PONACINANĄ 25 mm

Tiling float with scatching sponge 25 mm • Терка пласт. с надрезанной резиновой губкой 25 mm • Fliesenwaschbrett gerastert • Drisca burete

NUMER KATALOGOWY			
040 082	14 cm	28 cm	1/10



### PACA Z GĄBKĄ POROWATĄ 25 mm

Tiling float with sponge 25 mm • Терка пласт. с мягкой пористой губкой 25 mm • Reibebrett mit feinporigen Schwamm • Drisca burete

NUMER KATALOGOWY				
040 083	MIĘKKA/SOFT	14 cm	28 cm	1/10
040 084	TWARDA/HARD	14 cm	28 cm	1/10



### PACA Z GUMĄ 8 mm

Grout float 8 mm • Терка с рез. покрытием 8 mm • Reibebrett mit Gummi  
• Drisca cauciuc

NUMER KATALOGOWY			
040 085	14 cm	28 cm	1/10





**PACA Z FILCEM 5 mm**

Plastering trowel with felt 5 mm • Терка пласт. с фетровой накладкой 5 мм  
• Reibebrett Filz 5 mm

NUMER  
KATALOGOWY



040 060

14 cm

28 cm

1/10



**ZAPAS FILC 8 mm**

Felt refill 8 mm • Фетровые накладки 8 мм • Filz 8 mm für Reibebrett  
• Rezerva pâslă pentru gletiera

040 061

14 cm

28 cm

1/10

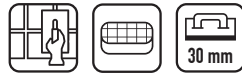

**PACA Z GĄBKĄ HYDROCHŁONNĄ PONACINANĄ 30 mm**

Trowel with scatching sponge 30 mm • Терка пласт. с надрезанной резиновой губкой 30 мм • Fliesenwaschbrett • Drisca burete hidro-absorbant profilată

NUMER  
KATALOGOWY



040 066

13,5 cm

27,5 cm

1/10



**PACA Z GĄBKĄ GUMOWĄ 18 mm**

Plastic trowel with rubber sponge 18 mm • Терка пласт. с резиновой губкой 18 мм • Reibebrett mit Schwammgummi • Drisca burete

NUMER  
KATALOGOWY



040 065

14 cm

28 cm

1/10

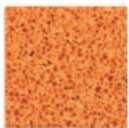

**PACA Z GĄBKĄ POROWATĄ MIĘKKĄ**

Plastic trowel with soft sponge • Терка пласт. с мягкой пористой губкой  
• Reibebrett mit feinporigen Schwamm • Drisca burete fin

NUMER  
KATALOGOWY



040 070

14 cm

28 cm

1/10



**PACA Z GĄBKĄ PONACINANĄ 30 mm**

Trowel with scatching sponge 30 mm • Терка пласт. с надрезанной резиновой губкой 30 мм • Fliesenwaschbrett • Drisca burete

NUMER  
KATALOGOWY



040 072

14 cm

28 cm

1/10



**PACA Z GĄBKĄ POROWATĄ TWARDĄ**

Plastic trowel with tough sponge • Терка пласт. с тверд. пористой губкой  
• Reibebrett mit grobporigen Schwamm • Drisca burete spongios

NUMER  
KATALOGOWY



040 071

14 cm

28 cm

1/10





### PACA Z GUMĄ

Grout float • Тёрка с рез. покрытием • Reibebrett Moosgummi • Drisca cauciuc

NUMER KATALOGOWY			
040 075	14 cm	28 cm	1/10



### PACA TARKA PRZELOTOWA

Polystyrene rasp with through holes • Тёрка для пенопласта • Schleifbrett für Styropor • Razuitor polistiren

NUMER KATALOGOWY			
040 037	16 cm	38 cm	1/5

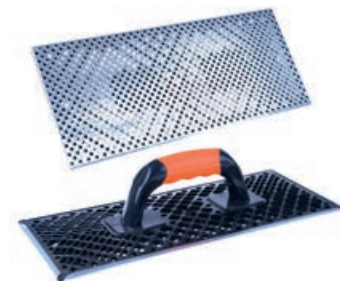

### PACA TARKA PEŁNA

Heavy duty polystyrene rasp • Тёрка для пенопласта усиленная • Schleifbrett • Razuitor polistiren

NUMER KATALOGOWY			
040 053	13 cm	27 cm	1/10



### PACA TARKA PRZELOTOWA WZMOCNIONA

Heavy duty polystyrene rasp • Тёрка для пенопласта усиленная • Schleifbrett • Razuitor polistiren

NUMER KATALOGOWY			
040 054	13 cm	27 cm	1/10
040 038	16 cm	38 cm	1/10



### PACA TARKA

Polystyrene rasp • Тёрка для пенопласта • Schleifbrett für Styropor • Razuitor polistiren

NUMER KATALOGOWY			
040 040	13 cm	27 cm	1/10
040 041	18 cm	40 cm	1/10



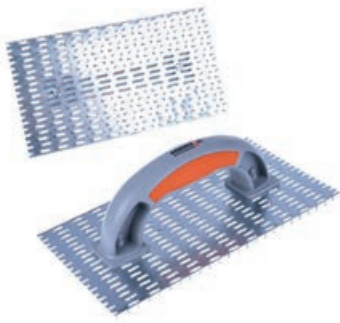

**motive**  
Jakość ma znaczenie



**ZDZIERAK DO TYNKÓW METAL**

Render scraper • Скребок для штукатурки металл • Putzkratzer  
• Rabot pentru tencuiala

NUMER  
KATALOGOWY



040 044

13 cm

25 cm

1/10



**ZDZIERAK DO TYNKÓW**

Plaster rasp • Скребок для штукатурки • Putzhobel • Rabot pentru tencuiala

NUMER  
KATALOGOWY



040 042

8 cm

40 cm

1/10



**ZDZIERAK ALUMINIOWY**

Plaster alu rasp • Скребок алюминиевый • Putzhobel ALU  
• Rabot aluminu pentru tencuiala

NUMER  
KATALOGOWY



040 043

9 cm

45 cm

1/20



**motive**  
Jakość ma znaczenie



EDELSTAHL  
Rost  
frei

**KIELNIA FUGOWA NIERDZEWNA**

Tuck Pointing Trowel, stainless steel • Шпатель для швов нержав.  
• Fugenkelle, rostfrei • Mistris rosturi pentru zidarie

NUMER  
KATALOGOWY



040 701

8 mm

1/10

040 702

10 mm

1/10

040 703

12 mm

1/10



**motive**  
Jakość ma znaczenie



EDELSTAHL  
Rost  
frei

**KIELNIA KĄTOWA WEWNĘTRZNA**

Internal corner trowel • Кельма угловая внутренняя • Eckenkelle innen  
• Mistris colt interior

NUMER  
KATALOGOWY



040 720

65 mm

80 mm

1/10



**motive**  
Jakość ma znaczenie



EDELSTAHL  
Rost  
frei

**KIELNIA KĄTOWA ZEWNĘTRZNA**

External corner trowel • Кельма угловая внешняя • Eckenkelle außen  
• Mistris colt exterior

NUMER  
KATALOGOWY



040 721

65 mm

80 mm

1/10



#### KIELNIA SZTUKATORSKA NIERDZEWNA

Margin trowel, stainless steel • Кельма штукатурная нерж.  
• Stukkateurspachtel • Mistrie dreapta

NUMER KATALOGOWY		
040 725	50 mm	1/10
040 726	80 mm	1/10
040 727	100 mm	1/10
040 728	120 mm	1/10

#### KIELNIA SZTUKATORSKA KOREK

Stucco trowel, stainless steel, cork grip handle • Кельма штукатурная нерж.,  
ручка из пробки • Stukkateurspachtel mit Korkgriff • Mistrie dreapta

NUMER KATALOGOWY		
040 823	60 mm	1/5
040 824	80 mm	1/5
040 825	100 mm	1/5
040 826	120 mm	1/5

#### KIELNIA NIERDZEWNA TRAPEZOWA

Stainless steel bucket trowel • Кельма трапеция нерж.  
• Maurerkelle, rostfrei • Mistrie trapez

NUMER KATALOGOWY		
040 730	130 mm	1/10
040 731	160 mm	1/10
040 732	180 mm	1/10

#### KIELNIA TRAPEZOWA KOREK

Bricklayer trapeze shape, stainless steel, cork grip handle • Кельма трапеция  
нерж., ручка из пробки • Maurerkelle, rostfrei • Mistrie trapez

NUMER KATALOGOWY		
040 820	140 mm	1/5
040 821	160 mm	1/5
040 822	180 mm	1/5

#### KIELNIA TRÓJKĄTNA NIERDZEWNA

Bricklaying trowel, stainless steel • Кельма треугольная нерж.  
Berliner Maurerkelle • Mistrie triunghiulara

NUMER KATALOGOWY		
040 705	180 mm	1/10
040 706	200 mm	1/10





**motive**  
Jakość ma znaczenie

#### KIELNIA TRÓJKĄTNA SZLIFOWANA

Grinded triangular brick trowel • Кельма треугольная шлифованная  
• Mistle triunghiulara

NUMER KATALOGOWY		
040 711	180 mm	1/10
040 712	200 mm	1/10
040 713	220 mm	1/10



EDELSTAHL  
Rost  
frei

#### KIELNIA FUGOWA NIERDZEWNA

Tuck Pointing Trowel, stainless steel • Шпатель для швов нержав.  
• Fugenkelle, rostfrei • Mistle rosturi pentru zidarie

NUMER KATALOGOWY		
040 001	8 mm	1/10/50
040 002	10 mm	1/10/50
040 003	12 mm	1/10/50



EDELSTAHL  
Rost  
frei

#### KIELNIA KĄTOWA WEWNĘTRZNA

Internal corner trowel • Кельма угловая внутренняя • Eckenkelle innen  
• Mistle colt interior

NUMER KATALOGOWY			
040 020	65 mm	80 mm	1/10/50



EDELSTAHL  
Rost  
frei

#### KIELNIA KĄTOWA ZEWNĘTRZNA

External corner trowel • Кельма угловая внешняя • Eckenkelle außen  
• Mistle colt exterior

NUMER KATALOGOWY			
040 021	65 mm	80 mm	1/10/50



EDELSTAHL  
Rost  
frei

#### KIELNIA SZTUKATORSKA NIERDZEWNA

Margin trowel • Кельма штукатурная нерж. • Stukkateurspachtel, rostfrei  
• Mistle dreapta

NUMER KATALOGOWY		
040 025	50 mm	1/10/50
040 026	80 mm	1/10/50
040 027	100 mm	1/10/50





#### KIELNIA NIERDZEWNA TRAPEZOWA

Stainless steel bucket trowel • Кельма трапеция нерж. • Maurerkelle, rostfrei  
• Mistrie trapez

NUMER KATALOGOWY		
040 030	130 mm	1/10/50
040 031	160 mm	1/10/50
040 032	180 mm	1/10/50



#### KIELNIA TRAPEZOWA CZARNA

Bucket trowel, black • Кельма трапеция черная • Trapezkelle, schwarz  
• Mistrie trapez

NUMER KATALOGOWY		
040 009	130 mm	1/50
040 010	180 mm	1/50
040 011	200 mm	1/50



#### KIELNIA TRÓJKĄTNA NIERDZEWNA

Bricklaying trowel, rostfrei • Кельма треугольная нерж. • Berliner Maurerkelle  
• Mistrie triunghiulara

NUMER KATALOGOWY		
040 005	180 mm	1/10/25
040 006	200 mm	1/10/25



#### KIELNIA MURARSKA CZARNA

Bricklaying trowel, black • Кельма каменщика • Berliner Maurerkelle  
• Mistrie triunghiulara

NUMER KATALOGOWY		
040 015	180 mm	1/50
040 016	200 mm	1/50



#### KIELNIA DO GAZOBETONU

Trowel for aerated concrete • Кельма по газобетону • Porenbetonkelle  
• Mistrie BCA

NUMER KATALOGOWY		
040 035	115 mm	1/10
040 036	240 mm	1/10





# ALU RE-FLEX

SZPACHLE Z WYMIENNYMI OSTRZAMI

**motive**  
Jakość ma znaczenie

**ALUMINIOWE SZPACHLE ALU RE-FLEX.** Przeznaczone są do gipsów, tynków cementowo-wapiennych, kwarcowych, jak również lekkich tynków maszynowych, a nawet klejów. Aluminiowe szpachle Motive to precyzyjne narzędzia do wydajnej pracy przy nakładaniu wspomnianych mas na powierzchnię ścian i sufitów. Wykonane są z solidnego anodowanego profilu aluminiowego, dzięki czemu łatwo doprowadzisz je do czystości po zakończonej pracy. Niewątpliwie atutem naszych szpachli jest wygoda ich użytkowania oraz łatwa wymiana ostrzy, co daje użytkownikowi możliwość pracy z różnymi masami.



250



040.842

400



040.855

600



040.830

800



040.831

1000



040.832



Zaokrąglone naroża części roboczej

Korpus z anodowanego, wzmocnionego wewnątrz profilu

Wygodny, ergonomiczny kształt

**ŁATWA WYMIANA OSTRZA:**  
ODKRĘCASZ • ZDEJMUJESZ ZAŚLEPKĘ • WYSUWASZ  
OSTRZE • WSUWASZ NOWE OSTRZE • ZAKŁADASZ  
ZAŚLEPKĘ • PRZYKRĘCASZ

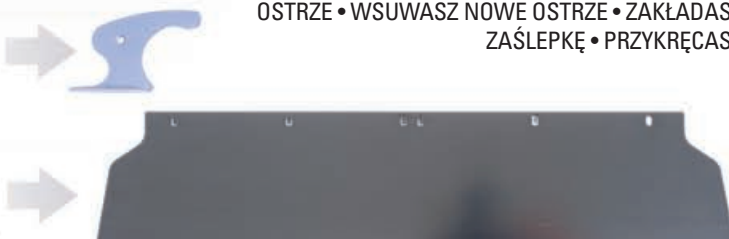



### ALUMINIOWE SZPACHLE DO MAS ALU RE-FLEX

Skimming spatula • Шпатель • Flächenspachtel • Gletiera profesionala

NUMER KATALOGOWY	↔	
040 842	250 mm	1
040 855	400 mm	1
040 830	600 mm	1
040 831	800 mm	1
040 832	1000mm	1

### OSTRZA DO SZPACHLI

Skimming spatula blade • Лезвие для шпателя алю для гипса  
• Ersatzklinge für Flächenspachtel • Lama pentru spatula

NUMER KATALOGOWY	↓	↔	
040 843	0,3 mm	250 mm	1/50
040 854	0,3 mm	400 mm	1/20
040 833	0,3 mm	600 mm	1/20
040 834	0,3 mm	800 mm	1/20
040 835	0,3 mm	1000 mm	1/20
040 839	0,5 mm	600 mm	1/20
040 840	0,5 mm	800 mm	1/20

## ADAPTER DO SZPACHLI ALUMINIOWYCH

### ADAPTER DO SZPACHLI ALUMINIOWYCH

Skimming spatula adaptor • Адаптер для шпателя • Adapter für Flächenspachtel mit Wechselblattsystm • Maner-Adaptor pentru gletiera profesionala

NUMER KATALOGOWY	
040 851	1/4



Regulacja kąta nachylenia adaptera

Dwie śruby do szybkiego montażu

Dwa sposoby mocowania kija teleskopowego (gwint/wcisk)

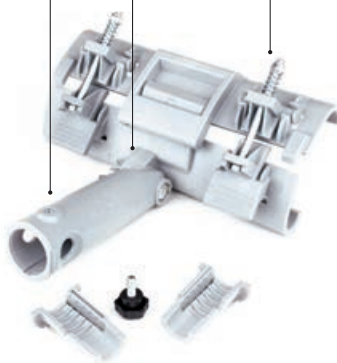

### POŁĄCZENIE WKRĘCANE

Pasuje do większości kijów teleskopowych z końcówką z gwintem amerykańskim (patrz: katalog str. 86-87)

### POŁĄCZENIE WCISKANE

Pasuje do kijów teleskopowych z typową końcówką stożkową (patrz: katalog str. 86-87)

### ZESTAW SZPACHLI ALU RE-FLEX Z WALIZKĄ / WALIZKA

Skimming spatula set in box • Flächenspachtel-Set im Koffer  
• Set pentru glet



NUMER KATALOGOWY		↔	
030 507	Kij teleskopowy	0,8-1,4 m	1
040 842	Szpachla do gładzi	250 mm	1
040 855	Szpachla do gładzi	400 mm	1
040 849	040 830 Szpachla do gładzi	600 mm	1
	040 831 Szpachla do gładzi	800 mm	1
	040 832 Szpachla do gładzi	1000 mm	1
	040 851 Adapter do szpachli		1
040 845	Zestaw szpachli z walizką + rolka do gładzi		1



# SZPACHLE POWIERZCHNIOWE RE-FLEX

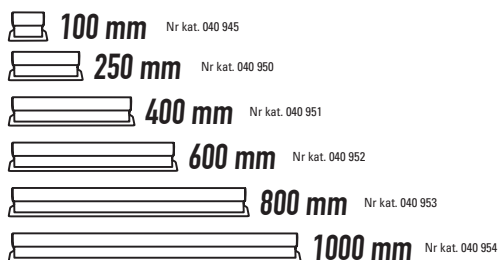

## SZEŚĆ DŁUGOŚCI SZPACHLI

W ofercie sześć długości szpachli, co daje gwarancję udanej pracy na każdej powierzchni.

## ŁATWA WYMIANA OSTRZY

W standardzie nierdzewne i elastyczne ostrza o grubości 0,3 mm. Dostępne są również ostrza mocniejsze, o grubości 0,5 mm.



## LEKKI PROFIL Z TWORZYWA SZTUCZNEGO

Lekki i ergonomiczny profil to duże ułatwienie, zwłaszcza dla osób wykonujących gładzie przez kilka godzin dziennie i to na dużych powierzchniach.

## WSPÓŁPRACA Z ADAPTEREM I KIJEM TELESKOPOWYM

Kompatybilność szpachli z adapterem, który wraz z kijem teleskopowym pozwala sięgnąć dalej i wyżej, daje większy zasięg i swobodę ruchu. To mniej wdrapywania się na drabinę i znacznie łatwiejszy dostęp do wysokich i oddalonych od nas miejsc.



### SZPACHLE DO GŁADZI

Skimming spatula Re-Flex  
• Flächenspachtel Re-Flex  
• Gletiera profesionala Re-Flex

NUMER KATALOGOWY	↔	↔	↔
040 945	100 mm	↔	1
040 950	250 mm	↔	1
040 951	450 mm	↔	1
040 952	600 mm	↔	1
040 953	800 mm	↔	1
040 954	1000 mm	↔	1

### ZESTAW SZPACHLI Z ADAPTEREM I KIJEM W WALIZCE

Skimming spatula set in box • Flächenspachtel-Set im Koffer • Prelungitor cu maner pt gletiera profesionala

NUMER KATALOGOWY	↔	↔	↔	
040 906	030 507	Kij teleskopowy	0,8 - 1,4 m	1
	040 851	Adapter		1
	040 950	Szpachla do gładzi	250 mm	1
	040 951	Szpachla do gładzi	450 mm	1
	040 952	Szpachla do gładzi	600 mm	1
	040 953	Szpachla do gładzi	800 mm	1
040 954	Szpachla do gładzi	1000 mm	1	

### ZESTAW SZPACHLI Z ADAPTEREM, KIJEM I ROLKĄ DO GŁADZI W WALIZCE

Skimming spatula set in box • Flächenspachtel-Set im Koffer • Prelungitor cu maner pt gletiera profesionala

NUMER KATALOGOWY	↔	↔	↔	
040 907	030 507	Kij teleskopowy	0,8 - 1,4 m	1
	040 851	Adapter		1
	030 200	Rolka do gładzi	22 cm	1
	040 951	Szpachla do gładzi	450 mm	1
	040 952	Szpachla do gładzi	600 mm	1
	040 953	Szpachla do gładzi	800 mm	1



**motive**  
Jakość ma znaczenie

## SZPACHLE DO MAS

**HI-FLEX**  
SZPACHLE I KIJE TELESKOPOWE

SZPACHLE I KIJE TELESKOPOWE DO GŁADZI HI-FLEX są doskonałymi narzędziami do wydajnej pracy przy nakładaniu gładzi na ścianach i sufitach. Występujące w pięciu szerokościach szpachle oraz dostępne w dwóch długościach kije teleskopowe to niezbędny i profesjonalny system do szybkiego rozprowadzania mas na dużych powierzchniach

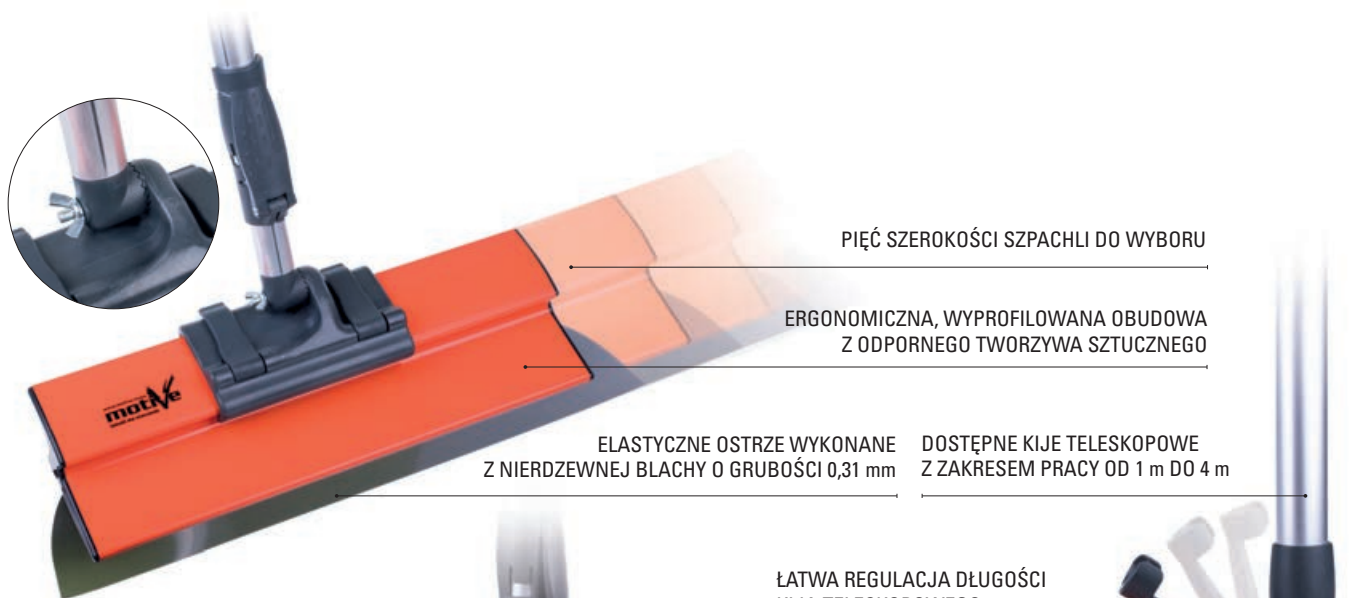

### SZPACHLE DO GŁADZI

Skimming spatula Hi-Flex • Flächenspachtel Hi-Flex  
• Gletiera profesionala Hi-Flex

NUMER KATALOGOWY	↔	
040 910	250 mm	1
040 911	450 mm	1
040 912	600 mm	1
040 913	800 mm	1
040 914	1000 mm	1

### KIJE TELESKOPOWE Z ADAPTEREM

Extendable alloy handle • Verlängerungsstab für Flächenspachtel • Prelungitor cu maner pt gletiera profesionala

040 920	1 m - 2 m	1
040 921	2 m - 4 m	1



### ZESTAW SZPACHLI Z WALIZKĄ / WALIZKA

Skimming spatula set in box / Hi-Flex box • Flächenspachtel-Set im Koffer/ Koffer für Flächenspachtel-Set • Prelungitor cu maner pt gletiera profesionala

NUMER KATALOGOWY	↔	
040 905	040 920 Kij teleskopowy	1 m - 2 m 1
	040 910 Szpachla do gładzi	250 mm 1
	040 911 Szpachla do gładzi	450 mm 1
	040 912 Szpachla do gładzi	600 mm 1
	040 913 Szpachla do gładzi	800 mm 1
	040 914 Szpachla do gładzi	1000 mm 1
040 904	WALIZKA (bez wyposażenia)	1



040 904



### SZPACHLA DO GŁADZI

Skimming spatula • Шпатель • Flächenspachtel • Gletiera profesionala

NUMER KATALOGOWY		
040 690	250 mm	1
040 691	450 mm	1
040 692	600 mm	1
040 693	800 mm	1
040 694	1000 mm	1



### OSTRZA DO SZPACHLI

Skimming spatula blade • Лезвие для шпателя алю для гипса  
• Ersatzklinge für Flächenspachtel • Lama pentru spatula

NUMER KATALOGOWY		
040 695	250 mm	1
040 696	450 mm	1
040 697	600 mm	1
040 698	800 mm	1
040 699	1000 mm	1



### SZPACHLA FASADOWA SOFT

Taping knife, stainless steel, soft handle • Шпатель фасадный "SOFT"  
• Fassadenspachtel Soft • Spaclu inox

NUMER KATALOGOWY			
040 180	60 mm	150 mm	1/10
040 181	60 mm	250 mm	1/10
040 182	60 mm	350 mm	1/10
040 183	60 mm	450 mm	1/10
040 184	60 mm	550 mm	1/10



### SZPACHLA FASADOWA SOFT

Taping knife, stainless steel, soft handle • Шпатель фасадный "SOFT"  
• Fassadenspachtel Soft • Spaclu inox

NUMER KATALOGOWY			
040 190	90 mm	150 mm	1/10
040 191	90 mm	250 mm	1/10
040 192	90 mm	350 mm	1/10
040 193	90 mm	450 mm	1/10
040 194	90 mm	550 mm	1/10

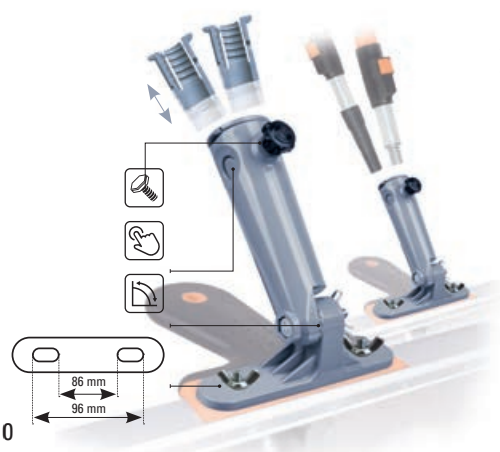

### ADAPTER DO SZPACHLI FASADOWYCH

Taping knife adaptor • Адаптер для шпателя Motive  
• Stielhalter für Flächenspachtel • Suport pentru coadă

NUMER KATALOGOWY	
040 852	1/50



### SZPACHLA NIERDZEWNA SOFT

Taping knife, stainless steel, soft handle • Шпатель нерж. "SOFT"  
• Fassadenspachtel mit Softgriff • Spaclu inox



NUMER KATALOGOWY			
040 164	60 mm	150 mm	1/10/50
040 165	60 mm	250 mm	1/10/50
040 166	60 mm	350 mm	1/10/50
040 167	60 mm	400 mm	1/10/30
040 169	60 mm	600 mm	1/10/30

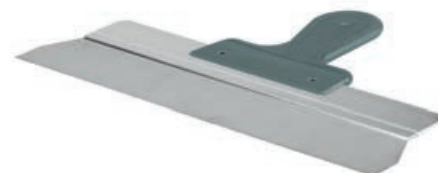

### SZPACHLA NIERDZEWNA FASADOWA

Taping knife, plastic handle • Шпатель фасадный нерж.  
• Fassadenspachtel mit Kunststoffgriff • Spaclu inox



NUMER KATALOGOWY			
040 254	60 mm	150 mm	1/20
040 255	60 mm	250 mm	1/10
040 256	60 mm	350 mm	1/10
040 257	60 mm	450 mm	1/10
040 258	60 mm	600 mm	1/10



### SZPACHLA NIERDZEWNA ZĘBATA

Scraper with teeth • Шпатель нерж. зубчатый • Fassadenspachtel rostfrei  
• Spaclu inox



NUMER KATALOGOWY			
040 201	150 mm	6 mm	1/20
040 202	250 mm	6 mm	1/10
040 203	150 mm	8 mm	1/20
040 204	250 mm	8 mm	1/10



### TACA PVC DO NAKŁADANIA MAS, GŁADZI, FUG

PVC tray • Поднос ПВХ • Putzfalke



NUMER KATALOGOWY			
040 899	330 mm	330 mm	1/3



### SZPACHELKA NIERDZEWNA

Stainless steel putty knife, soft handle • Шпатель нерж. • Rostfrei Spachtel  
• Spaclu inoxidabil



NUMER KATALOGOWY		
040 239	20 mm	1/12/120
040 240	40 mm	1/12/120
040 241	60 mm	1/12/120
040 242	80 mm	1/12/120
040 243	100 mm	1/12/120
040 244	120 mm	1/12/120
040 245	150 mm	1/12/120



### SZPACHELKA WIELOFUNKCYJNA 6 W 1

Multipurpose scraper • Многофункциональный шпатель  
• Multifunktionsspachtel • Spaclu multifunctional



NUMER KATALOGOWY		
040 247	76 mm	1/12/120





**motive**   
Jakość ma znaczenie



**SZPACHELKA DO CZYSZCZENIA WAŁKÓW I PĘDZLI**

Brush and roller cleaner • Малярная расческа для очистки валиков и кистей  
• Pinselkamm • Spaclu pentru curatare trafaleti si pensule

NUMER  
KATALOGOWY



040 246

1/12/120



**motive**   
Jakość ma znaczenie



**SKROBAK LONG**

Bent pole scraper • Скребок с резьбой • Universalschaber • Spaclu pentru razuit cu varf indoit

NUMER  
KATALOGOWY



040 260

75 mm

1/12/120



**motive**   
Jakość ma znaczenie



**SZPACHELKA SILVER MONOLIT**

Stainless steel putty knife • Шпатель нерж. • Rostfrei Spachtel • Şpaclu inoxidabil

NUMER  
KATALOGOWY



040 157

38 mm

1/12/120

040 158

50 mm

1/12/120

040 159

76 mm

1/12/120

040 160

100 mm

1/12/120

040 161

125 mm

1/12/120

040 162

150 mm

1/12/120



**motive**   
Jakość ma znaczenie



**SZPACHELKA NIERDZEWNA Z BITEM**

Stainless steel scraper with bit • Шпатель нержавеющей специальный  
• Şpateľlăpstiņa, nerūsējoša tērauda • Fugenspachtel mit PH2-Bit  
• Şpaclu cu şurubelniţă

NUMER  
KATALOGOWY



040 249

150 mm

1/12/120



**motive**   
Jakość ma znaczenie



**SZPACHELKA GRIP**

Stainless steel putty knife • Шпатель нерж. • Rostfrei Spachtel • Şpaclu inoxidabil

NUMER  
KATALOGOWY



040 170

20 mm

1/12/120

040 171

40 mm

1/12/120

040 172

60 mm

1/12/120

040 173

80 mm

1/12/120

040 174

100 mm

1/12/120

040 175

125 mm

1/12/120

040 176

150 mm

1/12/120

040 177

250 mm

1/12/120



**motive**   
Jakość ma znaczenie



**SZPACHELKA GRIP SKOŚNA**

Stainless steel putty knife • Шпатель нерж. • Rostfrei Spachtel • Şpaclu inoxidabil

NUMER  
KATALOGOWY



040 187

160 mm

1/12/120





#### SZPACHELKA GRIP OSTRA

Stainless steel putty knife • Шпатель нерж. • Rostfrei Spachtel • Şpaclu inoxidabil

NUMER KATALOGOWY	↔	
040 186	160 mm	1/12/120

**motive**  
Jakość ma znaczenie



#### SZPACHELKA GRIP MULTI

Multipurpose scraper • Многофункциональный шпатель  
• Multifunktionsspachtel • Şpaclu multifunctional

NUMER KATALOGOWY	↔	
040 185	76 mm	1/12/120

**motive**  
Jakość ma znaczenie



#### POKROWIEC NA SZPACHLE MONOLIT/GRIP

Putty knife carrying case • Чехол для шпателей • Schoner für Trockenbauspachtel • Husa pentru transport spacluri

NUMER KATALOGOWY	
040 198	1/100

**motive**  
Jakość ma znaczenie



#### SZPACHELKA DO WIADRA EASY-SCOOP

Bucket scoop • Шпатель малярный для ведра/таза, круглый • Eimerschaber  
• Mistris rotunda

NUMER KATALOGOWY	
040 237	1/4

**motive**  
Jakość ma znaczenie



#### SZPACHELKA DO WIADRA EASY-SCOOP - PLASTIKOWA

Bucket scoop • Шпатель малярный для ведра/таза, круглый • Eimerschaber  
• Mistris rotunda

NUMER KATALOGOWY	
040 235	1/4

**motive**  
Jakość ma znaczenie



#### SZPACHELKA NIERDZEWNA

Stainless steel putty knife, plastic handle • Шпатель нерж. • Rostfrei Spachtel mit Kunststoffgriff • Spaclu inox cu maner plastic

NUMER KATALOGOWY	↔	
040 250	40 mm	20
040 251	60 mm	20
040 252	80 mm	20
040 253	100 mm	20





#### SZPACHELKA - SKROBAK

Heavy duty scraper • Скребок с закаленным лезвием • Stoßspachtel  
• Spaclu cu maner lemn

NUMER  
KATALOGOWY



040 259

70 mm

1



#### SZPACHELKA MALARSKA

Putty knife, wooden handle • Шпатель с деревянной ручкой • Malerspachtel  
• Spaclu pentru zugravi

NUMER  
KATALOGOWY



040 230

40 mm

1/12/240

040 231

50 mm

1/12/240

040 232

60 mm

1/12/240

040 233

80 mm

1/12/240

040 234

100 mm

1/12/240



#### SZPACHELKI JAPONKI METALOWE

Metal scrapers 4 pcs set • Шпателя металлические "JAPAN" 4 шт.  
• Japanspachtel-Set aus Stahl • Set spaclu japonez - metal

NUMER  
KATALOGOWY



040 210

5/8/10/12 cm

1/10/120



#### SZPACHELKI JAPONKI PLASTIKOWE

Plastic scrapers set 4 pcs set • Шпателя пластмассовые "JAPAN" 4 шт.  
• Japanspachtel Set - Kunststoff • Set spaclu japonez - plastic

NUMER  
KATALOGOWY



040 211

5/8/10/12 cm

1/10/200



#### KUWETA DO SZPACHLOWANIA

Plastic mud pan • Кювета для шпатлевки • Spachtelkasten Kunststoff  
• Tavita pentru mortar

NUMER  
KATALOGOWY



040 901

350 x 120 x 90 mm

1



#### MIESZADŁO DO GOTOWYCH MAS I GŁADZI

Mortar mixer • Миксер для смесей • Mörtelrührer • Mixer mortar

NUMER  
KATALOGOWY



040 860

HEX

120 mm

1/2

040 861

M14

120 mm

1/2

040 862

M14

135 mm

1/2

040 863

M14

155 mm

1/2

040 864

M14

180 mm

1/2

040 865

M14

200 mm

1/2



#### MIESZADŁO DO ZAPRAW M-14

Paddle mixer M14 • Миксер для смесей M-14 • Mörtelrührer M14  
• Mixer pentru mortar M14

NUMER KATALOGOWY		
040 274	100 mm	1/12
040 276	120 mm	1/12
040 275	135 mm	1/12

**motive**  
Jakość ma znaczenie



#### MIESZADŁO OCYNKOWANE DO MAS PŁYNNYCH I ŻYWIC

Epoxy resins mixing paddle • Миксер для смесей M-14 • Scheiben-Rührstab  
• Mixer pentru rasini

NUMER KATALOGOWY		
040 857	90 mm	1/10

**motive**  
Jakość ma znaczenie



#### MIESZADŁO ŚLIMAKOWE DO ZAPRAW

Concrete mixing paddle • Миксер для смесей "УЛИТКА" • Mörtelstab • Mixer pentru materiale de constructii

NUMER KATALOGOWY		
040 288	90 mm	1/40
040 289	100 mm	1/20
040 856	120 mm	1/10



#### MIESZADŁO DO GIPSU

Mixer paddle for plaster • Миксер для гипса • Gipsrührer  
• Mixer clopot pentru materiale de constructii

NUMER KATALOGOWY		
040 283	80 mm	1/50
040 284	100 mm	1/50



#### MIESZADŁO DO ZAPRAW SDS

SDS mixing paddle • Миксер для смесей SDS • SDS Mörtelrührer  
• Mixer pentru mortar SDS

NUMER KATALOGOWY		
040 278	100 mm	1/6/24
040 279	120 mm	1/6/24

SDS



#### MIESZADŁO DO FARB

Paint mixing paddle • Миксер для красок • Farbrührer • Mixer pentru vopsea

NUMER KATALOGOWY		
040 280	50 mm	1/6/48
040 281	80 mm	1/6/48
040 282	100 mm	1/6/48





#### MIESZADŁO OCYNKOWANE

Galvanized mixing paddle • Миксер для смесей оцинкованный  
• Verzinkt Rührstab • Mixer spirala pentru materiale de constructii

NUMER KATALOGOWY		
040 285	60 mm	1/6
040 286	80 mm	1
040 287	100 mm	1



**motive**  
Jakość ma znaczenie



#### PRZEJŚCIÓWKA M14-SDS

SDS +/- M14 paddle mixer adaptor • Переходник для смесителя SDS +/- M14  
• SDS +/- M14 Rühreradapter • Adaptor SDS+/- M14

NUMER KATALOGOWY		
040 869	M14 → SDS	1/3



**motive**  
Jakość ma znaczenie

#### PRZEDŁUŻKA MIESZADŁA M14

Mixing paddle extension M14 • Удлинитель для смесителя  
• Rührer-Verlängerung M14 • Prelungitor mixer materia M14

NUMER KATALOGOWY		
040 866	10 cm	1/3
040 867	15 cm	1/3
040 868	20 cm	1/3



#### CZERPAK MURARSKI

Bricklayer scoop • Черпак каменщика • Maurerschöpfkelle • Canciocr zidar

NUMER KATALOGOWY		
040 270	163 mm	1/50



**motive**  
Jakość ma znaczenie



#### MISECZKA DO GIPSU

Flexible, plaster mixing bowl • Емкость для гипса • Gipsbecher  
• Vas pentru ipsos

NUMER KATALOGOWY		
040 265	600 ml	1/10/240



#### MISECZKA DO GIPSU

Plaster bowl • Емкость для гипса • Gipsbecher • Vas pentru ipsos

NUMER KATALOGOWY		
040 300	0.5 L	1/20



### POJEMNIK OKRĄGŁY

Round mixing tub • Ведро белое с крышкой • Mörtelkübel  
• Vas pentru constructii

NUMER KATALOGOWY		
040 290	45 L	1/240
040 291	65 L	1/212
040 292	90 L	1/212

### POJEMNIK ELASTYCZNY

Flexible mixing tub • Ведро гибкое • Flexibler Kübel • Cos flexibil cu manere

NUMER KATALOGOWY			
040 997	80 kg	27 L	1/720
040 998	100 kg	42 L	1/600
040 999	120 kg	55 L	1/300

### KAISTRA BUDOWLANA

Rectangular mixing tub • Прямоугольная емкость для раствора  
• Mörtelwanne • Vas pentru constructii

NUMER KATALOGOWY		
040 295	40 L	1/250
040 296	60 L	1/250
040 297	90 L	1/180

### WIADRO BUDOWLANE

Builders bucket • Строительное ведро • Baueimer PE rund  
• Galeata pentru zugravit

NUMER KATALOGOWY		
040 301	12 L	1/1000
040 302	16 L	1/450
040 303	20 L	1/600
040 304	5 L	1

### WIADRO BUDOWLANE NIEBIESKIE

Blue builders bucket • Ведро строительное синее • Baueimer blau  
• Galeata pentru zurgavit

NUMER KATALOGOWY		
040 298	12 L	1
040 992	16 L	1
040 299	20 L	1

### WIADRO OCYNKOWANE

Galvanized bucket • Ведро оцинкованное • Zinkeimer • Galeata zincata

NUMER KATALOGOWY		
040 271	10 L	1/20
040 272	12 L	1/20
040 273	15 L	1/20





**motive**   
Jakość ma znaczenie



**POJEMNIK PLASTIKOWY Z POKRYWĄ**

Plastic bucket with lid • Ведро с крышкой • Eimer mit Deckel  
• Găleată cu capac

NUMER  
KATALOGOWY



040 980

33 L

1/25



**motive**   
Jakość ma znaczenie

**MYJKA DO MIESZADEŁ**

Mixer-Clean Bucket • Мойка для миксеров • Reinigungseimer für Rührer  
• Dispozitiv cu perii pentru curatare mixere pentru material

NUMER  
KATALOGOWY



040 871

1



**WIADRO BIAŁE/POKRYWKA**

White plastic bucket • Ведро белое/крышка • Farbeimer weiß • Galeata alba

NUMER  
KATALOGOWY



040 293

5 L

1/25

040 294

10 L

1/500

040 993

pokrywka/lid

5 L

1/50

040 994

pokrywka/lid

10 L

1/50



**motive**   
Jakość ma znaczenie



**POZIOMICA OPTICAL 6**

Spirit level OPTICAL 6 • Уровень OPTICAL 6 • Wasserwaage OPTICAL 6  
• Nivela OPTICAL 6

NUMER  
KATALOGOWY



040 887

200 cm

1/10



**motive**   
Jakość ma znaczenie



**POZIOMICA HANDY HV**

Spirit level HANDY HV • Уровень HANDY HV • Magnet Wasserwaage Handy HV  
• Nivela cu magnet

NUMER  
KATALOGOWY



040 890

23 cm

1/10



### POZIOMICA SHARKY

Spirit level SHARKY • Уровень SHARKY • Wasserwaage für Fliesenleger Sharky  
• Nivelă specială pentru construcții

NUMER KATALOGOWY	↔	
040 895	60 cm	1/10
040 896	100 cm	1/10

**motive**  
Jakość ma znaczenie



### POZIOMICA HV

Spirit level HV • Уровень HV • Wasserwaage HV • Nivelă profesională

NUMER KATALOGOWY	↔	
040 880	40 cm	1/10/60
040 881	60 cm	1/10
040 882	80 cm	1/10/40
040 883	100 cm	1/10/40
040 884	120 cm	1/10/20
040 885	150 cm	1/10
040 886	200 cm	1/10

**motive**  
Jakość ma znaczenie



### POZIOMICA HV Z MAGNESEM

Spirit level HV with magnet • Уровень HV • Magnet Wasserwaage HV  
• Nivelă cu magnet

NUMER KATALOGOWY	↔	
040 873	40 cm	1/10/60
040 874	60 cm	1/10/60
040 875	80 cm	1/10/40
040 876	100 cm	1/10/40

**motive**  
Jakość ma znaczenie



### POZIOMICA DRYWALL

Spirit level DRYWALL • Уровень DRYWALL • Trockenbau Wasserwaage  
• Nivelă pentru pereti din gips-carton

NUMER KATALOGOWY	↔	
040 891	90 cm	1/10

**motive**  
Jakość ma znaczenie



### POZIOMICA PLUMBER

Spirit level PLUMBER • Уровень PLUMBER • Installateur Wasserwaage  
• Nivelă pentru instalatori

NUMER KATALOGOWY	↔	
040 892	70 cm	1/10

**motive**  
Jakość ma znaczenie





**motive**  
Jakość ma znaczenie



#### POZIOMICA ELECTRIC

Spirit level ELECTRIC • Уровень ELECTRIC • Elektriker-Wasserwaage  
• Nivelă pentru electricieni

NUMER KATALOGOWY	↔	
040 893	48 cm	1/10
040 894	120 cm	1/10



**motive**  
Jakość ma znaczenie



#### POZIOMICA RED

Spirit level RED • Уровень RED • Wasserwaage RED • Nivelă Red

NUMER KATALOGOWY	↔	
040 320	40 cm	1/10
040 321	60 cm	1/10
040 322	80 cm	1/10
040 323	100 cm	1/10
040 324	120 cm	1/10
040 325	150 cm	1/10
040 326	200 cm	1/10



**motive**  
Jakość ma znaczenie

#### POKROWIEC NA POZIOMICIE

Spirit level carrying case • Сумка для уровней • Schoner für Wasserwaage

NUMER KATALOGOWY		
040 349	164 x 81 cm	1/25

\* w sprzedaży pusty pokrowiec, bez poziomicy widocznych na zdjęciu



#### POZIOMICA PROFI MAGNES

Spirit level with magnet • Уровень PROFI MAGNES • Magnet Wasserwaage Profi  
• Nivelă cu magnet

NUMER KATALOGOWY	↔	
040 305	40 cm	1/30
040 315	60 cm	1/30
040 316	80 cm	1/30
040 317	100 cm	1/30
040 318	120 cm	1/30
040 319	150 cm	1/30
040 308	200 cm	1/30



**motive**  
Jakość ma znaczenie

#### ŁATA MURARSKA TRAPEZOWA

Trapezium profile feather edge • Правило трапеция • Trapez Kartätsche  
• Dreptar aluminiu, pentru constructii, tip trapez

NUMER KATALOGOWY	↔	
040 433	100 cm	1/5
040 434	120 cm	1/5
040 435	150 cm	1/5
040 436	180 cm	1/5
040 437	200 cm	1/5
040 438	240 cm	1/5





#### ŁATA MURARSKA PION/POZIOM

Straight-edge aluminium profile V/H with vial • Правило с уровнем  
• Alu-Richtlatte • Dreptar aluminiu, pentru constructii, cu 2 indicatori

NUMER KATALOGOWY	↔	
040 430	150 cm	1/5
040 431	200 cm	1/5
040 432	250 cm	1/5

#### ŁATA MURARSKA TRAPEZOWA

Trapezium profile feather edge • Правило трапеция • Trapez Kartätsche  
• Dreptar aluminiu, pentru constructii

NUMER KATALOGOWY	↔	
040 608	100 cm	1/10
040 609	120 cm	1/10
040 610	150 cm	1/10
040 611	180 cm	1/10
040 612	200 cm	1/10
040 613	240 cm	1/10
040 614	300 cm	1/10

#### ŁATA MURARSKA PION/POZIOM

Straight-edge aluminium profile V/H with vial • Правило с уровнем  
• Alu-Richtlatte • Dreptar aluminiu, pentru constructii, cu 2 indicatori

NUMER KATALOGOWY	↔	
040 600	150 cm	1/10
040 601	200 cm	1/10
040 602	250 cm	1/10

#### ŁATA MURARSKA TYP H

H profile feather edge • Правило тип "h" • H-Profil-Kartätsche  
• Dreptar aluminiu, pentru constructii, tip h

NUMER KATALOGOWY	↔	
040 618	150 cm	1/5
040 619	200 cm	1/5
040 620	250 cm	1/5

#### ŁATA MURARSKA Z UCHWYTEM

Aluminium profile V/H with handle • Правило с ручками • Alu Richtlatte mit 2 Handgriffe • Dreptar aluminiu, pentru constructii, cu 2 indicatori

NUMER KATALOGOWY	↔	
040 615	150 cm	1/10
040 616	200 cm	1/10
040 617	250 cm	1/10

**motive**   
Jakość ma znaczenie

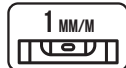

**motive**   
Jakość ma znaczenie



**motive**   
Jakość ma znaczenie

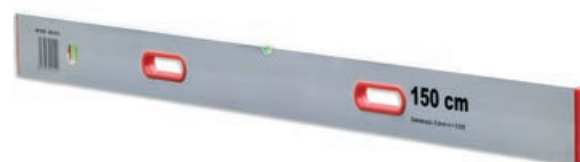



**motive**   
Jakość ma znaczenie



**KĄTOWNICA Z POPRZECZKĄ**

L square • Строительный уголок • Bauwinkel mit Strebe • Echer pentru constructie

NUMER  
KATALOGOWY



040 811

100 x 50 cm

1/5

040 812

120 x 60 cm

1/5



PVC

**POZIOMICA WODNA Z WĘŻEM**

Water level • Уровень водный со шлангом • Schlauchwasserwaage  
• Furtun de nivel

NUMER  
KATALOGOWY



040 307

20 m

1/10



**KĄTOWNIK METALOWY**

Metal angle ruler • Угломер металлический • Bauwinkel • Echer tamplarie

NUMER  
KATALOGOWY



040 348

600 mm x 400 mm

1/6/36



**motive**   
Jakość ma znaczenie



**NOŻYCE DO CIĘCIA BLACHY**

Aviation Snips • Листовые ножницы • Blechschere- links  
• Foarfeca de tabla, stanga

NUMER  
KATALOGOWY



040 350

LEWE / LEFT

1/6/60



**motive**   
Jakość ma znaczenie



**NOŻYCE DO CIĘCIA BLACHY**

Aviation Snips • Листовые ножницы • Blechschere- rechts  
• Foarfeca de tabla, dreapta

NUMER  
KATALOGOWY



040 351

PRAWY / RIGHT

1/6/60



### NOŻYCE DO CIĘCIA BLACHY

Aviation Snips • Листовые ножницы • Blechschere- gerade  
• Foarfeca de tabla

**motive**  
Jakość ma znaczenie



NUMER  
KATALOGOWY



040 352

PROSTE / STRAIGHT

1/6/60

### PRZYRZĄD DO WIĄZANIA PRĘTÓW

Reinforcement rod tying tool • Инструмент для связывания арматуры  
• Drillkurbel • Unealta pentru legat otel beton

**motive**  
Jakość ma znaczenie



NUMER  
KATALOGOWY



040 368

1/12/48

### ŁAPKA DO GWOŹDZI

Crowbar • Гвоздодер • Brechstange • Ranga tip levier



NUMER  
KATALOGOWY



040 358

19 mm

500 mm

1/20

040 359

19 mm

700 mm

1/20

### PRZECINAK ZE STALI STOPOWEJ

Cold chisel with hand guard • Зубило закаленное • Flachmeissel mit  
Handschutz • Dalta pentru constructii, cu protectie



NUMER  
KATALOGOWY



040 360

300 mm

1/6

040 361

400 mm

1/6

### MŁOTEK CIESIELSKI MONOLIT

Roofing one-piece hammer, MONOLIT • Плотничий молоток MONOLIT  
• Latthammer Monolit • Ciocan dulgheri

**motive**  
Jakość ma znaczenie



NUMER  
KATALOGOWY



040 492

0.6 kg

1/3/6/24



**motive**  
Jakość ma znaczenie



#### MŁOTEK CIESIELSKI

Roofing, fiberglass handle hammer • Плотничный молоток  
• Latthammer • Ciocan dulgheri

NUMER  
KATALOGOWY

kg



040 491

0.6 kg

1/3/24



**motive**  
Jakość ma znaczenie



#### MŁOTEK ŚLUSARKI

Machinist, fiberglass handle hammer • Слесарный молоток  
• Schlosserhammer • Ciocan lacatus coada fibra

NUMER  
KATALOGOWY

kg



040 481

0.1 kg

1/3/6/24

040 482

0.2 kg

1/3/6/24

040 483

0.3 kg

1/3/6/48

040 484

0.4 kg

1/3/6/36

040 485

0.5 kg

1/3/6/36

040 486

0.6 kg

1/3/6/36

040 487

0.8 kg

1/3/6/24

040 488

1 kg

1/3/6/24

040 489

1.5 kg

1/3/12

040 490

2 kg

1/3/6/12



#### MŁOTEK CIESIELSKI

Roofing hammer • Плотничный молоток • Latthammer • Ciocan dulgheri

NUMER  
KATALOGOWY

kg



040 380

0.6 kg

1/6/24



**motive**  
Jakość ma znaczenie



#### MŁOTEK STOLARSKI

Claw hammer • Столярный молоток • Klauenhammer • Ciocan tamplarie

NUMER  
KATALOGOWY

kg



040 496

0.6 kg

1/6/24



#### MŁOTEK ŚLUSARSKI

Machinist hammer, wooden handle • Слесарный молоток  
• Schlosserhammer • Ciocan pentru lacatus

NUMER  
KATALOGOWY

kg



040 370

0.3 kg

1/6/60

040 374

0.4 kg

1/6/48

040 371

0.5 kg

1/6/36

040 375

0.8 kg

1/6/24

040 372

1.0 kg

1/6/24

040 373

1.5 kg

1/6/12

040 376

2.0 kg

1/6/12

040 377

3.0 kg

1/6



**MŁOTEK MURARSKI MONOLIT**

Masonry one-piece hammer MONOLIT • Молоток каменщика MONOLIT  
 • Maurerhammer • Ciocan zidarie

NUMER  
KATALOGOWY

040 495



0.5 kg



1/3/6/24

**motive**  
 Jakość ma znaczenie



**MŁOTEK STOLARSKI MONOLIT**

Claw one-piece hammer MONOLIT • Столярный молоток MONOLIT  
 • Klauenhammer Monolit • Ciocan tamplarie Monolit

NUMER  
KATALOGOWY

040 497



0.5 kg



1/3/6/24

**motive**  
 Jakość ma znaczenie



**MŁOTEK GUMOWY UCHWYT METALOWY**

Rubber head hammer, steel tube handle, rubber grip • Молоток резиновый  
 с металлической ручкой • Gummihammer mit Stahlrohrstiel und Gummigriff  
 • Ciocan cauciuc

NUMER  
KATALOGOWY

040 390



0.45 kg



1/6/36



**MŁOTEK MURARSKI**

Masonry fiberglass handle hammer • Молоток каменщика • Maurerhammer  
 • Ciocan zidarie

NUMER  
KATALOGOWY

040 494



0.6 kg



1/6/24

**motive**  
 Jakość ma znaczenie



**MŁOTEK MURARSKI TYP BERLIŃSKI**

Masonry hammer, wooden handle • Молоток каменщика тип "берлинский"  
 • Maurerhammer berliner form • Ciocan zidarie

NUMER  
KATALOGOWY

040 385



0.7 kg



1/5



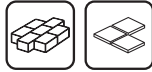

#### MŁOTEK GUMOWY UCHWYT DREWNIANY

Rubber head hammer, wooden handle • Молоток резиновый с деревянной ручкой • Gummihammer schwarz • Ciocan cauciuc negru maner lemn

NUMER KATALOGOWY	kg	
040 393	0.45 kg	1/6/24
040 391	0.6 kg	1/6/24
040 392	0.9 kg	1/6/24

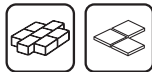

#### MŁOTEK GUMOWY BIAŁY

White rubber head hammer • Молоток резиновый белый • Gummihammer weiß • Ciocan cauciuc, alb

NUMER KATALOGOWY	kg	
040 394	0.5 kg	1/6/24
040 395	1 kg	1/6/24



#### TRZON DO MŁOTKA MURARSKIEGO

Shaft to hammer • Черенок для молотка • Maurerhammerstiel rheinische Form • Coada pentru ciocan

NUMER KATALOGOWY	
040 464	1/10



#### TRZON DO KILOFA

Shaft to pickaxe • Черенок для кирки • Stiel für Pickel • Coada pentru tarnacop

NUMER KATALOGOWY	kg	
040 480	2.5 kg	1/10



#### TRZON DO MŁOTKA

Shaft to hammer • Черенок для молотка • Hammerstiel • Coada pentru ciocan lacatus

NUMER KATALOGOWY		
040 450	28 cm	1/50
040 451	32 cm	1/50
040 452	36 cm	1/50
040 453	40 cm	1/50
040 454	50 cm	1/50
040 455	60 cm	1/10
040 456	70 cm	1/10
040 457	80 cm	1/10
040 458	90 cm	1/10

# PĘDZLE I SZCZOTKI

КИСТИ И ЩЁТКИ • PAINTBRUSHES & BRUSHES

• PINSEL, BESEN • PENSULE, BIDINELE, MATURI



# NOWOŚĆ

PRODUKT  
POLSKI

PRODUKT CHRONIONY PATENTEM PAT. 223073

# ZDRAPER®

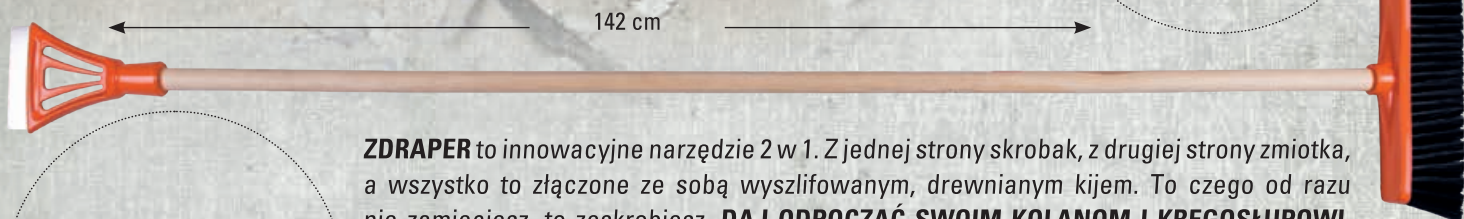

**ZDRAPER** to innowacyjne narzędzie 2 w 1. Z jednej strony skrobak, z drugiej strony zmiotka, a wszystko to połączone ze sobą wyszlifowanym, drewnianym kijem. To czego od razu nie zamiecioniesz, to zeszkobiesz. **DAJ ODPOCZAĆ SWOIM KOLANOM I KRĘGOSŁUPOWI. PRACUJ SZYBCIEJ, BEZ ZBĘDNEGO WYSIŁKU!**

**Jedno narzędzie, a tak wszechstronne.** Przy pomocy **ZDRAPER**A:

- zamiecioniesz i posprzątasz
- przygotujesz podłoże do kafelkowania, tapetowania, układania paneli, klejenia itp.
- zdejmiesz stare tapety ze ściany
- usuniesz chwasty ze szczelin w kostce brukowej.



Z jednej strony wytrzymały skrobak z ostrzem ze stali nierdzewnej o grubości 0,7 mm, odpowiedni do usuwania zaschniętych plam po farbie, kleju, tynku, żywicach lub innych zabrudzeniach powstałych w trakcie remontu.



Z drugiej strony zmiotka wykonana z tworzywa, ze sztucznym i gęstym włosiem do łatwego zamiatania nie tylko kurzu, ale również drobnego gruzu i odprysków po zeschniętych farbach.

Długi kij, który w tym przypadku działa również jak trzonek, zapewnia odpowiedni zasięg i nacisk na podłoże, dzięki czemu bez trudu zeszkobiesz plamę lub brud, a potem dokładnie zamiecioniesz.

**ZDRAPER®**  
Nr kat. 040 197







# V-PRO

## PROFESJONALNE PĘDZLE MALARSKIE

Seria nowoczesnych pędzli w pełnej gamie rozmiarowej gwarantujących najlepszy i najbardziej estetyczny efekt podczas malowania. Właściwie dopracowane włosie oraz wysokiej jakości wykończenie pędzli zadowolą nawet najbardziej wymagających użytkowników. Pędzle przeznaczone są do malowania wszystkimi rodzajami farb.



Ścięte pod kątem włosie pomaga w precyzyjnym, końcowym malowaniu farbami wykończeniowymi. Idealne do malowania odcień kolorów.

Uniwersalne pędzle przydatne podczas większości prac malarskich. Do malowania drewna, metalu, ale również niedużych powierzchni ścian.



**PĘDZEL V-PRO AS**  
Angled sash paintbrush AS  
• Beschneidepinsel AS

NUMER KATALOGOWY			
050 571	66 mm	1,5"	1/12
050 572	70 mm	2"	1/12
050 573	80 mm	2,5"	1/12
050 574	85 mm	3"	1/12

**PĘDZEL V-PRO SC**  
Paint brush SC • Malerpinsel SC

NUMER KATALOGOWY			
050 575	56 mm	1"	1/12
050 576	66 mm	1,5"	1/12
050 577	70 mm	2"	1/12
050 578	76 mm	2,5"	1/12
050 579	85 mm	3"	1/12
050 580	90 mm	3,5"	1/12



Lekka, wyprofilowana rączka wykonana ze szlifowanego, bukowego drewna

Matowa, metalowa i nierdzewna skuwka z wybitym na niej rozmiarem określającym szerokość pędzla

Gęste i hartowane włosie wykonane ze specjalistycznych okrągłych i zwężających się włókien

Użyty do osadzenia włosia klej epoksydowy zapobiega wypadaniu włókien podczas malowania



**PĘDZEL V-PRO HANDY AS**  
Paint brush Handy AS • Malerpinsel Handy AS

NUMER KATALOGOWY			
050 565	70 mm	2"	1/12



**PĘDZLE V-PRO - DWUPAK**  
Paint brush Handy AS • Malerpinsel Handy AS

NUMER KATALOGOWY			
050 582	70 mm	1"	1/12





**motive**   
Jakość ma znaczenie

**PĘDZEL "WOOD"**

Paintbrush „wood” • КИСТЬ WOOD • Flachpinsel Wood • Pensula plata Wood

NUMER KATALOGOWY			
050 060	51 mm	30 mm	1/12
050 061	58 mm	40 mm	1/12
050 062	60 mm	50 mm	1/12
050 063	65 mm	60 mm	1/12
050 064	70 mm	70 mm	1/12



**motive**   
Jakość ma znaczenie

**PĘDZEL DO AKRYLI**

Flat nylon paintbrush for acrylic paints • Кисть для акриловых красок • Acrylpinsel • Pensula pentru vopsea pe baza de apa

NUMER KATALOGOWY			
050 550	56 mm	1"	1/12/600
050 551	57 mm	1,5"	1/12/600
050 552	58 mm	2"	1/12/360
050 553	71 mm	2,5"	1/12/300
050 554	70 mm	3"	1/12/240
050 555	80 mm	4"	1/12/120



**motive**   
Jakość ma znaczenie

**PĘDZEL RED**

Paintbrush RED, natural bristle, plastic handle • Кисть RED • Flachpinsel Red • Pensula Red

NUMER KATALOGOWY			
050 070	45 mm	1"	12/360
050 071	53 mm	1.5"	12/360
050 072	56 mm	2"	12/300
050 073	64 mm	2.5"	12/240
050 074	67 mm	3"	12/120
050 075	80 mm	4"	12



**PĘDZEL ANGIELSKI PROFI**



Paintbrush, natural bristle, wooden, varnished handle • Кисть английская профи • Flachpinsel, lackierter Holzstiel • Pensula profi

NUMER KATALOGOWY			
050 510	45 mm	1"	1/12
050 511	46 mm	1.5"	1/12
050 512	47 mm	2"	1/12
050 513	52 mm	2.5"	1/12
050 514	50 mm	3"	1/12
050 515	56 mm	3.5"	1/12
050 516	58 mm	4"	1/12



### PEŹZEL ANGIELSKI PROFI PLASTIK



Paintbrush, natural bristle, plastic, varnished handle • Кисть английская профи пластик • Flachpinsel, lackierter Kunststoff-Stiel • Pensula maner PVC

NUMER KATALOGOWY			
050 101	47 mm	1"	12/1200
050 102	47 mm	1.5"	12/720
050 103	51 mm	2"	12/360
050 104	52 mm	2.5"	12/360
050 105	50 mm	3"	12/240
050 106	60 mm	3.5"	12/240
050 107	60 mm	4"	12/180



### PEŹZEL ANGIELSKI PLASTIK



Paintbrush, natural bristle, plastic handle • Кисть английская пластик • Flachpinsel, helle China-Borste • Pensula maner PVC

NUMER KATALOGOWY			
050 080	45 mm	25 mm	12/1200
050 081	47 mm	36 mm	12/600
050 082	51 mm	50 mm	12/480
050 083	51 mm	63 mm	12/360
050 084	51 mm	76 mm	12/240
050 087	58 mm	90 mm	12/240
050 085	57 mm	102 mm	12/240



### PEŹZEL ANGIELSKI



Paintbrush, natural bristle, wooden handle • Кисть английская • Flachpinsel • Pensula plata

NUMER KATALOGOWY			
050 110	46 mm	25 mm	12/720
050 111	46 mm	36 mm	12/480
050 112	51 mm	50 mm	12/360
050 113	51 mm	63 mm	12/360
050 114	50 mm	76 mm	12/240
050 115	58 mm	90 mm	12/240
050 116	58 mm	102 mm	12/240



### PEŹZEL PÓLANGIELSKI

Paintbrush, natural bristle, flat wooden handle • Кисть полуанглийская • Flachpinsel • Pensula plata

NUMER KATALOGOWY			
050 090	38 mm	25 mm	12/1200
050 091	42 mm	36 mm	12/720
050 092	43 mm	50 mm	12/480
050 093	44 mm	63 mm	12/360
050 094	45 mm	76 mm	12/360
050 096	43 mm	90 mm	12/240
050 095	52 mm	102 mm	12/240





### PĘDZEL PŁASKI DO EMULSJI

Flat paintbrush for emulsion paints • Кисть плоская для эмульсий  
• Flachpinsel für Dispersionsfarbe • Pensula plata

NUMER KATALOGOWY			
050 400	45 mm	1"	12
050 401	46 mm	1.5"	12
050 402	52 mm	2"	12
050 403	51 mm	2.5"	12
050 404	51 mm	3"	12
050 405	52 mm	4"	12



### PĘDZEL PŁASKI NYLON DO AKRYLI

Flat nylon paintbrush for acrylic paints • Кисть плоская «nylon» для акриловых красок • Acrylpinsel Nylon • Pensula pentru vopsea pe baza de apa

NUMER KATALOGOWY			
050 200	50 mm	1"	12
050 201	58 mm	1.5"	12
050 202	58 mm	2"	12
050 203	65 mm	2.5"	12
050 204	65 mm	3"	12
050 206	77 mm	3,5"	12
050 205	77 mm	4"	12



### PĘDZEL OKRĄGŁY

Round paintbrush • Кисть круглая • Ringnpinsel • Pensula rotunda

NUMER KATALOGOWY			
050 130	34 mm	20 mm	12/1200
050 131	34 mm	25 mm	12/960
050 132	36 mm	30 mm	12/720
050 133	42 mm	35 mm	12/576
050 134	42 mm	40 mm	12/408
050 135	41 mm	45 mm	12/336
050 136	40 mm	50 mm	12/288
050 137	46 mm	55 mm	12/240
050 138	47 mm	60 mm	12/192
050 139	48 mm	70 mm	12/144

### PĘDZEL DO PASKÓW

Line flat brush • Кисть для полосок • Strichzieher • Pensula de linii

NUMER KATALOGOWY			
050 128	9 mm	2 mm	12
050 129	11 mm	4 mm	12
050 145	12 mm	6 mm	12
050 146	15 mm	8 mm	12
050 147	15 mm	10 mm	12
050 148	17 mm	12 mm	12
050 144	ZESTAW/SET	2,4,6 mm	1/12/240
050 149	ZESTAW/SET	8,10,12 mm	1/24/240



**motive**  
Jakość ma znaczenie





**PEŁDZEL V-PRO DO PASKÓW**

Pointed sash brush • Schräg-Strichzieher • Кисть круглая  
• Pensula de linii

NUMER KATALOGOWY			
050 590	25 mm	6 mm	1/24/144
050 591	30 mm	12 mm	1/24/144
050 592	33 mm	18 mm	1/24/144



**PEŁDZEL V-PRO OKRĄGŁY**

Lining fitch brush • Кисть для полосок • Sprossenpinsel • Pensula rotunda

NUMER KATALOGOWY			
050 595	52 mm	12 mm	12/72
050 596	52 mm	15 mm	12/72
050 597	53 mm	21 mm	12/72



**PEŁDZEL KALORYFEROWY V-PRO**

Radiator paintbrush V-PRO • Радиаторная кисть V-PRO  
• Heizkörperpinsel V-PRO • Pensula pentru calorifer V-PRO

NUMER KATALOGOWY		
050 584	25 mm	10
050 585	35 mm	10
050 587	50 mm	12
050 588	70 mm	12



**PEŁDZEL KALORYFEROWY RED**

Radiator paintbrush RED • Радиаторная кисть RED • Heizkörperpinsel Red  
• Pensula pentru calorifer

NUMER KATALOGOWY			
050 190	46 mm	35 mm	12
050 191	55 mm	50 mm	12
050 192	54 mm	60 mm	6
050 193	56 mm	70 mm	6





#### PĘDZEL KALORYFEROWY

Radiator paintbrush • Радиаторная кисть • Heizkörperpinsel  
• Pensula pentru calorifer

NUMER KATALOGOWY			
050 120	48 mm	25 mm	12/480
050 121	48 mm	36 mm	12/360
050 122	48 mm	50 mm	12/300
050 123	48 mm	63 mm	12/240



**motive**  
Jakość ma znaczenie



#### PĘDZEL DO DEKORACJI

Mottler brush • Кисть для декора • Schleifmodler • Pensula pentru efecte decorative, tip spalter

NUMER KATALOGOWY			
050 186	48 mm	120 mm	1/12



#### SZCZOTKA DO TAPETOWANIA

Paperhanging brush • Щетка для наклеивания обоев • Tapezierbürste • Pensula pentru tapet

NUMER KATALOGOWY		
070 305	300 mm	1/40/1600



**motive**  
Jakość ma znaczenie



#### TAPETÓWKA

Block brush • Минимакловица • Flächenstreicher, helle Borste  
• Bidinea pentru tapet

NUMER KATALOGOWY				
050 040	28 mm	58 mm	110 mm	1/5
050 041	28 mm	64 mm	130 mm	1/6
050 042	38 mm	68 mm	140 mm	1/6
050 043	49 mm	70 mm	150 mm	1/5



### TAPETÓWKA

Block brush • Минимакловица • Flächenstreicher • Bidinea pentru tapet



NUMER KATALOGOWY					
050 150	22 mm	40 mm	70 mm	1/12/120	
050 151	27 mm	45 mm	90 mm	1/12/120	
050 152	27 mm	47 mm	110 mm	1/12/120	
050 153	27 mm	45 mm	130 mm	1/12/120	
050 154	31 mm	50 mm	140 mm	1/6/60	
050 155	40 mm	50 mm	150 mm	1/6/60	



### ŁAWKOWIEC

Block brush • Макловица • Malerbürste • Bidinea pentru zugravit



NUMER KATALOGOWY					
050 160	55 mm	67 mm	170 mm	1/2/12	
050 161	65 mm	67 mm	180 mm	1/2/12	
050 162	74 mm	70 mm	190 mm	1/2/12	



### CHLAPAK

Water splash brush • Кисть-брызгатель • Deckenbürste • Bidinea pentru grunduri



NUMER KATALOGOWY				
050 165	85 mm	65 mm	200 mm	1/50



### CHLAPAK NYLON

Pasting brush • Кисть-брызгатель NYLON • Deckenbürste, Polypropylen-Borste • Bidinea pentru grunduri Nylon



NUMER KATALOGOWY				
050 163	65 mm	170 mm	1/40	



### SMOŁOWIEC SZARY

Tar brush grey • Макловица "серая" для нанесения холодных битумных масс • Teerbürste- grau • Bidinea pentru bituminoasa gri



NUMER KATALOGOWY				
050 170	70 mm	200 mm	1/60	





#### SMOŁOWIEC SZARY KOMPLET

Tar brush with pole • Макловица "серая" для нанесения холодных битумных масс, комплект • Teerbürste mit Stiel • Bidinea pentru bituminoasa gri

NUMER  
KATALOGOWY

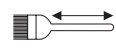

050 159

70 mm

20 cm

120 cm

1/40



#### KIJ DO SMOŁOWCA

Pole for tar brush • Черенок для "серой" или "белой" макловицы • Holzstiel für Teerbürste • Coada pentru bidinea bituminoasa

NUMER  
KATALOGOWY



050 180

120 cm

1/25



#### ULICÓWKA

Street broom • Уличная щетка • Straßenbesen • Mătură stradă

NUMER  
KATALOGOWY



050 175

75 mm

300 mm

1/10

050 176

85 mm

400 mm

1/10

050 177

85 mm

500 mm

1/10

050 178

75 mm

600 mm

1/10

050 179

80 mm

800 mm

1/10



#### KIJ DO ULICÓWKI

Pole for street broom • Черенок для уличной щетки • Besenstiel mit konus • Coada pentru mătură

NUMER  
KATALOGOWY



050 181

24 mm

140 cm

1/25

050 142

24 mm

180 cm

1/25

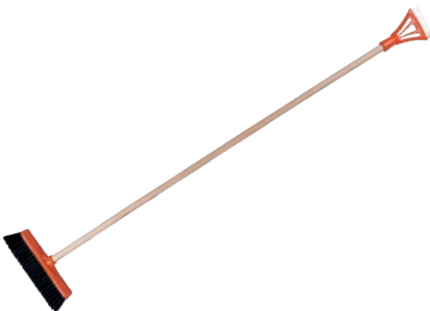

**motive**  
Jakość ma znaczenie

**ZDRAPER**



#### ZDRAPER

Street broom with metal scraper ZDRAPER • Уличная щетка с ледорубом ZDRAPER • Besen mit Schaber • Mătură stradă ZDRAPER

NUMER  
KATALOGOWY



040 197

142 cm

1/10





### ULICÓWKA ZE SKROBAKIEM METALOWYM

Street broom with metal scraper • Уличная щетка с ледорубом  
• Straßenbesen mit Schabeblech • Mătură stradă

NUMER KATALOGOWY			
050 194	75 mm	440 mm	1/10

### KIJ DO ULICÓWKI ZE SKROBAKIEM

Pole for street broom with metal scraper • Черенок для уличной щетки с ледорубом • Besenstiel • Coadă pentru mătură

NUMER KATALOGOWY			
050 195	28 mm	140 cm	1/25

### SZCZOTKA DO KOSTKI BRUKOWEJ ZE SKROBAKIEM

Block paving brush with spike • Проволочная щетка для брусчатки со скребком • Pflasterstein-Besen • Perie pentru curatarea pavajului

NUMER KATALOGOWY	
050 196	1/10

### ZAMIATACZ PRZEMYSŁOWY

Professional industrial broom • Метла "промышленная"  
• Industriebesen • Mătură industrială

NUMER KATALOGOWY			
050 600	65 mm	430 mm	1/10
050 601	65 mm	630 mm	1/10

### ZAMIATACZ

Indoor broom head • Метла • Zimmerbesen • Matura interior

NUMER KATALOGOWY			
050 167	65 mm	350 mm	1/25

**motive**   
Jakość ma znaczenie





#### ZAMIATACZ PROFI

Indoor broom head Profi • Метла PROFИ • Zimmerbesen Profi • Mătură profi

NUMER  
KATALOGOWY



050 197

65 mm

320 mm

1/6



#### MIOTŁA

Nylon broom head • Метла • Allzweckbesen • Mătură

NUMER  
KATALOGOWY



050 168

140 mm

350 mm

1/25



#### MIOTŁA NYLON

Nylon broom head • Метла "NYLON" • Allzweckbesen • Mătură Nylon

NUMER  
KATALOGOWY



050 169

240 mm

1/25



#### MIOTŁA SKOŚNA

Slanting broom • Метла угловая • Allzweckbesen mit Stiel • Mătură oblică

NUMER  
KATALOGOWY



050 173

270 mm

300 mm

150 cm

1/25



#### MIOTŁA SORGO

Corn broom • Broom „sorgo” style • Метла „Sorgo” • Reisstrohbesen • Mătură Sorgo

NUMER  
KATALOGOWY



050 172

450 mm

360 mm

140 cm

1/10



**KIJ DO MIOTŁY I SMOŁOWCA GWINTOWANY**

Threaded wooden pole • Черенок с резьбой • Besenstiel mit Gewinde  
• Coadă pentru bidinea bituminoasă

NUMER KATALOGOWY		
050 164	120 cm	1/25
050 141	180 cm	1/25

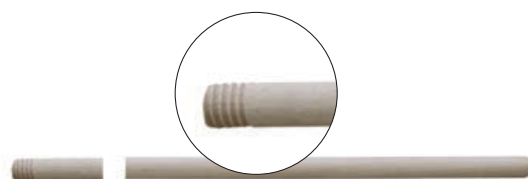

**ZMIOTKA**

Sweeper • Метелка • Handfeger • Matura

NUMER KATALOGOWY		
050 166	170 mm	1/64



**ZMIOTKA KOKOS**

Hand brush coconut • Щетка КОКОС • Kokos-Handfeger • Matura de cocos

NUMER KATALOGOWY			
050 157	70 mm	160 mm	1



**ZMIOTKA PROFI**

Sweeper PROFI • Метелка PROFI • Handfeger Profi • Matura Profi

NUMER KATALOGOWY			
050 156	58 mm	150 mm	1/6/90



**SZUFELKA ZE ZMIOTKĄ**

Dustpan and sweeper set • Совок со щеткой • Schaufel mit Handfeger  
• Matura + faras

NUMER KATALOGOWY	
050 174	1/24



**SZUFELKA METALOWA**

Metal dustpan • Соквoк металлический • Handschaufel • Faras metalic

NUMER  
KATALOGOWY

39 cm



21 cm



20 cm



1/5

**WYCIERACZKA SZCZOTKOWA**Shoe scrubber doormat • Придверный половик • Fußmatte mit Bürsten  
• Covoras de intrare cu periiNUMER  
KATALOGOWY

58 cm



37 cm



1

**WYCIERACZKA SZCZOTKOWA BOCZNA**Shoe brush scrubber • Приспособление для чистки обуви • Schuhabtreter  
• Perie pentru curatarea incaltaminteiNUMER  
KATALOGOWY

36 cm



32 cm



1

# ARTYKUŁY ŚCIERNE

АБРАЗИВЫ • ABRASIVE ARTICLES

• SCHLEIFZUBEHÖR • ABRAZIVE



# PŁÓTNA ŚCIERNE

## CAŁA GAMA DOSTĘPNA JUŻ W SPRZEDAŻY

Wprowadziliśmy do oferty nowe płótna ściernie. Elastyczny podkład arkusza i wytrzymały, pełny nasyp ścierny to najważniejsze cechy charakteryzujące nasze płótna. Z powodzeniem nadają się one do ręcznej obróbki szlifierskiej drewna, metali i tworzyw sztucznych. Znajdą zastosowanie w profesjonalnej, jak również w amatorskiej pracy. Arkusze pakowane są po 50 szt. w estetycznym i oznakowanym kartonie.

**NOWOŚĆ**  
W NASZEJ OFERCIE



W OFERCIE REGAŁY  
DO SPRZEDAŻY  
PŁÓCIEN (STR. 267)



**PAPIER ŚCIERNY W ROLCE 50M**

Sandpaper roll • Наждачная бумага • Schleifpapier Rolle für Holz und Farben • Rola panza abraziva



NUMER KATALOGOWY				
060 300	115 mm	50 m	40	1
060 301	115 mm	50 m	60	1
060 302	115 mm	50 m	80	1
060 303	115 mm	50 m	100	1
060 304	115 mm	50 m	120	1
060 305	115 mm	50 m	150	1
060 306	115 mm	50 m	180	1
060 307	115 mm	50 m	220	1
060 308	115 mm	50 m	240	1
060 309	115 mm	50 m	320	1



**PAPIER ŚCIERNY W ROLCE 50M**

Sandpaper roll • Наждачная бумага • Schleifpapier Rolle für Holz und Farben • Rola panza abraziva

NUMER KATALOGOWY				
060 010	115 mm	50 m	40	1
060 011	115 mm	50 m	60	1
060 012	115 mm	50 m	80	1
060 013	115 mm	50 m	100	1
060 014	115 mm	50 m	120	1
060 015	115 mm	50 m	150	1
060 016	115 mm	50 m	180	1
060 017	115 mm	50 m	220	1
060 018	115 mm	50 m	240	1
060 019	115 mm	50 m	320	1



**PAPIER ŚCIERNY W ROLCE 5M**

Sandpaper roll • Наждачная бумага • Schleifpapier Rolle für Holz und Farben • Rola panza abraziva

NUMER KATALOGOWY				
060 041	115 mm	5 m	40	1
060 042	115 mm	5 m	60	1
060 043	115 mm	5 m	80	1
060 044	115 mm	5 m	100	1
060 045	115 mm	5 m	120	1
060 046	115 mm	5 m	150	1
060 047	115 mm	5 m	180	1
060 048	115 mm	5 m	220	1



**PLÓTNO ŚCIERNE**

Sanding cloth • Наждачное полотно • Schleifpapier • Coala abraziva



NUMER KATALOGOWY			
060 230	230 mm x 280 mm	40	50
060 231	230 mm x 280 mm	60	50
060 232	230 mm x 280 mm	80	50
060 233	230 mm x 280 mm	100	50
060 234	230 mm x 280 mm	120	50
060 235	230 mm x 280 mm	150	50
060 236	230 mm x 280 mm	180	50
060 238	230 mm x 280 mm	220	50
060 239	230 mm x 280 mm	240	50



**PLÓTNO ŚCIERNE KLINGSPOR**Sanding cloth "KLINGSPOR" • Наждачное полотно "KLINGSPOR"  
• Schleifpapier KLINGSPOR • Coala abraziva Klingspor

NUMER KATALOGOWY			
060 030	230 mm x 280 mm	40	50
060 031	230 mm x 280 mm	60	50
060 032	230 mm x 280 mm	80	50
060 033	230 mm x 280 mm	100	50
060 034	230 mm x 280 mm	120	50
060 035	230 mm x 280 mm	150	50
060 036	230 mm x 280 mm	180	50
060 037	230 mm x 280 mm	220	50
060 038	230 mm x 280 mm	240	50

**ZACIERACZKA**Hand sander • Ручка для абразивной сетки • Handschleifer  
• Suport smirghel cu surub fixare

NUMER KATALOGOWY		
060 179	100 mm x 230 mm	1/10/50

**ZACIERACZKA**Hand sander • Ручка для абразивной сетки • Handschleifer  
• Suport smirghel cu surub fixare

NUMER KATALOGOWY		
060 180	100 mm x 225 mm	1/10/50

**DYSK SZLIFIERSKI Z RZEPEM**Sanding pad for grinder • Шлифовальный диск с липучкой • Klett Schleifteller  
• Suport pt. disc abr. arici

NUMER KATALOGOWY		
060 050	125 mm	1/10/100

**DYSK DO WIERTAREK Z RZEPEM**Sanding pad for drill • Шлифовальный диск к дрели с липучкой  
• Klett Schleifteller für Bohrmaschine • Suport pt. disc velcro

NUMER KATALOGOWY		
060 051	125 mm	1/10/100





**KRAŻEK ŚCIERNY (RZEP) 10 SZT.**

Velcro sanding disc (10 pcs) • Наждачное полотно круглое с липучкой (10 шт.) • Klett Schleifscheiben (10 Stück) • Flansa abraziva pentru masina de slefuit, autoadeziva

NUMER KATALOGOWY			
060 053	125 mm	36	1/10/100
060 054	125 mm	40	1/10/100
060 055	125 mm	60	1/10/100
060 056	125 mm	80	1/10/100
060 057	125 mm	100	1/10/100
060 058	125 mm	120	1/10/100
060 059	125 mm	150	1/10/100
060 060	125 mm	180	1/10/100
060 061	125 mm	220	1/10/100

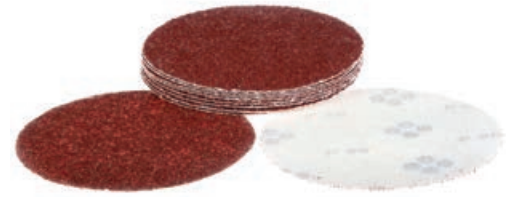

**ŚCIERNICA LISTKOWA DIAMENT**

Diamond flap disc • Диск лепестковый выпуклый • Diamant Fächerscheibe • Disc lamelar frontal diamant

NUMER KATALOGOWY			
060 097	125 mm	60	1/10/80
060 098	125 mm	120	1/10/80
060 099	125 mm	200	1/10/80
060 100	125 mm	400	1/10/80

**motive**  
Jakość ma znaczenie

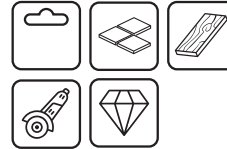

**ŚCIERNICA LISTKOWA WYPUKŁA**

Flap disc • Диск лепестковый выпуклый • Fächerscheibe • Disc lamelar frontal

NUMER KATALOGOWY			
060 090	125 mm	24	1/10/100
060 091	125 mm	36	1/10/100
060 092	125 mm	40	1/10/100
060 093	125 mm	60	1/10/100
060 094	125 mm	80	1/10/100
060 095	125 mm	100	1/10/100
060 096	125 mm	120	1/10/100

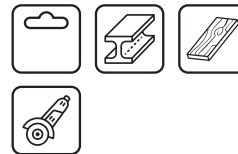

**KRAŻKI YELLOW PAD**

Velcro Yellow Pad • Шлифовальный диск "YELLOW PAD" • Klett-Schleifpapier perforiert • Hartie abraziva pentru masina de slefuit

NUMER KATALOGOWY			
060 210	225 mm	40	1/10/100
060 211	225 mm	60	1/10/100
060 212	225 mm	80	1/10/100
060 213	225 mm	100	1/10/100
060 214	225 mm	120	1/10/100
060 215	225 mm	150	1/10/100
060 216	225 mm	180	1/10/100
060 217	225 mm	220	1/10/100

**motive**  
Jakość ma znaczenie



**KRAŻEK SUPERPAD**

Velcro superpad • Шлифовальный диск "SUPERPAD" • Klett-Schleifpapier perforiert • Hartie abraziva pentru masina de slefuit

NUMER KATALOGOWY			
060 069	225 mm	40	1/25
060 062	225 mm	60	1/25
060 063	225 mm	80	1/25
060 064	225 mm	100	1/25
060 065	225 mm	120	1/25
060 066	225 mm	150	1/25
060 067	225 mm	180	1/25
060 068	225 mm	220	1/25

**WOOSTER®****MOP DO CZYSZCZENIA GŁADZI**

Dust eater • Швабра для очистки гипса от пыли • Mopp Staubfresser

NUMER KATALOGOWY		
1800	16" (41 cm)	1/2

**WOOSTER®****ZAPAS DO MOPA DO CZYSZCZENIA GŁADZI**

Dust eater refill • Запаска для швабры для гипса • Ersatz für Staubfresser Mopp

NUMER KATALOGOWY		
1805	16" (41 cm)	1/3

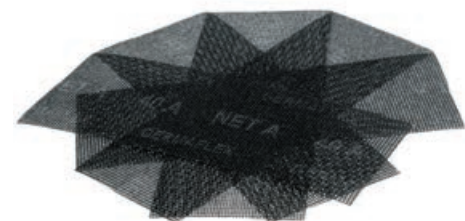

**SIATKA ŚCIERNA 5 SZT.**

Sanding mesh (5 pcs) • Абразивная сетка (5 шт.) • Schleifgitter (5 Stück) • Sita abraziva pentru suprafete gletuite

NUMER KATALOGOWY			
060 000	115 mm x 280 mm	40	1/10
060 001	115 mm x 280 mm	60	1/10
060 002	115 mm x 280 mm	80	1/10
060 003	115 mm x 280 mm	100	1/10
060 004	115 mm x 280 mm	120	1/10
060 005	115 mm x 280 mm	150	1/10
060 006	115 mm x 280 mm	180	1/10
060 007	115 mm x 280 mm	220	1/10



**GĄBKA DO SZLIFOWANIA**

Sanding sponge • Губка для шлифования • Schleifschwamm • Burete abraziv

NUMER KATALOGOWY		
060 178	40	1/10/50
060 181	46	1/250
060 182	60	1/250
060 183	80	1/250
060 184	100	1/250
060 185	120	1/250
060 186	150	1/250
060 187	180	1/250
060 188	220	1/250



**motive**  
*Jakość ma znaczenie*
**GĄBKA DO SZLIFOWANIA SKOŚNA**

Angled sanding sponge • Губка для шлифования остроугольная • Schleifschwamm schräg • Burete abraziv multifuncțional

NUMER KATALOGOWY		
060 190	60	1/100
060 191	80	1/100
060 192	100	1/100
060 193	120	1/100
060 194	150	1/100
060 195	180	1/100
060 196	220	1/100

**motive**  
*Jakość ma znaczenie*
**GĄBKA DO SZLIFOWANIA DIAMANT**

Diamond sanding sponge • Губка для шлифования • Diamant-Schleifschwamm • Burete abraziv diamant

NUMER KATALOGOWY		
060 220	60	1/10/100
060 221	120	1/10/100
060 222	200	1/10/100
060 223	400	1/10/100

**motive**  
*Jakość ma znaczenie*
**STRUG (FAZOWNIK) DO PŁYT GIPS-KARTON**

Plasteboard planner • Рубанок кромочный для гипсокартона • Hobel für Gipskartonplatten • Rindea pentru gips carton

NUMER KATALOGOWY	
060 176	1/48

**motive**  
*Jakość ma znaczenie*





**motive**  
Jakość ma znaczenie

**OSTRZA DO (FAZOWNIKA) STRUGA PŁYT G-K**

Plasterboard planner blades • Лезвия для рубанка кромочного  
• Ersatzmesser für Kantenhobel • Rezerve lame rindea pt gips-carton

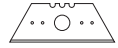
NUMER  
KATALOGOWY



060 177

x3

x3

1/200



**motive**  
Jakość ma znaczenie

**TARNIK TYP BLOK**

Surform block plane • Шлифованный брусок • Blockhobel  
• Razuitoare gips-carton

NUMER  
KATALOGOWY



060 169

140 mm

1/10/50

060 170

250 mm

1/5/50

**OSTRZE DO TARNIKA**

Surform refill blade • Лезвие для шлифовального бруска  
• Ersatzblatt für Blockhobel • Rezerva rindea pentru gips carton

NUMER  
KATALOGOWY



060 171

250 mm

1/60

060 172

140 mm

1/120

**CYKLINA**

Floor scraper • Цикля • Ziehklinge amerikanische Form • Räuzeug

NUMER  
KATALOGOWY



060 140

40 mm x 190 mm

1/75

060 141

60 mm x 200 mm

1/50

**SZCZOTKA DOCZOŁOWA DF Z NAKRĘTKĄ M14**

Waved wire cup brush with M14 thread • Щетка крацовка нас. с гайкой M14, из витой проволоки • Topfbürste, Stahl, gewellter Draht M14 • Perie sarma cupa

NUMER  
KATALOGOWY

max  
R.P.M.

090 500

60 mm

12500

1/10/100

090 501

80 mm

12500

1/10/100

090 502

100 mm

8500

1/4/40

090 503

125 mm

6500

1/4/24

**motive**  
Jakość ma znaczenie



**SZCZOTKA DOCZOŁOWA DF-TRZPIEŃ 6 mm**

Waved wire cup brush with 6 mm shank • Щетка крацовка со стержнем, из витой проволоки 6 мм • Topfbürste gewellt für Bohrmaschinen, 6 mm Schaft • Perie sarma cupa

NUMER KATALOGOWY		max R.P.M.	
090 504	50 mm	4500	1/10/200
090 505	63 mm	4500	1/10/120
090 506	75 mm	4500	1/10/120

**motive**  
Jakość ma znaczenie

**SZCZOTKA DOCZOŁOWA DS Z NAKRĘTKĄ M14**

Twisted wire cup brush with M14 thread • Щетка крацовка с гайкой M14/со скрученной проволоки • Topfbürste, Stahl, gezopfter Draht M14 • Perie sarma cupa M14

NUMER KATALOGOWY		max R.P.M.	
090 507	65 mm	12500	1/10/100
090 508	80 mm	12500	1/10/100
090 509	100 mm	8500	1/4/40
090 510	125 mm	6500	1/24

**motive**  
Jakość ma znaczenie

**SZCZOTKA DOCZOŁOWA DS - TRZPIEŃ 6 mm**

Twisted wire cup brush with 6 mm shank • Щетка крацовка со стержнем, со скрученной проволоки 6 мм • Topfbürste gezopft für Bohrmaschinen, 6 mm Schaft • Perie sarma cupa

NUMER KATALOGOWY		max R.P.M.	
090 511	65 mm	12500	1/10/120

**motive**  
Jakość ma znaczenie

**SZCZOTKA DOCZOŁOWA DF STOŻKOWA M14**

Waved wire bevel brush with M14 thread • Щетка конусная с гайкой M14, из витой проволоки • Kegelbürste, gewellter Draht M14 • Perie sarma rotunda M14

NUMER KATALOGOWY		max R.P.M.	
090 513	100 mm	12500	1/10/100
090 514	115 mm	12500	1/10/60
090 515	125 mm	12500	1/10/60

**motive**  
Jakość ma znaczenie



**SZCZOTKA DOCZOŁOWA DS STOŻKOWA M14**

Twisted wire bevel brush with M14 thread • Щетка конусная с гайкой M14, из витой проволоки • Kegelbürste, gezopfter Draht M14 • Perie sarma rotunda M14

NUMER KATALOGOWY		max R.P.M.	
090 516	100 mm	12500	1/10/100
090 517	115 mm	12500	1/60

**SZCZOTKA TARCZOWA DRUT SKRĘCANY**

Twisted wire circular brush • Щетка дисковая, со скрученной проволоки • Scheibenbürste für Winkelschleifer • Perie sarma rotunda

NUMER KATALOGOWY		max R.P.M.	
090 520	100 mm	11 000	1/12/120
090 521	115 mm	11 000	1/6/60
090 522	125 mm	11 000	1/6/60

**SZCZOTKA TARCZOWA DRUT FALOWANY**

Waved wire circular brush • Щетка дисковая, из витой проволоки • Scheibenbürste für Winkelschleifer • Perie sarma rotunda

NUMER KATALOGOWY		max R.P.M.	
090 523	100 mm	4 500	1/12/120
090 524	115 mm	4 500	1/10/60
090 525	125 mm	4 500	1/6/60

**SZCZOTKA TARCZOWA DRUT FALOWANY, TRZPIEŃ**

Waved wire circular brush with shaft • Щетка дисковая со стержнем, из витой проволоки • Scheibenbürste • Perie sarma rotunda

NUMER KATALOGOWY		max R.P.M.	
090 526	80 mm	4 500	1/20/120
090 527	100 mm	4 500	1/14/84

**SZCZOTKA DRUCIANA SOFT**

Wire brush with soft grip handle • Проволочная щетка "SOFT" • Drahtbürste mit Schaber Soft • Perie sarma Soft

NUMER KATALOGOWY			
090 116	300 mm	4-rzędowa/4 rows	1/10/60



**SZCZOTKA DRUCIANA UCHWYT PLASTIKOWY**

Wire brush, plastic handle • Проволочная щетка пласт. • Stahldrahtbürste "vermessingt" • Perie sarma maner plastic

NUMER KATALOGOWY	↔	
090 115	240 mm	1/12/120

**SZCZOTKA DRUCIANA**

Wire brush, wooden handle • Проволочная щетка • Drahtbürste • Perie sarma

NUMER KATALOGOWY		
090 110	4-rzędowa/4 rows	1/12/120
090 111	5-rzędowa/5 rows	1/12/120
090 112	6-rzędowa/6 rows	1/12/120

**SZCZOTKA DRUCIANA PROFI**

Wire brush PROFI, wooden handle • Проволочная щетка ПРОФИ • Drahtbürste Profi • Perie sarma Profi

NUMER KATALOGOWY		
090 113	4-rzędowa/4 rows	1/50
090 114	5-rzędowa/5 rows	1/50







# ARTYKUŁY GLAZURNICZE I NARZĘDZIA DO TAPETOWANIA

ИНСТРУМЕНТ ДЛЯ ОБЛИЦОВОЧНЫХ РАБОТ И НАКЛЕИВАНИЯ ОБОЕВ • TILING ACCESSORIES AND WALLPAPERING TOOLS  
• FLIESEN- UND TAPETIERZUBEHÖR • SCULE MONTAJ PLACI CERAMICE



# KLIPSY

DO WYBORU, DO KOLORU **NOWOŚĆ**

Dla wygody Twojej pracy wprowadziliśmy nową serię kolorowych klipsów glazurniczych. Ich stosowanie wraz z dostępnymi w sprzedaży klinami to wydajniejszy sposób układania płytek. **Pozwalają na pracę bez konieczności użycia krzyżyków dystansowych, a nawet poziomic.** Demontaż klipsów po całkowitym wyschnięciu płytek jest bardzo łatwy. Polega on bowiem na zerwaniu klipsa poprzez kopnięcie lub lekkie uderzenie szpachelką albo gumowym młotkiem. Zaschnięta w kleju stopka klipsa pozostanie pod płytką nie kolidując z fugowaniem i absolutnie bez wpływu na dalszą eksploatację posadzki, czy ściany z płytkami. Klipsy pakowane są po 30 lub 100 szt., co pozwala dobrać odpowiednią ilość klipsów do swojej pracy. Zastosowana grubość klipsów decyduje o szerokości spoiny między płytkami.

DO MNIEJSZYCH PŁYTEK  
I ZASTOSOWANIA CIENKIEJ FUGI

DO WIĘKSZYCH FORMATÓW PŁYTEK  
I GRUBSZYCH

<b>STANDARD</b> <b>1</b> mm nr kat. 070 081 - 30 szt. nr kat. 070 078 - 100 szt.	<b>STANDARD</b> <b>1,5</b> mm nr kat. 070 073 - 30 szt. nr kat. 070 074 - 100 szt.	<b>STANDARD</b> <b>2</b> mm nr kat. 070 083 - 30 szt. nr kat. 070 079 - 100 szt.	<b>STANDARD</b> <b>3</b> mm nr kat. 070 087 - 100 szt.	<b>WYSOKIE</b> <b>2</b> mm nr kat. 070 085 - 100 szt.
--	--	--	---	--





### PODNOŚNIK/WSPORNIK GLAZURNICZY

Tile lifter • Устройство для поднятия и выравнивания плитки • Fliesen-und Plattenheber • Unealta manuala pentru pozitionare nivelare placi ceramic

NUMER KATALOGOWY			
070 060	105 kg	1 - 40,5 cm	1



### PRZYSSAWKA Z MANOMETREM

Vacuum suction cup • Вакуумная присоска для плитки и стекла с манометром • Vakuum Saugheber mit Manometer • Ventuza extra-puternica

NUMER KATALOGOWY		
070 065	100 kg	1



### SYSTEM POZIOMOWANIA PŁYTEK WIELOKROTNEGO UŻYTKU

Reusable tile leveling system • Система за изравняване на плочки за многократна употреба • Wiederverwendbar Fliesen Nivelliersystem • Sistem reglabil, reutilizabil de nivelare a plăcilor

NUMER KATALOGOWY				
070 089	50 szt.	1,5 mm	16 mm	1/25



### PODKŁADKI POD SYSTEM POZIOMOWANIA

Universal Transparent Plastic washer with hollow • Универсальная прозрачная подкладка с полостью • Unterlegscheiben für Zughauben 100 Stk. • Protectie placa ceramica pentru distantieri nivelare cu infiletare

NUMER KATALOGOWY		
070 050	100 szt.	1/12/48



### KLIPSY DO POZIOMOWANIA PŁYTEK

Tile leveling clips • Клипсы для выравнивания плиток • Zuglaschen • Distantiere pentru gresie si faianta

NUMER KATALOGOWY			
Do płytek o grubości do 12 mm			
070 081	30 szt.	1 mm	1/10/40
070 073	30 szt.	1,5 mm	1/10/40
070 083	30 szt.	2 mm	1/10/40
070 078	100 szt.	1 mm	1/10/40
070 074	100 szt.	1,5 mm	1/10/40
070 079	100 szt.	2 mm	1/10/40
070 087	100 szt.	3 mm	1/10/40
Do płytek o grubości od 12 mm do 20 mm			
070 085	100 szt.	2 mm	1/10





**motive**  
Jakość ma znaczenie

#### WIADRO 33L Z KLIPSAMI (1000 SZT.)

Plastic bucket with lid + Tile leveling clips • Ведро с крышкой + Клипсы для выравнивания плиток • Eimer mit Deckel + Zuglaschen • Găleată cu sarac + Distantiere pentru gresie si faianta

NUMER KATALOGOWY				
070 068	33 L	1000 szt.	1 mm	1
070 069	33 L	1000 szt.	2 mm	1
070 072	33 L	1000 szt.	3 mm	1



**motive**  
Jakość ma znaczenie

#### WIADRO 10L Z KLIPSAMI (300 SZT.)

Plastic bucket with lid + Tile leveling clips • Ведро с крышкой + Клипсы для выравнивания плиток • Eimer mit Deckel + Zuglaschen • Găleată cu sarac + Distantiere pentru gresie si faianta

NUMER KATALOGOWY				
070 054	10 L	300 szt.	1 mm	1
070 055	10 L	300 szt.	1,5 mm	1
070 056	10 L	300 szt.	2 mm	1
070 057	10 L	300 szt.	2 mm wysokie	1
070 058	10 L	300 szt.	3 mm	1



**motive**  
Jakość ma znaczenie

#### KLINY DO POZIOMOWANIA PŁYTEK

Tile leveling wedges • Клинья для выравнивания плиток • Fliesen Nivelliersystem- Keile • Pene nivelare placi ceramice



NUMER KATALOGOWY		
070 076	50 szt.	1/10/40
070 077	100 szt.	1/10/40



**motive**  
Jakość ma znaczenie

#### WIADRO 10L Z KLINAMI (200 SZT.)

Plastic bucket with lid + Tile leveling wedges • Ведро с крышкой + Клинья для выравнивания плиток • Eimer mit Deckel + Fliesen Nivelliersystem- Keile • Găleată cu sarac + Pene nivelare placi ceramice

NUMER KATALOGOWY			
070 075	10 L	200 szt.	1



**motive**  
Jakość ma znaczenie

#### KLINY + KLIPSY DO POZIOMOWANIA PŁYTEK - 30 KPL

Tile leveling wedges & clips, 30 pcs • Клинья и клипсы для выравнивания плиток (30 компл.) • Nivelliersystem- Laschen und Keile (30 Stücke) • Sistem de nivelare gresie si faianta (30 buc)



NUMER KATALOGOWY				
070 080	30 szt.	30 szt.	1 mm	1/10/20
070 082	30 szt.	30 szt.	2 mm	1/10/20



### PODKŁADKI POD KLIPSY DO POZIOMOWANIA

Anti-Scratch washer • Пластиковая платформа • Unterlegscheiben für Keile  
• Protecție placă ceramică pentru distanțieri nivelare

NUMER  
KATALOGOWY



070 052

100 szt.

1/10/20

**motive**  
Jakość ma znaczenie



### PODKŁADKI NAROŻNE POD KLIPSY DO POZIOMOWANIA

Plastic corner bracket • Пластиковый угловой кронштейн • Nivellierecken  
• Distanțieri nivelare pentru colțuri

NUMER  
KATALOGOWY



070 051

25 szt.

1/10/20

**motive**  
Jakość ma znaczenie



### SZCZYPCE DO SYSTEMU POZIOMOWANIA PŁYTEK

Tile leveling plier • Щипцы для системы выравнивания плиток • Zange für Bodenverlegung • Clește pentru distanțiere autonivelante

NUMER  
KATALOGOWY



070 086

1/6/24

**motive**  
Jakość ma znaczenie



### ZESTAW DO POZIOMOWANIA PŁYTEK

Tile leveling system • Комплект для системы выравнивания плиток  
• Fliesen Nivelliersystem • Sistem de nivelare gresie și faianță clips, pene

NUMER  
KATALOGOWY



070 088

1 szt.

100 szt.

1 mm

100 szt.

1

**motive**  
Jakość ma znaczenie



### KLIPSY DO POZIOMOWANIA PŁYTEK 30 KPL

Tile leveling clips, 30 pcs • Клипсы для выравнивания плиток (30 шт.)  
• Zuglaschen (30 Stücke) • Distanțieri pentru gresie și faianță (30 buc)

NUMER  
KATALOGOWY



070 118

30 szt.

1,3 mm

1/50





#### KLINY I KLIPSY DO POZIOMOWANIA PŁYTEK 30 KPL

Tile leveling wedges & clips, 30 sets • Клинья и клипсы для выравнивания плиток (30 компл.) • Nivelliersystem- 30 Stücke Laschen und Keile • Sistem de nivelare gresie si faianta

NUMER  
KATALOGOWY



070 117

30 szt.

30 szt.

1,3 mm

1/50



#### KLINY MONTAŻOWE

Plastic wedges, 30 sets • Монтажные клинья • Montagekeile • Set pene distantiere montaj parchet, parchet laminat, PVC

NUMER  
KATALOGOWY



070 071

10 szt.

90 x 43 x 13 mm

1/50

070 070

50 szt.

90 x 43 x 13 mm

1/50



#### KOMPLET GLAZURNICZY

Tiling set • Набор для облицовочных работ • Fliesenlegersset • Set pentru curatat gresie & faianta

NUMER  
KATALOGOWY



070 170

24 l

1



#### WIADRO GLAZURNICZE Z ROLKAMI

Grout cleaning bucket • Ведро для облицовочных работ с роликами • Fliesenwaschset • Galeata pentru curatat gresie & faianta

NUMER  
KATALOGOWY



070 171

24 l

1/20



#### KÓŁKA DO WIADRA GLAZURNICZEGO 4szt.

Wheels for grout cleaning bucket • Колесики к ведру для облицовочных работ • Rädchen für Fliesen-Wascheimer • Roti pentru galeata gresie

NUMER  
KATALOGOWY



070 175

1



#### ROLKI DO WIADRA GLAZURNICZEGO

Spare rollers for grout cleaning bucket • Ролики для ведра для облицовочных работ • Rollenaufsatz für wascheimer • Role de stoarcere

NUMER  
KATALOGOWY





070 172

1/40





### KRZYŻYKI DYSTANSOWE Z UCHWYTEM

Tile spacers with a holder • Крестики для плитки с держателем  
• Fliesenkreuze mit Griff • Distantiere pentru gresie si faianta

NUMER KATALOGOWY			
070 090	100 szt.	1,5 mm	1/50
070 091	100 szt.	2 mm	1/50
070 092	100 szt.	2,5 mm	1/50
070 093	100 szt.	3 mm	1/50
070 094	100 szt.	4 mm	1/50



### KRZYŻYKI DYSTANSOWE

Tile spacers • Крестики для плитки • Fliesenkreuze  
• Distantiere pentru gresie si faianta

NUMER KATALOGOWY			
070 100	150 szt.	1 mm	1/50
070 101	150 szt.	1,5 mm	1/50
070 102	150 szt.	2 mm	1/50
070 103	150 szt.	2,5 mm	1/50
070 104	150 szt.	3 mm	1/50
070 105	100 szt.	3,5 mm	1/50
070 106	100 szt.	4 mm	1/50
070 107	75 szt.	5 mm	1/50
070 108	50 szt.	6 mm	1/50
070 109	30 szt.	8 mm	1/50
070 110	30 szt.	10 mm	1/50



### T DO PŁYTEK KLINKIEROWYCH

Clinker brick crosses • Крестики "Т" для плитки • Fliesen T-Stücke  
• Distantiere pentru gresie si faianta T

NUMER KATALOGOWY			
070 111	50 szt.	6 mm	1/50
070 112	30 szt.	8 mm	1/50
070 113	30 szt.	10 mm	1/50



### KLINY TYP C

Tile spacers C-type • Клинья для выравнивания плитки тип „C”  
• Fliesenkeile C-Form • Pene distantiere pentru gresie tip C

NUMER KATALOGOWY			
070 114	50 szt.	1-12 mm	1/10/100

### KLINY

Tile wedges • Клинья для плитки • Fliesenkeile • Pana pentru faianta

NUMER KATALOGOWY			
070 115	100 szt.	małe / small	1/50
070 116	30 szt.	duże / large	1/50

**motive**  
Jakość ma znaczenie



**motive**  
Jakość ma znaczenie



**motive**  
Jakość ma znaczenie



**motive**  
Jakość ma znaczenie



**motive**  
Jakość ma znaczenie





**motive**  
Jakość ma znaczenie



#### DOZOWNIK DO FUG

Grout Bag • Рукав для затирки швов • Mörtelbeutel • Dispozitiv pentru chituire

NUMER  
KATALOGOWY



070 310	plastikowa końcówka/plastic tip	1/10/50
070 311	metalowa końcówka/ metal tip	1/10/50



#### FUGOWNICA

Grout spreader • Шпатель резиновый для швов • Fugengummi mit Holzgriff • Spaclu cauciuc

NUMER  
KATALOGOWY



070 130	150 mm	1/10/50
070 131	200 mm	1/10/50
070 132	250 mm	1/10/50



**motive**  
Jakość ma znaczenie



#### GĄBKA HYDRO

Grout sponge Hydro • Губка для облицовочной плитки HYDRO • Hydroschwamm • Burete Hidro

NUMER  
KATALOGOWY



070 126	70 mm	135 x 105 mm	1/50
---------	-------	--------------	------



#### GĄBKA SYNTETYK DO GLAZURY

Grout sponge • Губка для облицовочной плитки SYNTETYK • Fliesenschwamm Synthetisch • Burete absorbant

NUMER  
KATALOGOWY



070 169	70 mm	230 x 120 mm	1/5
---------	-------	--------------	-----



#### GĄBKA DO GLAZURY

Grout sponge • Губка для облицовочной плитки • Fliesenschwamm • Burete universal

NUMER  
KATALOGOWY



070 135	70 mm	140 x 110 mm	1/10
---------	-------	--------------	------



**motive**  
Jakość ma znaczenie



#### GĄBKA DO FUG EPOKSYDOWYCH

Epoxy grout tile sponge • Глазурованная губка • Epoxid Fliesenschwamm • Burete celuloza Epoxi

NUMER  
KATALOGOWY



070 127	54 mm	185 x 110 mm	1/100
---------	-------	--------------	-------





### GĄBKA Z GUMA

Grout sponge with rubber • Губка с резиной • Fliesenschwamm mit dem Gummi • Burete universal



NUMER  
KATALOGOWY



070 136

70 mm

140 x 110 mm

1/30

### PACA DO SPOINOWANIA

Epoch grout float • Терка для фуговки • Fugenbrett • Drisca cauciuc dur



NUMER  
KATALOGOWY



070 137

16 mm

240 x 100 mm

1/12/36

### PACA DO FUGOWANIA Z GUMA ŚCIĘTA

Grout float • Резиновая терка для фуговки • Fugenbrett für Fliesen • Gletiera cauciuc



NUMER  
KATALOGOWY



070 138

250 x 90 mm

1/30

### ZAPAS GUMOWY DO PACY FUGOWEJ

Grout float refill • Запаска резиновая для терки для фуговки • Ersatzbelag für Fugenbrett • Reserva pentru gletiera cauciuc



NUMER  
KATALOGOWY



070 129

16 mm

250 x 100 mm

1/10

### PACA Z WŁÓKNINĄ

Scrub float with pads • Терка с тканью • Pad-Handbrett für Exoxidverfugungen • Gletiera curatat gresie



NUMER  
KATALOGOWY



070 166

250 x 95 mm

1/10



#### WŁÓKNINA BIAŁA

Replacement pad- white for polishing • Ткань белая (мягкая для полеровки)  
• Vliesauflage weiss (fein) • Rezerva abraziva, alba

NUMER  
KATALOGOWY



070 167

biała / white

1/10



#### WŁÓKNINA CZARNA

Replacement pad- black for cleaning • Ткань черная (грубая для чистки)  
• Vliesauflage schwarz (grob) • Rezerva abraziva, negru

NUMER  
KATALOGOWY



070 168

czarna / black

1/10



#### WOLFRAMOWY SKROBAK DO FUG

Tungsten grout rake • Вольфрамовая брусочка для швов  
• Fugenreiniger Hartmetall • Razuitoare placi ceramice

NUMER  
KATALOGOWY



070 164

1/10/100



#### SKROBAK DO FUG

Sealant remover • Брусочка для швов • Fugenkratzer  
• Razuitoare placi ceramice

NUMER  
KATALOGOWY



070 165

1/10/100

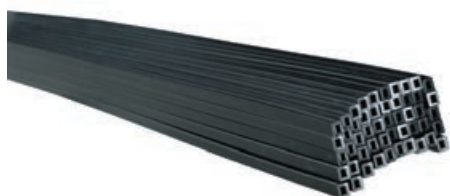

#### LISTWA DO KLINKIERU

Brick wall spacer • Планка выравнивающая для плитки • Leiste für Klinker  
• Profil de distantiere pentru clincher

NUMER  
KATALOGOWY



070 144

0,8 x 1,0 x 200 cm

50

040 154

1,0 x 1,0 x 200 cm

50



### MASZYŃKA DO GLAZURY

Tile cutter • Плиткорез ручной • Fliesenschneider • Masina de taiat faianta

NUMER KATALOGOWY	↔	
070 139	400 mm	1/10

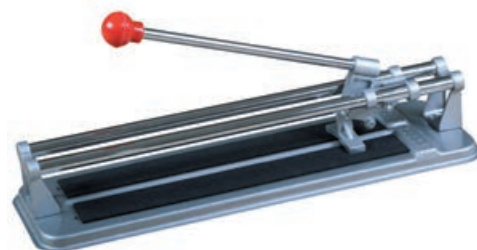

### MASZYŃKA DO GLAZURY 3 FUNKCYJNA

Tile cutter with tile hole cutter • Плиткорез ручной 3 функции • Fliesenschneider • Masina de taiat faianta, cu 3 functii

NUMER KATALOGOWY	↔	
070 141	480 mm	1/4

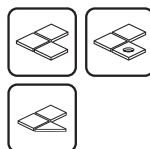

### MASZYŃKA DO GLAZURY PROFI



Tile cutting machine PROFI • Плиткорез ручной "PROFI" • Fliesenschneider Profi • Masina de taiat faianta

NUMER KATALOGOWY	↔	
070 142	600 mm	1/4



### KÓŁKO WYMIENNE ZE ŚRUBĄ

Tile cutter wheel • Запасной ролик с винтом для плиткореза • Ersatz Schneidrad • Rola schimb

NUMER KATALOGOWY		
070 150	15 mm	1/100
070 151	16 mm	1/100
070 152	22 mm	1/100



### RYSIK DO GLAZURY

Etching pen • Карандаш для плитки • Reißnadel • Ac de trasat

NUMER KATALOGOWY	↔	
070 148	140 mm	1/50/500





#### OTWORNICA DO GLAZURY

Hole cutter • Сверло для облицовочной плитки • Fliesenlochbohrer  
• Burghiu pentru gresie

NUMER  
KATALOGOWY



070 145

30 - 110 mm

1/12



#### PRZYRZĄD DO UKŁADANIA GLAZURY

Tile leveling set • Инструмент для облицовочных работ • Fliesenlegerecken  
• Dispozitiv aliniere gresie & faianta

NUMER  
KATALOGOWY



070 120

45 x 40 mm

1/60



#### UCHWYTY MAGNETYCZNE DO GLAZURY

Tiled magnetic catches • Магнитный замок для облицовочных плиток  
• Fliesenmagnet Satz • Set magneti pentru usa de vizitare din faianta

NUMER  
KATALOGOWY



070 125

1/100



#### WYKROJNIK

Profile contour gauge • Шаблон для плитки • Konturenlehre  
• Sablon masurare profil

NUMER  
KATALOGOWY



070 121

250 mm

1/10/40



#### SZABLON DO KSZTAŁTÓW

Multi angle template tool • Универсальная шестистворчатая линейка, регулируемая • Winkelschablone • Rigla sablon multi-ungghi

NUMER  
KATALOGOWY



070 123



26, 41, 46 mm

1/10/40



### ROLKA DO TAPET

Wallpaper press on roller • Валик для обоев • Nahtroller • Trafalet pentru tapet

NUMER KATALOGOWY		
070 220	5 cm	1/50
070 221	15 cm	1/40



### SZPACHELKA DO TAPET

Wallpaper smoother • Шпатель обойный • Tapezierspachtel • Spatula pentru montajul tapetului

NUMER KATALOGOWY		
070 301	17 x 27 cm	1/50



### NÓŻ POCKET

Folding utility knife POCKET • Нож POCKET • Klappmesser mit Trapezklinge POCKET • Cutter universal



NUMER KATALOGOWY		
070 196	x3	1/12/48

**motive**  
Jakość ma znaczenie



### NÓŻ SECURO

Knife cutter SECURO • Нож SECURO • Messer SECURO • Cutter universal



NUMER KATALOGOWY			
070 197	x1	18 mm	1/12/24

**motive**  
Jakość ma znaczenie



### NÓŻ BLACK

Knife cutter BLACK • Нож BLACK • Messer BLACK • Cutter universal

NUMER KATALOGOWY			
070 178	x3	9 mm	1/10
070 179	x1	18 mm	1/10

**motive**  
Jakość ma znaczenie





**motive**  
Jakość ma znaczenie



### NÓŻ 2BLADES

Knife cutter 2BLADES • Нож 2BLADES • Messer mit zwei Klingen  
• Cutter multifunctional cu 2 lame

NUMER  
KATALOGOWY

070 181



x2



x2



1/12/48



**motive**  
Jakość ma znaczenie



### NÓŻ AUTOMATYCZNY

Self-loading cutter • Нож с автоматической сменой лезвий  
• Abbrechmesser mit automatischer Nachladung • Cutter universal

NUMER  
KATALOGOWY

070 187



x5



18 mm



1/6/72



**motive**  
Jakość ma znaczenie



### NÓŻ PUSH-LOCK

Cutter Push-Lock • Нож Push-Lock • Messer PUSH-LOCK • Cutter universal

NUMER  
KATALOGOWY

070 182



x1



18 mm



1/12/144



**motive**  
Jakość ma znaczenie



### NÓŻ DO KARTONU

Box cutter • Нож для картонных коробок • Saugus peilis • Kartonmesser

NUMER  
KATALOGOWY

070 183



x4



1/12/72



**motive**  
Jakość ma znaczenie



### NÓŻ HAKOWY

Hook blade cutter • Нож с лезвием крюком • Hakenmesser  
• Cutter multifunctional cu lame carlig

NUMER  
KATALOGOWY

070 189



x3



1/6/72





### NÓŻ Z OSTRZEM ŁAMANYM

Cutter, soft handle • Строительный нож • Abbrechmesser für Abbrechklingen  
• Cutter universal

NUMER KATALOGOWY			
070 207	x1	25 mm	1/12/120
070 208	x1	18 mm	1/12/48

**motive**  
Jakość ma znaczenie



### NÓŻ ŁAMANY PROFIL

Cutter, soft handle PROFIL • Строительный нож "PROFIL"  
• Profi-Abbrechklingen-Messer • Cutter universal + 5 lame

NUMER KATALOGOWY			
070 190	x 5	18 mm	1/12/72

**motive**  
Jakość ma znaczenie



### NÓŻ DO WYKŁADZIN

Carpet cutter • Нож для ковровых покрытий • Teppichschneider  
• Cutter pentru mocheta

NUMER KATALOGOWY		
070 195	x1	8/80



### NÓŻ INTERLOCK

Snap off cutter "INTERLOCK" • Нож "INTERLOCK" • Interlock Messer  
• Cutter Interlock

NUMER KATALOGOWY			
070 201	x1	18 mm	1/12/144



### NÓŻ ŁAMANY

Snap off cutter • Строительный нож • Universalmesser Kunststoff  
• Cutter universal

NUMER KATALOGOWY			
070 202	x1	18 mm	1/25/250





#### NÓŻ ŁAMANY ABS

Snap off cutter ABS • Строительный нож "ABS" • Abbrechmesser ABS • Cutter universal ABS

NUMER  
KATALOGOWY



070 204

x1

18 mm

1/25/250



#### NÓŻ ŁAMANY KÓŁKO

Snap off cutter with wheel • Строительный нож • Abbrechmesser mit Metallführung und Drehknopf • Cutter cu protectie

NUMER  
KATALOGOWY



070 205

x1

18 mm

1/25/250



#### NÓŻ ŁAMANY WZMOCNIONY

Snap off cutter reinforced • Строительный нож усиленный • Abbrechmesser mit Stahlführung • Cutter cu protectie

NUMER  
KATALOGOWY



070 203

x1

18 mm

1/25/250

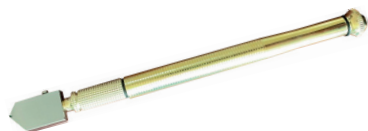

#### NÓŻ DO SZKŁA OLEJOWY

Oil glass cutter • Стеклорез масляный • Öl-Glasschneider • Cutit pentru taierea sticlei cu rezervor de ulei

NUMER  
KATALOGOWY



070 185

1/6/120



#### NÓŻ DO SZKŁA

Glass cutter • Нож для стекла • Glasschneider • Diamant sticla

NUMER  
KATALOGOWY



070 209

1/12/120





### NOŻYK DO FOLII

Foil & tape cutter • Нож для плёнки • Folienmesser • Cutter pentru folie

NUMER  
KATALOGOWY



070 180

1/24/144

**motive**  
Jakość ma znaczenie



### NÓŻ METALOWY TRAPEZOWY

Cutter with trapeze blades • Металлический нож (трапеция)  
• Trapezmesser • Cutter cu lama trapezoidală

NUMER  
KATALOGOWY



070 206

x1

1/10/100



### NÓŻ DO WEŁNY

Knife cutter for insulation • Нож для теплоизоляции • Dämmstoffmesser,  
doppelschneidig • Cutit pentru taiat vata minerală

NUMER  
KATALOGOWY



070 192

280 mm

1//10/100

**motive**  
Jakość ma znaczenie



### NÓŻ DO WEŁNY Z KABURĄ

Knife cutter for insulation with sheath • Нож для теплоизоляции с кобурой  
• Dämmstoffmesser, doppelschneidig • Cutit pentru taiat vata minerală

NUMER  
KATALOGOWY



070 193

280 mm

1/12/72

**motive**  
Jakość ma znaczenie



### NOŻYCZKI MONTERSKE

Heavy duty scissors • Ножницы монтажные • Drahtschere • Foarfeca elctrician

NUMER  
KATALOGOWY



070 198

14 cm

1/12/1200

**motive**  
Jakość ma znaczenie





**motive**  
Jakość ma znaczenie



**NOŻYCZKI UNIWERSALNE**

Long blade scissors • Ножницы универсальные • Haushaltsschere • Foarfece

NUMER  
KATALOGOWY



070 199

28 cm

1/12/72



**motive**  
Jakość ma znaczenie



**OSTRZA BLACK (10 SZT.)**

Blades for cutter (10 pcs) • Лезвия отламывающиеся сменные (10 шт.)  
• Abbrecklingen (10 Stück im Spender) • Lame pentru cuttere (10 bucati)

NUMER  
KATALOGOWY



070 176

9 mm

12/144

070 177

18 mm

12/96



**motive**  
Jakość ma znaczenie



**OSTRZA ŁAMANE (10 SZT.)**

Blades for cutter (10 pcs) • Лезвия отламывающиеся сменные (10 шт.)  
• Abbrecklingen (10 Stück im Spender) • Lame pentru cuttere (10 bucati)

NUMER  
KATALOGOWY



070 215

18 mm

12/144

070 219

25 mm

12/96



**OSTRZA ŁAMANE (10 SZT.)**

Blades for cutter (10 pcs) • Лезвия отламывающиеся сменные (10 шт.)  
• Abbrecklingen (10 Stück) • Lame pentru cuttere (10 bucati)

NUMER  
KATALOGOWY



070 211

18 mm

10/400



**OSTRZA ŁAMANE (5 SZT.)**

Blades for cutter (5 pcs) • Лезвия отламывающиеся сменные (5 шт.)  
• Abbrecklingen (5 Stück) • Lame pentru cuttere (5 bucati)

NUMER  
KATALOGOWY



070 214

25 mm

1/10/100





#### OSTRZA TRAPEZOWE (5 SZT.)

Trapeze blades (5 pcs) • Лезвия отламывающиеся сменные трапециевидные (5 шт.) • Trapezklingen (5 Stück) • Lame cutter, trapezoidale (5 bucati)

NUMER  
KATALOGOWY



070 218

1/24

**motive**  
Jakość ma znaczenie



#### OSTRZA TRAPEZOWE (5 SZT.)

Trapeze blades (5 pcs) • Лезвия отламывающиеся сменные трапециевидные (5 шт.) • Trapezklingen (5 Stück) • Lame cutter, trapezoidale (5 bucati)

NUMER  
KATALOGOWY



070 212

1/25/600



#### OSTRZA HAKOWE (5 SZT.)

Hook blades (5 pcs) • Лезвия крюки (5 шт.) • Hakenklingen (5 Stück) • Lame cutter, tip carlig

NUMER  
KATALOGOWY



070 213

1/25/600



#### OSTRZA DO NOŻA DO WYKŁADZIN (5 SZT.)

Blades for carpet cutter (5 pcs) • Лезвия для ножа для ковровых покрытий (5 шт.) • Ersatzklingen für Teppichschneider ( 5 Stück) • Lame pentru cutter mocheta (5 buc)

NUMER  
KATALOGOWY



070 217

25/200



#### SKROBAK DO SILIKONU

Silicone sealant scraper • Нож для удаления силикона • Silikon Fugenentferner • Unealta etansare silicon

NUMER  
KATALOGOWY



070 295

1/100

**motive**  
Jakość ma znaczenie





**motive**   
Jakość ma znaczenie



**SZPACHELKI DO SILIKONU (4 SZT.)**

Silicone sealant spreader (4 pcs.) • Шпателя для силикона (4 шт.)  
• Fugenglätter Set 4-teilig • Spatula pentru silicon (4 bucati)

NUMER  
KATALOGOWY



070 299

1/100



**SZPACHELKA DO SILIKONU**

Sealant smoother • Шпатель для силикона • Fugenglätter  
• Spatula pentru silicon

NUMER  
KATALOGOWY



070 300

1/20/400



**ZGARNIACZ WODY**

Squeegee • Скребок для удаления воды • Fliesenwischer  
• Racleta podea pentru apa

NUMER  
KATALOGOWY



070 133

450 mm

1/10/50

070 134

600 mm

1/10/30

070 128

750 mm

1/10/50



**motive**   
Jakość ma znaczenie

**ROLKA DO WYLEWEK**

Spiked aeration roller • Валик для удаления воздуха в стяжках  
• Entlüftungsrolle • Trafalet pentru sape

NUMER  
KATALOGOWY



070 161

110 mm

230 mm

1/10

070 162

75 mm

230 mm

1/10



**motive**   
Jakość ma znaczenie

**ROLKA DO WYLEWEK**

Spiked aeration roller • Валик для удаления воздуха в стяжках  
• Entlüftungsrolle • Trafalet pentru sape

NUMER  
KATALOGOWY



070 163

110 mm

500 mm

1/4/8

# TARCZE I WIERTŁA

ДИСКИ И СВЕРЛА • DISCS, DRILLS • TRENNSCHEIBEN UND BOHRER  
• DISCURI, BURGHE



# PROFESJONALNE TARCZE DIAMENTOWE

**motive**  
Jakość ma znaczenie



## TURBO BLADE

Skuteczne cięcie betonu i kamienia. Wytrzymałe obrzeże typu turbo umożliwia również cięcie stalowych prętów zbrojeniowych. Maksymalne obroty 13 200/min (w zależności od średnicy tarczy).

## MESHY BLADE

Ultracienka krawędź tnąca zapewniająca idealne cięcie glazury, terakoty, czy gresu. Grubość tarczy mniejsza niż 2 mm umożliwia również ukośne cięcia. Przeznaczona do pracy na sucho. Maksymalne obroty 13 200/min (w zależności od średnicy tarczy).



### TARCZE DIAMENTOWE TURBO BLADE/MESHY BLADE

Diamond cutting disc • Диск Meshy Blade/Turbo Blade  
• Diamanttrennscheibe Meshy Blade/Turbo Blade  
• Disc diamantat Meshy Blade/Turbo Blade

NUMER  
KATALOGOWY

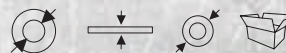

080 184	<b>MESHY BLADE</b>	22,2 mm	1,4 mm	115 mm	1/100
080 185		22,2 mm	1,4 mm	125 mm	1/100
080 186		22,2 mm	1,8 mm	230 mm	1/25
080 187	<b>TURBO BLADE</b>	22,2 mm	2,2 mm	115 mm	1/100
080 188		22,2 mm	2,4 mm	125 mm	1/100
080 189		22,2 mm	2,8 mm	230 mm	1/25

# ZESTAWY WIERTEŁ

**motive**  
Jakość ma znaczenie

## ZESTAW WIERTEŁ DO DREWNA



- zestaw od 4 mm do 10 mm
- stal węglowa

## ZESTAW WIERTEŁ HSS DO METALU



### GOLD BLACK

- zestaw od 1 mm do 10 mm
- wiertła ze stali szybkotnącej
- chwyt walcowy
- DIN 338

## ZESTAW WIERTEŁ SDS DO BETONU



- zestaw od 6 mm do 10 mm
- mocowanie SDS
- widie z wolframu



### ZESTAWY WIERTEŁ DO METALU • DREWNA • BETONU

NUMER  
KATALOGOWY



080 210



1-10 mm

1/50

080 211



4-10 mm

1/25/100

080 212



6-10 mm

1/40



**TARCA DIAMENTOWA MULTI-USE**

Diamond cutting disc • Диск алмазный Multi-Use • Diamanttrennscheibe Multi-Use • Disc diamantat Multi-Use

NUMER KATALOGOWY			
080 090	pełna/full	125 mm	1/50
080 091	segmentowa/segment	125 mm	1/50

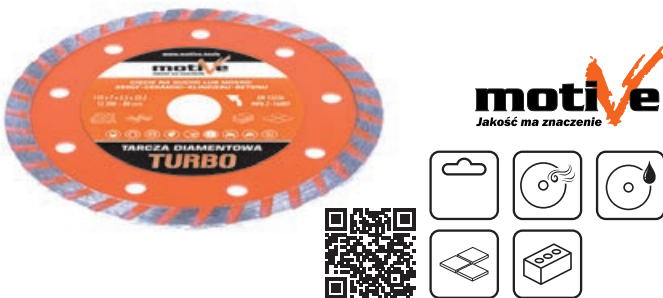

**TARCA DIAMENTOWA TURBO**

Diamond cutting disc • Диск алмазный TURBO • Diamanttrennscheibe Turbo • Disc diamantat Turbo

NUMER KATALOGOWY			
080 108		115 mm	1/50
080 109		125 mm	1/50
080 110		230 mm	1/25

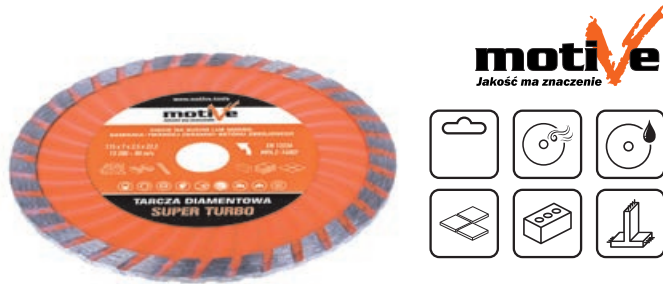

**TARCA DIAMENTOWA SUPER TURBO**

Diamond cutting disc • Диск алмазный SUPER TURBO • Diamanttrennscheibe Super Turbo • Disc diamantat Super Turbo

NUMER KATALOGOWY			
080 111		115 mm	1/50
080 112		125 mm	1/50
080 113		230 mm	1/25

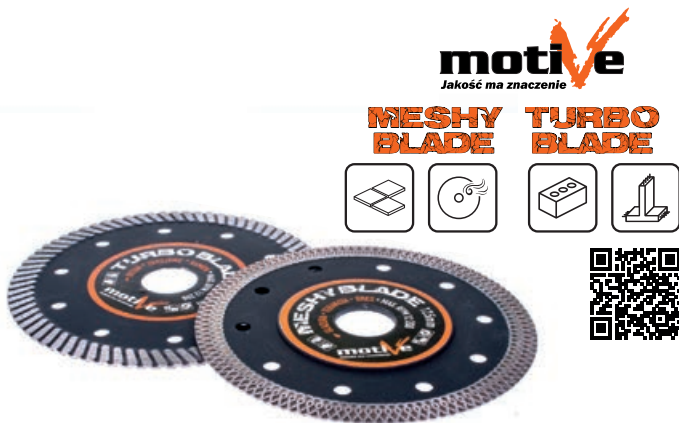

**TARCE DIAMENTOWE TURBO BLADE/MESHY BLADE**

Diamond cutting disc • Диск Meshy Blade/Turbo Blade • Diamanttrennscheibe Meshy Blade/Turbo Blade • Disc diamantat Meshy Blade/Turbo Blade

NUMER KATALOGOWY					
080 184	<b>MESHY BLADE</b>	22,2 mm	1,4 mm	115 mm	1/100
080 185	<b>MESHY BLADE</b>	22,2 mm	1,4 mm	125 mm	1/100
080 186	<b>MESHY BLADE</b>	22,2 mm	1,8 mm	230 mm	1/25
080 187	<b>TURBO BLADE</b>	22,2 mm	2,2 mm	115 mm	1/100
080 188	<b>TURBO BLADE</b>	22,2 mm	2,4 mm	125 mm	1/100
080 189	<b>TURBO BLADE</b>	22,2 mm	2,8 mm	230 mm	1/25



**TARCA DIAMENTOWA UNIWERSALNA SEGMENTOWA**

Diamond cutting disc • Диск алмазный сегментный • Diamanttrennscheibe Segment • Disc diamantat universal

NUMER KATALOGOWY			
080 101		115 mm	1/50/100
080 102		125 mm	1/50/100
080 104		230 mm	1/25/100





**TARCA DIAMENTOWA UNIWERSALNA PEŁNA**

Diamond cutting disc • Диск алмазный • Diamanttrennscheibe für Fliesen  
• Disc diamantat universal



NUMER KATALOGOWY		
080 105	115 mm	1/50/100
080 106	125 mm	1/50/100
080 107	230 mm	1/25

**TARCA DO CIĘCIA STALI NIERDZEWNEJ**

Inox cutting disc • Диск отрезной по нержавеющей стали  
• INOX-Trennscheibe • Disc debitare inox



NUMER KATALOGOWY			
080 181	115 mm	1.0 mm	50/400
080 182	125 mm	1.0 mm	50/400

**TARCA DO CIĘCIA METALU**

Metal cutting disc • Диск отрезной по металлу • Trennscheibe für Metall  
• Disc debitare metale



NUMER KATALOGOWY			
080 168	115 mm	1.0 mm	25/50/400
080 169	125 mm	1.0 mm	25/50/400
080 167	125 mm	1.5 mm	25/50/400
080 175	230 mm	1.8 mm	25/50/400

**ZESTAW WIERTEŁ HSS GOLD BLACK DO METALU**

Drill for metal • Сверло по металлу • Metallbohrer • Burghiu pentru metal



NUMER KATALOGOWY		
080 210	1-10 mm	1/50



**ZESTAW WIERTŁ DO DREWNA**

Drill for wood • Сверло по дереву • Holzbohrer • Burghiu pentru lemn

NUMER  
KATALOGOWY



080 211

4-10 mm

1/25/100



**ZESTAW WIERTŁ SDS DO BETONU**

SDS drill for concrete • Сверло по бетону SDS • SDS Bohrer • Burghiu beton SDS

NUMER  
KATALOGOWY



080 212

6-10 mm

1/40



**ZESTAW WIERTŁ DO METALU**

Drill for metal • Набор сверл по металлу • Metallbohrer Titanium • Burghie metal Titanium

NUMER  
KATALOGOWY



080 239

1-10 mm

1/50



**WIERTŁO DO METALU**

Drill for metal • Сверло по металлу • Metallbohrer Titanium • Burghiu pentru metal

NUMER  
KATALOGOWY



080 240

1.0 mm

10

080 241

1.5 mm

10

080 242

2.0 mm

10

080 243

2.5 mm

10

080 244

3.0 mm

10

080 245

3.2 mm

10

080 246

3.5 mm

10

080 247

4.0 mm

10

080 248

4.5 mm

10

080 249

4.8 mm

10

080 250

5.0 mm

10

080 251

5.2 mm

10

080 252

6.0 mm

10

080 253

6.4 mm

10

080 254

7.0 mm

10

080 255

8.0 mm

10

080 256

9.0 mm

5

080 257

10.0 mm

5

080 258

12.0 mm

5

080 259

14.0 mm

3





**WIERTŁO SDS DO BETONU**

SDS drill for concrete • Сверло по бетону SDS • SDS Bohrer • Burghiu beton SDS

NUMER KATALOGOWY			
080 300	5	110 mm	1/50
080 305	6	160 mm	1/50
080 306	6	210 mm	1/50
080 308	6	310 mm	1/25
080 312	8	160 mm	1/25
080 313	8	210 mm	1/25
080 314	8	260 mm	1/25
080 315	8	310 mm	1/25
080 319	10	160 mm	1/25
080 320	10	210 mm	1/25
080 321	10	260 mm	1/25
080 322	10	310 mm	1/25
080 323	10	350 mm	1/25
080 327	12	160 mm	1/25
080 328	12	210 mm	1/25
080 329	12	260 mm	1/25
080 330	12	310 mm	1/25
080 331	12	350 mm	1/25
080 335	14	160 mm	1/25
080 338	14	310 mm	1/25



**WIERTŁO OTWORNICA**

Hole saw set • Сверло корончатое • Lochsäge, 7 tlg • Fierastrau coroa

NUMER KATALOGOWY		
080 200	26, 32, 38, 45, 50, 56, 63 mm	1/10/60

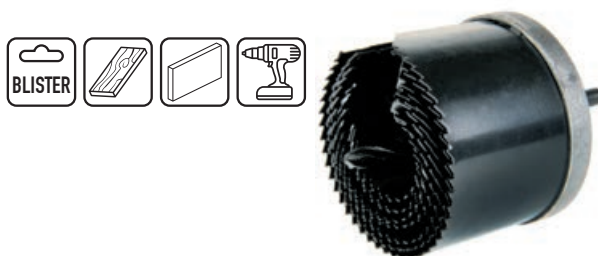

**OTWORNICA DO BETONU Z WOLFRAMEM**

Tungsten carbide grit hole saw with aluminium plate • Корончатое сверло по бетону с вольфрамом • HM-bestreute Lochsäge • Set corote cu wolfram, pentru beton

NUMER KATALOGOWY		
080 190	33, 53, 67, 73 mm	1/10/20



**OTWORNICA DIAMENTOWA**

Brazed Diamond Dry Drill Bit • Сверло-коронка алмазная для керамогранита • Diamant-Lochsäge • Coroana diamantata

NUMER KATALOGOWY		
080 192	6 mm	1/10/20
080 193	8 mm	1/10/20
080 194	12 mm	1/10/20
080 191	25 mm	1/10/20
080 195	35 mm	1/10/20
080 196	50 mm	1/10/20
080 197	55 mm	1/10/20
080 198	65 mm	1/10/20
080 199	75 mm	1/10/20

**motive**  
Jakość ma znaczenie





**motive**  
Jakość ma znaczenie



**WIERTŁO WIELOSTOPNIOWE**

Stepped drill bit • Сверло ступенчатое • Stufenbohrer • Burghiu pas

NUMER  
KATALOGOWY



080 205

4-32 mm

1/10/100



**motive**  
Jakość ma znaczenie



**FREZ DO STYROPIANU**

Cutting mill for styrofoam • Фреза для пенополистирола  
• Styroporfräser • Freza pentru polistiren

NUMER  
KATALOGOWY



080 202

67 mm

100

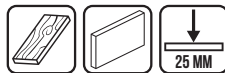

**OTWORNICA DO DREWNA 8 CZĘŚCI**

Hole saw set • Сверло корончатое 8 частей • Lochsäge Set 8-tlg  
• Fierastrau Coroana 8 piese

NUMER  
KATALOGOWY



080 201

64, 76, 89, 102, 127 mm

1/40

# ARTYKUŁY RÓŻNE

РАЗНОЕ • OTHER PRODUCTS • SONTIGES • ACCESORII



# LISTWY PRZYPODŁOGOWE

LP	Symbol	Wymiary listwy	
1	LW1	18 x 40 mm x 2 m	
2	LW1 MINI	14 x 25 mm x 2 m	
3	LW2	12 x 58 mm x 2 m	
4	LW3	14 x 49,5 mm x 2 m	
5	LW4	13 x 78 mm x 2 m	
6	LW5	12,6 x 79 mm x 2 m	
7	LW6	16 x 99 mm x 2 m	
8	LW7	17,7 x 98 mm x 2 m	
9	LW8	26 x 120 mm x 2 m	
10	LW9	22 x 103 mm x 2 m	
11	LW10	15 x 100 mm x 2 m	
12	LW11	11 x 80 mm x 2 m	
13	LW12	19 x 60 mm x 2 m	
14	LW13	8 x 60 mm x 2 m	
15	LW14	15 x 70 mm x 2 m	
16	LKW1	22 x 22 mm x 2 m	



Jeśli chcesz aby w Twoim punkcie znalazły się różnego rodzaju **LISTWY PRZYPODŁOGOWE** to mamy je dla Ciebie! Nasze najnowsze produkty są dostępne w wielu wariantach, umożliwiając dopasowanie ich do każdego wystroju wnętrza.

Aby ułatwić wybór, przygotowaliśmy niewielki, praktyczny wieszany ekspozytor, na którym prezentujemy wszystkie dostępne kształty listew. Daje to możliwość dokładnego przyjrzenia się każdemu detalowi przed podjęciem ostatecznej decyzji.

## **Martwisz się, gdzie znajdziesz na nie miejsce?**

Nie musisz martwić się magazynowaniem listew – przechowujemy je za Ciebie. Dzięki temu możesz zaoszczędzić cenne miejsce i skorzystać z naszej szybkiej dostawy. Zamówione listwy przypodłogowe zostaną dostarczone do Ciebie w terminie od 1 do 5 dni od złożenia zamówienia.



**PIŁA 4-IN-1**

Hand saw 4-in-1 • Ножовка 4-in-1 • Handsägebogen 4 in 1  
• Fierastru pentru taiere metale/lemn

NUMER KATALOGOWY	↔	
090 100	300 mm	1/6/24

**PIŁA DO METALU**

Hand saw for metal • Ножовка по металлу • Metallsäge  
• Fierastru pentru taiere metale

NUMER KATALOGOWY	↔	
090 005	300 mm	1/12/48

**BRZESZCZOT BIMETAL (2 SZT.)**

Bimetal hacksaw blade 2 pcs • Полотно по металлу BIMETAL (2 шт.)  
• Bimetall Sägeblatt (2 Stücke) • Panza bimetal (2 bucăți)

NUMER KATALOGOWY		↔	
090 107	18/inch	300 mm	1/20

**BRZESZCZOTY 2-STR.**

Saw blade - metal 2 sided • Ножовочное полотно двухстороннее  
• Metallsägeblatt doppelseitig • Panza pentru metal

NUMER KATALOGOWY	↔		
090 109	300 mm	50 szt.	1/10

**BRZESZCZOT DO METALU I DREWNA**

Saw blade- wood/metal • Ножовочное полотно металл/дерево  
• Metall/Holz Sägeblatt • Panza de ferastru pentru metal si lemn

NUMER KATALOGOWY	↔		
090 108	300 mm	50 szt.	1/10

**motive**  
Jakość ma znaczenie

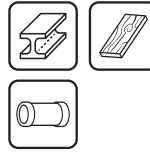

**motive**  
Jakość ma znaczenie





**motive**  
Jakość ma znaczenie

**PIŁA DO GAZOBETONU**

TCT masonry saw • Пила по газобетону • Gasbetonsäge • Fierastrau pentru BCA

NUMER  
KATALOGOWY

090 009

32 zęby / 32 teeth

1/6/12



**motive**  
Jakość ma znaczenie

**PIŁA PŁATNICA**

Hand saw • Пила по дереву • Handsäge • Fierastrau pentru lemn

NUMER  
KATALOGOWY

090 007

450 mm

1/6/24

090 008

500 mm

1/10/120



**motive**  
Jakość ma znaczenie

**PIŁA DO PŁYT GK**

Drywall saw • Пила для гипсокартона • Gipskartonsäge • Fierastrau pentru gipscarton

NUMER  
KATALOGOWY

090 101

1/20/80

**PIŁA DO PŁYT GK**

Drywall saw • Пила для гипсокартона • Gipskartonsäge • Fierastrau pentru gipscarton

NUMER  
KATALOGOWY

090 003

160 mm

1/12/72



**motive**  
Jakość ma znaczenie

**SKRZYŃKA UCIOSOWA Z PIŁĄ**

Heavy duty mitre box with tenon saw • Стусло с пилой • Schneidlade mit Feinsäge • Fierastrau cu suport pentru taiere la unghi

NUMER  
KATALOGOWY

090 104

45°/60°/90°

300 mm

1/20



**SKRZYŃKA UCIOŚOWA Z PIŁĄ**

Mitre box with tenon saw • Стусло с пилой • Sägeset mit Feinsäge und Schneidlade • Fierastrau cu suport pentru taiere la unghi

NUMER  
KATALOGOWY

090 105

45°/90°

300 mm

1/24

**SKRZYŃKA UCIOŚOWA DREWNIANA**

Wooden mitre box • Стусло деревянное • Schneidlade • Suport fierastrau pentru taiere la unghi

NUMER  
KATALOGOWY

090 106

45°/90°

300 mm

1/10

**SKRZYŃKA NARZĘDZIOWA 12"**

Tool box • Ящик для инструмента • Kunststoff - Werkzeugkoffer • Cutie pentru scule

NUMER  
KATALOGOWY

100 359

312 x 167 x 130 mm

1

**SKRZYŃKA NARZĘDZIOWA 16"**

Tool box • Ящик для инструмента • Kunststoff - Werkzeugkoffer • Cutie pentru scule

NUMER  
KATALOGOWY

100 360

415 x 226 x 200 mm

1

**SKRZYŃKA NARZĘDZIOWA 20"**

Tool box • Ящик для инструмента • Kunststoff - Werkzeugkoffer • Cutie pentru scule

NUMER  
KATALOGOWY

100 361

525 x 256 x 246 mm

1



**SKRZYŃKA NARZĘDZIOWA 500 PROFi**

Tool box PROFi • Ящик для инструмента "PROFi" • Kunststoff - Werkzeugkoffer Profi • Cutie pentru scule Profi

NUMER  
KATALOGOWY

100 370

462 x 256 x 242 mm

1

**SKRZYŃKA NARZĘDZIOWA 600 PROFi**

Tool box PROFi • Ящик для инструмента "PROFi" • Kunststoff - Werkzeugkoffer Profi • Cutie pentru scule Profi

NUMER  
KATALOGOWY

100 371

547 x 271 x 278 mm

1

**SKRZYŃKA NARZĘDZIOWA 700 PROFi**

Tool box PROFi • Ящик для инструмента "PROFi" • Kunststoff - Werkzeugkoffer Profi • Cutie pentru scule Profi

NUMER  
KATALOGOWY

100 372

595 x 289 x 328 mm

1

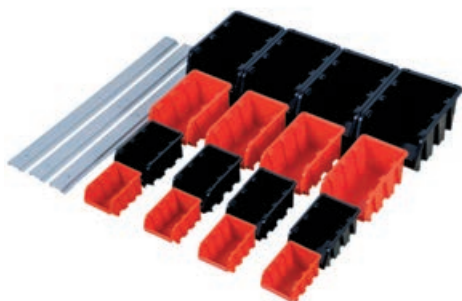
**KUWETA NARZĘDZIOWA 16 SZT + 3 LISTWY**

Plastic storage bins with wall mounting rails • Кювета для инструмента 16 шт + 3 планки • Sichtlagerkästen 16 tlg • Set 16 cutii pentru depozitare

NUMER  
KATALOGOWY

100 375

4	60 x 80 x 115 mm
4	70 x 100 x 155 mm
4	90 x 120 x 195 mm
4	120 x 160 x 230 mm

1

**SKRZYŃKA NA DROBNICĘ**

Plastic container • Ящик для мелочи • Sortierbox • Organizator

NUMER  
KATALOGOWY

100 380

90 x 180 x 35 mm

1

100 381

200 x 160 x 35 mm

1



**SKRZYŃKA NA DROBNICĘ Z UCHWYTEM**

Plastic container with handle • Ящик для мелочи с ручкой • Sortierbox mit Griff  
• Organizer

NUMER KATALOGOWY		
100 385	85 x 245 x 135 mm	1
100 386	85 x 295 x 180 mm	1
100 387	85 x 238 x 359 mm	1
100 388	85 x 298 x 400 mm	1



**ZESTAW BITÓW DO WKREŢARKI 10 SZT.**

Screwdriver bits (10 pcs) • Биты с магнитом (10 шт.) • Schrauberbit Set 10-teilig  
• Biti pentru insurubare (10 bucati)

NUMER KATALOGOWY			
100 321	PH1 x 2, PH2 x 2, PZ1 x 2, PZ2 x 2, SL5 x 1, SL6 x 1	25 mm	1/100/200



**BITY DO WKREŢARKI 5 SZT.**

Screwdriver bits (5 pcs) • Биты с магнитом (5 шт.) • Schrauberbit Set (5-teilig)  
• Biti pentru insurubare (5 bucati)

NUMER KATALOGOWY			
100 322	PH1	25 mm	1/100/200
100 323	PH1	50 mm	1/100/200
100 324	PH2	25 mm	1/100/200
100 325	PH2	50 mm	1/100/200
100 326	PH3	25 mm	1/100/200
100 327	PH3	50 mm	1/100/200
100 328	PZ1	25 mm	1/100/200
100 329	PZ1	50 mm	1/100/200
100 330	PZ2	25 mm	1/100/200
100 331	PZ2	50 mm	1/100/200
100 332	PZ3	25 mm	1/100/200
100 333	PZ3	50 mm	1/100/200



**BITY PH2 Z OGRANICZNIKIEM**

Plasterboard bits • Биты с ограничителем • Bits für Gipskarton mit Tiefenstopp  
• Biti pentru gips carton

NUMER KATALOGOWY		
100 334	25 mm	1/100/200





**motive**  
Jakość ma znaczenie

**UCHWYT MAGNETYCZNY DO BITÓW**

Bit holder with magnet • Магнитный держатель для бит • Magnet Bithalter  
• Prelungitor magnetic pentru biti de insurubare

NUMER  
KATALOGOWY



100 335

60 mm

1/100/200



**motive**  
Jakość ma znaczenie

**PODPORA TELESKOPOWA**

Extension support • Телескопическая опора • Teleskopstütze  
• Suport telescopic

NUMER  
KATALOGOWY

MAX:



090 830

60 kg

0,7 m - 1,15 m

1/6

090 831

60 kg

1,6 m - 2,9 m

1/6



**motive**  
Jakość ma znaczenie

**OŁÓWEK STOLARSKI**

Carpenter pencil • Столярный карандаш • Zimmermannsbleistift  
• Creion tamplarie

NUMER  
KATALOGOWY



090 041

1/50



**motive**  
Jakość ma znaczenie

**OŁÓWEK MURARSKI**

Bricklayer pencil • Карандаш каменщика • Maurerbleistift • Creion zidar

NUMER  
KATALOGOWY



090 042

1/50



**motive**  
Jakość ma znaczenie

**OŁÓWEK DO SZKŁA I GLAZURY**

Pencil for glass and glaze • Карандаш для стекла и плитки • Fliesenbleistift "T"  
• Creion sticla si ceramica

NUMER  
KATALOGOWY



090 043

1/50

**OŁÓWEK DO MOKRYCH POWIERZCHNI KB MOTIVE**Pencil for wet surfaces • Карандаш для мокрых поверхностей  
• Bleistift für nasse Oberflächen • Creion trasare suprafete umede si lucioaseNUMER  
KATALOGOWY

090 068

1/50

**OŁÓWEK STOLARSKI DWUPAK**Carpenter pencil x2 • Столярный карандаш x2 • Zimmermannsbleistift x2  
• Creion tamplarieNUMER  
KATALOGOWY

090 067

1/36

**OŁÓWEK STOLARSKI**Carpenter pencil • Столярный карандаш • Zimmermannsbleistift  
• Creion tamplarieNUMER  
KATALOGOWY

090 040

50/600/1200

**TEMPERÓWKA DO OŁÓWKÓW STOLARSKICH**Pencil sharpener • Точилка для карандашей • Anspitzer für  
Zimmermannsbleistifte • Ascuțitoare creioane tamplarieNUMER  
KATALOGOWY

090 039

1/100/800

**MARKER PERMANENTNY**

Marker • Перманентный маркер • Permanentmarker • Marker permanent

NUMER  
KATALOGOWY

100 110



1/10

100 111



1/10

100 112



1/10

100 113



1/10

100 114



1/10

**motive**  
Jakość ma znaczenie**motive**  
Jakość ma znaczenie**motive**  
Jakość ma znaczenie

**MARKER PERMANENTNY DWUSTRONNY**

Twin tip permanent marker • Перманентный маркер • Marker mit zwei Spitzen  
• Marker permanent cu 2 capete

NUMER  
KATALOGOWY



100 119

1/10/1000

**MARKER OLEJOWY BIAŁY**

Oil-based paint marker white • Маркер масляный белый • Ölmarker weiß  
• Marker alb pe baza de ulei

NUMER  
KATALOGOWY



100 117

1/10/1000

**MARKER OLEJOWY BIAŁY**

Oil-based paint marker • Маркер масляный белый • Öl basierte Paint Marker  
• Marker alb pe baza de ulei

NUMER  
KATALOGOWY



000216

1/12/144

**KREDA BUDOWLANA**

Marking crayon • Мелок строительный • Krits vaska • Signierkreide • Cretă  
forestieră și pentru semnat

NUMER  
KATALOGOWY



090 062

10

090 063

10

090 064

10

**KREDA TRASERSKA 115 G**

Chalk line powder 115 g • Трассировочный мел 115 гр  
• Schlagschnurpulver 115 g • Praf creta 115 g

NUMER  
KATALOGOWY



090 065

1/10/100

090 066

1/10/100

**SZNR TRASERSKI FAST**Chalk line FAST • Трассировочный шнур FAST • Schlagschnur  
• Dispozitiv de trasat ata cu creta

NUMER KATALOGOWY		
090 057	30 m	1/10

**SZNR TRASERSKI**

Chalk line • Трассировочный шнур • Schlagschnur • Dispozitiv de trasat cu fir

NUMER KATALOGOWY		
090 054	30 m	1/10/100

**SZNR TRASERSKI ABS**Chalk line ABS • Трассировочный шнур ABS • Schlagschnur ABS  
• Dispozitiv de trasat cu fir ABS

NUMER KATALOGOWY		
090 056	30 m	1/10/100

**MIARA DUO-SCALE MAGNETIC**Double sided measuring tape • Рулетка • Doppelseitiges Maßband mit Magnet  
• Ruleta cu două fețe

NUMER KATALOGOWY			
090 080	28 mm	5 m	1/6/72

**MIARA DUO-SCALE HOOK**Double sided measuring tape • Рулетка • Doppelseitiges Maßband  
• Ruleta cu două fețe

NUMER KATALOGOWY			
090 085	25 mm	5 m	1/6/72

**motive**  
Jakość ma znaczenie**motive**  
Jakość ma znaczenie

CLASS II

**motive**  
Jakość ma znaczenie

CLASS II





**motive**   
Jakość ma znaczenie

CLASS II

**MIARA ABS**

Measuring tape ABS • Рулетка • Bandmaß ABS • Ruleta ABS

NUMER  
KATALOGOWY

090 076

25 mm

5 m

1/6/72



**motive**   
Jakość ma znaczenie

CLASS II

**MIARA STALOWA**

Measuring tape • Рулетка • Bandmaß • Ruleta metalica

NUMER  
KATALOGOWY

090 074

25 mm

5 m

1/6/72



**motive**   
Jakość ma znaczenie

CLASS II

**MIARA STALOWA AUTO-LOCK**

Measuring tape AUTO-LOCK • Рулетка AUTO-LOCK • Bandmaß AUTO-LOCK • Ruleta Auto-Lock

NUMER  
KATALOGOWY

090 075

25 mm

5 m

1/6/72



**motive**   
Jakość ma znaczenie

CLASS II

**MIARA STALOWA**

Steel measuring tape • Рулетка металлическая • Bandmaß Edelstahlgehäuse • Ruleta metalica

NUMER  
KATALOGOWY

090 071

15 mm

3 m

1/12

090 072

20 mm

5 m

1/12

090 073

25 mm

8 m

1/6



**motive**   
Jakość ma znaczenie

CLASS II

**MIARA AUTO-LOCK**

Auto-lock measuring tape • Рулетка AUTO-LOCK • Bandmaß Auto-Lock • Ruleta Auto-Lock

NUMER  
KATALOGOWY

090 025

15 mm

3 m

1/12/120

090 026

20 mm

5 m

1/12/96

090 027

25 mm

8 m



1/6/48





**MIARA ZWIJANA SOFT**

Measuring tape soft grip case • Рулетка SOFT • Bandmaß SOFT • Ruleta Soft

NUMER KATALOGOWY			
090 033	15 mm	2 m	1/12/120
090 034	15 mm	3 m	1/12/120
090 035	20 mm	5 m	1/12/120
090 036	25 mm	8 m	1/6/60
090 037	25 mm	10 m	1/6/60



**MIARA DREWNIANA**

Wooden folding ruler • Метр деревянный • Gliedemaßstab • Metru lemn

NUMER KATALOGOWY		
090 013	2 m	1/10/200

**TAŚMA MIERNICZA WBIJANA**

Open reel fibreglass tape • Рулетка геодезическая • Fiberglas Bandmaß • Ruleta

NUMER KATALOGOWY		
090 017	30 m	1/24
090 018	50 m	1/16





**TAŚMA MIERNICZA**

Fiberglass measure tape • Рулетка геодезическая • Fiberglas Bandmaß • Ruleta

NUMER KATALOGOWY		
090 019	30 m	1/60

**SZNUR MURARSKI**

Mason's line • Шнур каменщика • Maurerschnur • Sfoară zidărie

NUMER KATALOGOWY				
090 050	Green	50 m	1,2 mm	1/12/144
090 051	Green	50 m	1,7 mm	1/12/144
090 052	Red	100 m	1,2 mm	1/6/144
090 053	Red	100 m	2 mm	1/6/144

**motive**   
Jakość ma znaczenie



**motive**   
Jakość ma znaczenie



**motive**   
Jakość ma znaczenie



**motive**   
Jakość ma znaczenie



**motive**   
Jakość ma znaczenie



**SZNUREK POLIPROPYLENOWY**Polypropylene twine • Шнур полипропиленовый • PP-Kordel  
• Sfoara polipropilena

NUMER KATALOGOWY		kg		
090 055		0,5 kg	(500 m +/- 8%)	1/10
090 049		UV 1 kg	1200 m	1/10

 **motive**   
Jakość ma znaczenie**ŻYŁKA GOSPODARCZA**General purpose nylon line • Хозяйственная леска  
• Synthetischer Maurerschnur • Sfoară zidărie gută

NUMER KATALOGOWY			
090 059	1,3 mm	100 m	1/50

**ŻYŁKA GOSPODARCZA**General purpose nylon line • Хозяйственная леска  
• Synthetischer Maurerschnur • Sfoară zidărie gută

NUMER KATALOGOWY			
090 060	0,8 mm	100 m	1/100

 **motive**   
Jakość ma znaczenie**WYCISKACZ HD**Caulking gun HD • Пистолет для герметиков HD • Kartuschenpistole HD  
• Pistol silicon HD

NUMER KATALOGOWY		
090 165	300 ml	1/12

 **motive**   
Jakość ma znaczenie**WYCISKACZ STRONG**Caulking gun STRONG • Пистолет для герметиков STRONG  
• Kartuschenpistole "Strong" • Pistol silicon Strong

NUMER KATALOGOWY		
090 160	300 ml	1/12

**WYCISKACZ PROFI**PROFI caulking gun • Пистолет для герметиков PROFI  
• Kartuschenpistole Profi • Pistol silicon Profi

NUMER KATALOGOWY		
090 125	300 ml	1/12

**WYCISKACZ DO SILIKONU**

Caulking gun • Пистолет для герметиков • Kartuschenpistole • Pistol silicon

NUMER KATALOGOWY		
090 127	300 ml	1/12

**WYCISKACZ DO MAS USZCZELNIAJĄCYCH**Tube caulking gun • Пистолет для герметиков • Auspresspistole Alu  
• Presa silicon tip salam

NUMER KATALOGOWY		
090 119	300 ml	1/12
090 118	600 ml	1/12

**WYCISKACZ DO SILIKONU SZKIELETOWY**Skeleton caulking gun • Скелетный пистолет для герметиков  
• Kartuschenpistole • Pistol silicon

NUMER KATALOGOWY		
090 121	300 ml	1/12

**WYCISKACZ DO SILIKONU**Caulking gun • Полукопусный пистолет для герметиков  
• Kartuschenpistole • Pistol silicon

NUMER KATALOGOWY		
090 120	300 ml	1/12

**motive**  
Jakość ma znaczenie**motive**  
Jakość ma znaczenie**motive**  
Jakość ma znaczenie

**WYCISKACZ PLASTIKOWY**Plastic caulking gun • Пистолет для герметиков пластмассовый  
• Kartuschenpistole Plastik • Pistol silicon plasticNUMER  
KATALOGOWY

090 124

300 ml

1/12

**KOŃCÓWKI WYCISKACZA DO MAS**Tube caulking gun spare nozzles • Наконечники к пистолету для герметиков  
• Ersatzspitzen für Auspresspistole • Duze pistol siliconNUMER  
KATALOGOWY

090 117

10/500

**motive**  
Jakość ma znaczenie

PTFE

**PISTOLET DO PIANKI MONTAŻOWEJ**PTFE coated pu foam gun • Пистолет для монтажной пены с тефлоновым  
покрытием • PU Schaumpistole • Pistol pentru spuma poliuretanică PTFENUMER  
KATALOGOWY

090 128

1/20

**PISTOLET DO PIANKI MONTAŻOWEJ**PU foam gun • Пистолет для монтажной пены • PU Schaumpistole  
• Pistol pentru spuma poliuretanicăNUMER  
KATALOGOWY

090 126

1/20

**PISTOLET DO PIANKI MONTAŻOWEJ MINI**Mini PU foam gun • Пистолет для монтажной пены MINI  
• PU Schaumpistole Mini • Pistol pentru spuma poliuretanicăNUMER  
KATALOGOWY

090 129

1/100

**motive**  
Jakość ma znaczenie

BLISTER

**ZSZYWACZ TAPICERSKI PROFI**

Staple gun PROFİ • Степлеп PROFİ • Handtacker Profi • Capsator tapiterie Profi

NUMER  
KATALOGOWY

090 131

4-14 mm

1/10/40



**ZSZYWACZ TAPICERSKI**

Staple gun • Степлер • Handtacker • Capsator tapiterie



NUMER  
KATALOGOWY



090 130

4-14 mm

1/10/40

**ZSZYWKA (1000 SZT.)**

Staples (1000 pcs) • Скобы для степлера (1000 шт.)  
• Tackerklammern (1000 Stück) • Capse tapiterie (1000 bucaci)



NUMER  
KATALOGOWY



090 141

6 mm

1/50/200

090 142

8 mm

1/50/200

090 143

10 mm

1/50/200

090 144

12 mm

1/50/200

090 145

14 mm

1/50/200

**USZCZELKA**

EPDM Rubber weatherstrip seal • Уплотнитель для окон  
• Selbstklebende Dichtung • Banda de etansare ferestre

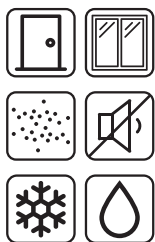

NUMER  
KATALOGOWY



090 200

100 m

1/6

090 201

100 m

1/6

090 202

100 m

1/6

090 203

100 m

1/6

090 204

150 m

1/6

090 205

150 m

1/6

090 211

6 m

1/36

090 212

6 m

1/36

090 209

6 m

1/36

090 210

6 m

1/36

090 213

6 m

1/36

090 214

6 m

1/36



**USZCZELKA PU**

Foam seal • Паролон для утепления окон тип "PU" • Schaumstoffdichtung PU  
• Banda autoadeziva pentru etansare din burete

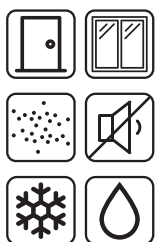

NUMER  
KATALOGOWY



090 206

PU 1

6 m

5 mm

9 mm

1/100

090 207

PU 2

6 m

8 mm

10 mm

1/200

090 208

PU 3

5 m

10 mm

12 mm

1/100

**PASY TRANSPORTOWE**Ratchet tie down • Ленты для крепления груза • Spanngurt  
• Chinga de ancoraj cu clichet si carlig

NUMER KATALOGOWY					
090 300	3.8 m	25 mm	270 kg	540 kg	1/30
090 301	3.8 m	27 mm	500 kg	1000 kg	1/20
090 302	3 m	27 mm	600 kg	1200 kg	1/20
090 303	3.8 m	38 mm	1000 kg	2000 kg	1/20
090 304	6 m	50 mm	2500 kg	5000 kg	1/10
090 305	6.8 m	50 mm	2500 kg	5000 kg	1/10
090 306	8 m	50 mm	2500 kg	5000 kg	1/10
090 307	10 m	50 mm	2500 kg	5000 kg	1/10
090 308	12 m	50 mm	2500 kg	5000 kg	1/10

**motive**  
Jakość ma znaczenie**KŁÓDKA MOSIĘŻNA**

Brass padlock • Замок латунный • Pakabinama spyna, žalvarinė • Messing-Vorhängeschloss

NUMER KATALOGOWY		
090 601	40 mm	1/12/300
090 602	50 mm	1/12/120
090 603	60 mm	1/12/120

**KŁÓDKA ŻELIWNA**Iron padlock • Чугунный висячий замок • Vorhängeschloss aus Gusseisen  
• Lacat din fier

NUMER KATALOGOWY		
090 621	40 mm	1/12/96
090 622	50 mm	1/12/72
090 623	60 mm	1/12/48
090 624	75 mm	1/12/24

**KŁÓDKA TRZPIENIOWA WZMOCNIONA**Brass rectangular padlock • Стержневой латунный висячий замок  
• Monoblock-Vorhängeschloss • Lacat dreptunghiular

NUMER KATALOGOWY		
090 610	70 mm	1/6/48
090 611	80 mm	1/6/48
090 612	90 mm	1/6/36

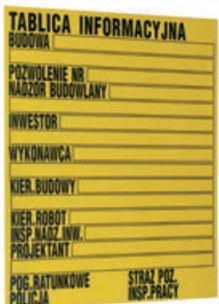
**TABLICA INFORMACYJNA**

Information signboard • Доска строительная • Bautafel • Panou santier

NUMER KATALOGOWY		
090 630	700 x 900 mm	1/50
090 629	500 x 700 mm	1/50

**PRÓBNIK ELEKTRYCZNY**Voltage tester screwdriver • Индикатор напряжения-отвертка  
• Spannungsprüfer • Surubelnita dreapta creion de tensiune

NUMER KATALOGOWY	V	
100 320	110 - 250	1/24

**NAŚWIETLACZ LED**

Led fixture • Светодиодный прожектор • LED Strahler • Projector LED



NUMER KATALOGOWY	W	V/Hz			
090 730	10 W	230 / 50	4000 K	1/24	
090 731	20 W	230 / 50	4000 K	1/16	
090 732	30 W	230 / 50	4000 K	1/12	
090 737	50 W	230 / 50	6500 K	1/8	
090 745	uchwyt/handle	30 W	230 / 50	4000 K	1/4

**NAŚWIETLACZ LED**

Led fixture • Светодиодный прожектор • LED Strahler • Projector LED



NUMER KATALOGOWY	W	V/Hz			
090 740	STATYW	30 W	230 / 50	4000 K	1/4
090 743	STATYW	2 x 50 W	230 / 50	4000 K	1

**PRZEDŁUŻACZ BĘBNOWY**Extension reel, 4 sockets • Удлинитель катушечный • Kabeltrommel  
• Derulator cablu electric

NUMER KATALOGOWY				V/Hz	V/A MAX	
090 690	4	1.5 mm	50 m	230 / 50	250 / 16	1/2
090 691	4	1.5 mm	30 m	230 / 50	250 / 16	1/4
090 692	4	2.5 mm	30 m	230 / 50	250 / 16	1/4



**PRZEDŁUŻACZ JEDNOGNIAZDOWY**Extension lead • Удлинитель огородный • Verlängerungskabel  
• Prelungitor cu fisa si cupla, contact de protectie

NUMER KATALOGOWY			V/Hz	V/A MAX	
090 696	1.5 mm	25 m	230 / 50	250 / 16	1/6
090 697	1.5 mm	40 m	230 / 50	250 / 16	1/4

**motive**  
Jakość ma znaczenie**PISTOLET KLEJOWY**

Glue gun • Пистолет для клея • Heißklebepistole • Pistol de lipit

NUMER KATALOGOWY	V/Hz	W	
090 223	230 / 50	120	1/10

**motive**  
Jakość ma znaczenie**WKŁADY KLEJOWE (10 SZT.)**

Glue sticks (10 pcs) • Клеевые вкладыши (10 шт.) • Klebestangen für Klebepistole (10 Stück) • Baghete silicon pentru pistolul de lipit (10 buc)

NUMER KATALOGOWY			
090 224	11,2 mm	200 mm	10/60

**PISTOLET KLEJOWY**

Glue gun • Пистолет для клея • Heißklebepistole • Pistol de lipit

NUMER KATALOGOWY	V/Hz	W	
090 221	230 / 50	20 W	1/24

**WKŁADY KLEJOWE (50 SZT.)**

Glue sticks (50 pcs) • Клеевые вкладыши (50шт.) • Klebestangen für Klebepistole (50 Stück) • Baghete silicon pentru pistolul de lipit (50 buc)

NUMER KATALOGOWY			
090 222	11,2 mm	200 mm	1/10/50



**OPASKI ZACISKOWE CZARNE**Fixing ties, black • Хомуты пластиковые черные • Kabelbinder schwarz  
• Colier cablu negruNUMER  
KATALOGOWY

090 661	2,5 x 150 mm (100 szt.)	1/125/250
090 663	3,6 x 150 mm (100 szt.)	1/125/250
090 665	3,6 x 200 mm (100 szt.)	1/125/200
090 667	3,6 x 250 mm (100 szt.)	1/125/200
090 669	4,8 x 200 mm (100 szt.)	1/50/100
090 671	4,8 x 300 mm (100 szt.)	1/50/100
090 673	4,8 x 350 mm (100 szt.)	1/90
090 675	4,8 x 450 mm (100 szt.)	1/70
090 677	9,0 x 550 mm (50 szt.)	1/40
090 679	9,0 x 760 mm (50 szt.)	1/20

**OPASKI ZACISKOWE BIAŁE**Fixing ties, white • Хомуты пластиковые белые • Kabelbinder weiß  
• Colier cablu albNUMER  
KATALOGOWY

090 660	2,5 x 150 mm (100 szt.)	1/125/250
090 662	3,6 x 150 mm (100 szt.)	1/125/250
090 664	3,6 x 200 mm (100 szt.)	1/125/200
090 666	3,6 x 250 mm (100 szt.)	1/125/250
090 668	4,8 x 200 mm (100 szt.)	1/50/100
090 670	4,8 x 300 mm (100 szt.)	1/50/100
090 672	4,8 x 350 mm (100 szt.)	1/90
090 674	4,8 x 450 mm (100 szt.)	1/70
090 676	9,0 x 550 mm (50 szt.)	1/40
090 678	9,0 x 760 mm (50 szt.)	1/20





# NARZĘDZIA I AKCESORIA STOLARSKIE

СТОЛЯРНЫЙ ИНСТРУМЕНТ И АКЦЕССУАРЫ • WOODWORKING TOOLS

• TISCHLERWERKZEUG • UNELTE PENTRU PRELUCRAT LEMN





# KĄTOWNIK STOLARSKI DO ZACISKANIA



## KĄTOWNIK STOLARSKI DO ZACISKANIA

to kolejne niezbędne akcesorium na wyposażeniu warsztatu domowego lub stolarskiego. Służy do stabilizacji kąta prostego podczas klejenia i montażu m.in. szafek, szuflad, czy ramek. Jest bardzo wygodny w użytkowaniu. Dotyczy to zarówno przymiaru kątownika do zewnętrznych, jak i wewnętrznych narożników. Kątownik jest odporny na mechaniczne uszkodzenia i pęknięcia, co świadczy o jego solidnym wykonaniu. Nie podlega praktycznie żadnej deformacji.

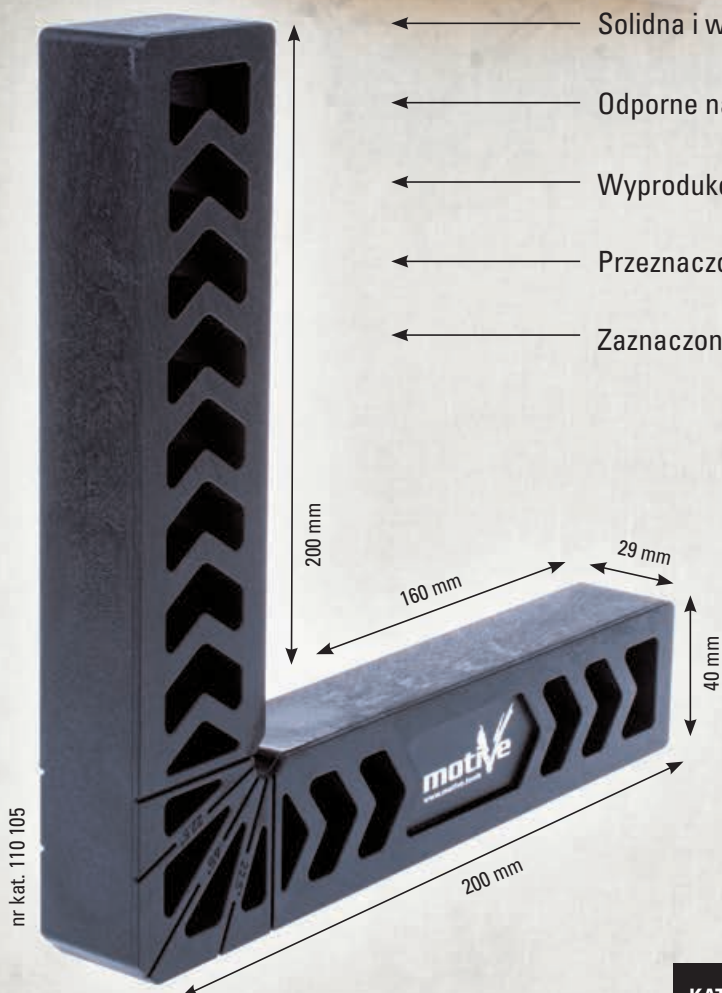

nr kat. 110 105

- ← Solidna i wytrzymała konstrukcja z poliwęglanu
- ← Odporne na mechaniczne uszkodzenia tworzywo
- ← Wyprodukowany z dużą dokładnością i starannością
- ← Przeznaczony do pracy również z silnymi ściskami stolarskimi
- ← Zaznaczone po obu stronach kątownika kąty: 22,5° i 45°

**HEAVY  
DUTY**



Zaokrąglone zagłębienie wewnątrz ułatwiające dokładniejsze spasowanie łączonych elementów

## KĄTOWNIK STOLARSKI DO ZACISKANIA

90 degree clamping square • Угольник столярный монтажный  
• Spannwinkel • Echer tamplarie



NUMER  
KATALOGOWY

110 105



200 x 200 mm



1/40

# ŚCISK PEŁNOPOWIERZCHNIOWY

AKCESORIA  
I NARZĘDZIA  
STOLARSKIE



HEAVY  
DUTY



90 mm

Bardzo głęboki chwyt

**ŚCISKI PEŁNOPOWIERZCHNIOWE** to fachowe i niezawodne przyrządy niezbędne w każdym warsztacie. Dedykowane są zarówno profesjonalistom, jak i majsterkowiczom. Dzięki nim możesz ścisnąć i unieruchomić sklepane ze sobą elementy. Z powodzeniem również stabilnie zamocujesz do blatu lub stołu praktycznie każdy materiał podczas jego obróbki. Korzystając z kolej z opcji rozpirającej możesz np. właściwie ustawić i unieruchomić ościeżnicę, podczas jej piankowania. Nasze ściski przydatne są do wszelkich prac wymagających użycia znacznych sił statycznych. Polecamy!



## ŚCISK PEŁNOPOWIERZCHNIOWY

Bar clamp gun • Зажим плотника пистолетного типа  
• Einhandzwinde • Menghina de man

NUMER  
KATALOGOWY



110 100	450 mm	1/6
110 101	600 mm	1/6
110 102	900 mm	1/6



# ZACISKOWE LISTWY PROWADZĄCE

**motive**



**Chcesz przyciąć płytę dożądanego wymiaru?  
Nie masz odpowiedniej listwy?**

**Skorzystaj z naszych listew prowadzących.  
Do wyboru masz dwie serie listew o różnych długościach.**

Te uniwersalne listwy, dostępne w trzech długościach mogą być użyte z każdą piłą tarczową, zagłębiarką, wyrzynarką, czy też frezarką. Przy ich pomocy z łatwością przytniesz płytę meblową, OSB, sklejkę albo drewniany blat. Używając natomiast nożyka lub piły ręcznej dotniesz również arkusz PCV, czy płytę karton-gips. Listwy posłużyc mogą do wyznaczania linii, a zaciśnięte na blacie spełnią funkcję przymiaru lub zderzaka.

## SERIA LISTEW Z DOSTĘPNYMI PRZEDŁUŻKAMI



### LISTWY PODSTAWOWE

Clamp cutting guide • Планка-направляющая  
• Führungsschiene • Riglă de ghidare

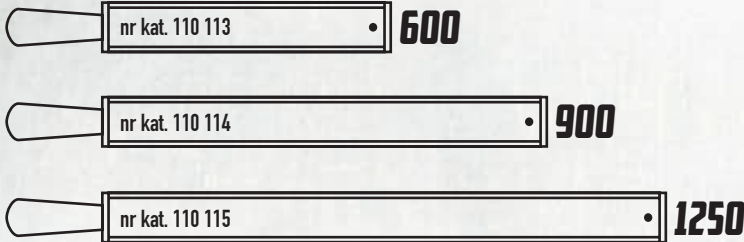

### LISTWY PRZEDŁUŻAJĄCE

Cutting guide extension • Удлинитель столярной направляющей  
с зажимами • Verlängerung für Führungsschiene • Riglă de ghidare

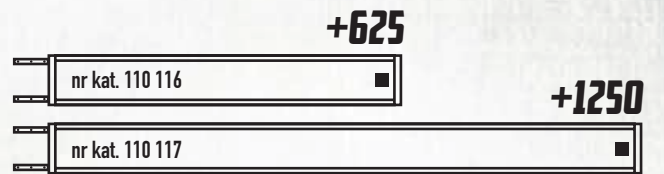

## SERIA WĘŻSZYCH LISTEW Z WYCHYLNymi ZACISKAMI, BEZ MOŻLIWOŚCI PRZEDŁUŻANIA

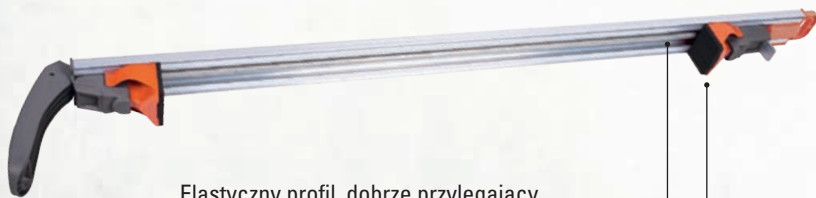

### LISTWY PODSTAWOWE

Clamp cutting guide • Планка-направляющая  
• Führungsschiene • Riglă de ghidare

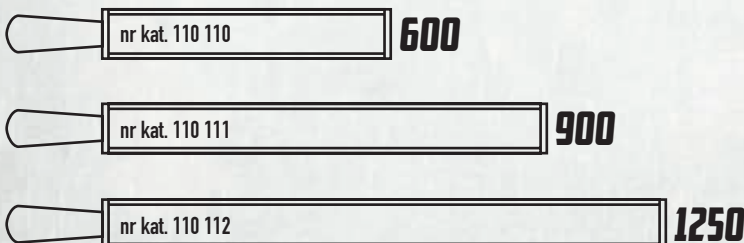

Stalowy pręt wzmacniający

Wychylne na boki zaciski ułatwiające cięcie nieforemnych płyt

Kilkustopniowa siła zacisku





**motive**   
Jakość ma znaczenie



**ŚCISK STOLARSKI SPRĘŻYNOWY**

Spring clamp • Зажим плотника пружинный • Leimklemme  
• Menghina de mana

NUMER KATALOGOWY	kg		
090 801	12 kg	max 50 mm	1/240
090 802	15 kg	max 63 mm	1/120
090 803	17 kg	max 75 mm	1



**motive**   
Jakość ma znaczenie



**ŚCISK STOLARSKI ŚRUBOWY**

F Type clamp • Зажим плотника винтовой • Schraubzwinge  
• Menghina cu surub, din fonta

NUMER KATALOGOWY			
090 810	50 mm	100 mm	1/50
090 811	50 mm	200 mm	1/50
090 812	80 mm	200 mm	1/30
090 813	80 mm	300 mm	1/30
090 814	120 mm	300 mm	1/20
090 815	120 mm	500 mm	1/12



**motive**   
Jakość ma znaczenie



**ŚCISK STOLARSKI PISTOLETOWY**

Bar clamp • Зажим плотника пистолетного типа • Einhandzwinge  
• Menghina de mana

NUMER KATALOGOWY		
090 820	max 100 mm	1/100
090 821	max 150 mm	1/12
090 822	max 300 mm	1/12



**motive**   
Jakość ma znaczenie



**KAŹOWNIK STOLARSKI ALUMINIOWY**

Metal angle ruler • Угломер металлический • Bauwinkel • Echer tamplarie

NUMER KATALOGOWY		
110 120	300 mm x 300 mm	1



**KAŹOWNIK STOLARSKI**

Carpenter angle ruler • Угломер столярный • Schreinerwinkel • Echer tamplarie

NUMER KATALOGOWY		
040 814	350 mm	1/12/60



# NARZĘDZIA BIHUI

ИНСТРУМЕНТЫ • TOOLS

WERKZEUGE • UNELTE





**SYSTEM PRZYSSAWEK DO PRZENOSZENIA PŁYTEK**  
 Classic Carrier System • Классическая несущая система • Klassisches Trägersystem • Sistem de transport cu 4 ventuze cu vacuum

 NUMER  
 KATALOGOWY





LFCSV4

130 kg

320 x 160 cm

1



**STOLIK GLAZURNICZY SKŁADANY**  
 Working Bench • Рабочий стол • Werkbank • Masa de lucru

 NUMER  
 KATALOGOWY





LFFT

300 kg

70 cm

221 x 113 cm

1



**STOLIK GLAZURNICZY SKŁADANY**  
 Working Bench • Рабочий стол • Werkbank • Masa de lucru

 NUMER  
 KATALOGOWY





LFWB

200 kg

80 cm

180 x 140 cm

1



**STÓŁ GLAZURNICZY Z PROWADNICĄ OBROTOWĄ**  
 Working Bench • Рабочий стол • Werkbank • Masa de lucru

 NUMER  
 KATALOGOWY





TWT900

200 kg

78 cm

100 x 40 cm

1



**SYSTEM DO CIĘCIA PŁYTEK**  
 Mitre Jolly Cutting System • Отзывы о электрическом плиткорезе • Sistem de taiere

 NUMER  
 KATALOGOWY







LFMBF

1200W

230V

45-48°

1



**AUTOMATYCZNA PRZECINARKA DO GLAZURY**  
 Automatic multifunctional cutting machine • Автоматический электрический плиткорез • Automatische elektrische Fliesenschneidemaschine • Mașină electrică automată de tăiat gresie

 NUMER  
 KATALOGOWY







TCSA1200

3000W

230V

120 cm

1

**MANUALNA MASZYŃKA NA SYSTEMIE SZYNOWYM DO CIĘCIA PŁYT WIELKOFORMATOWYCH**

Manual Cutting System • Система ручной резки • Manuelles Schneidsystem • Sistem de tăiere manual

NUMER KATALOGOWY		
LFMCS	320 cm	1

**BIHUI**



**MANUALNA MASZYŃKA NA SYSTEMIE SZYNOWYM DO CIĘCIA PŁYT WIELKOFORMATOWYCH**

Manual Cutting System • Система ручной резки • Manuelles Schneidsystem • Sistem de tăiere manual

NUMER KATALOGOWY		
LFMCS5	320 cm	1

**BIHUI**



**ŁAMAK DO PŁYT WIELKOFORMATOWYCH**

Tile Breaking Clamp • Зажим для тяжелого режима работы с плиткой • Schwerlast-Fliesenbrechklemme • Clemă de rupere a plăcilor grele

NUMER KATALOGOWY		
LFTBD	3 - 15 mm	1

**BIHUI**



**MASZYŃKA DO CIĘCIA PRĘYTEK**

Tile cutter • Плиткорез ручной • Fliesenschneider • Masina de taiat faianta

NUMER KATALOGOWY		
TCB800	800 mm	1
TCB1000	1000 mm	1
TCB1200	1200 mm	1

**BIHUI**



**KÓŁKO TNĄCE**

Tile cutter wheel • Запасной ролик • Ersatz Schneidrad • Rola schimb

NUMER KATALOGOWY		
TCB-SW	22 mm	1/12/60

**BIHUI**



**DOBIJAK DO PŁYTEK Z PRZYSSAWKĄ I WYŚWIETLACZEM**

Vibration tile beater • Вибрационный битер для плитки • Vibrations-Fliesenschläger • Vibrator profesional cu ventuza

NUMER KATALOGOWY		
LFTBA	35 kg	1000/min. 1

**BIHUI**



**DOBIJAK DO PŁYTEK Z PRZYSSAWKĄ**

 Vibration tile beater • Вибрационный битер для плитки  
 • Vibrations-Fliesenschläger • Vibrator profesional cu ventuza

 NUMER  
KATALOGOWY

LFTBV

35 kg

1000/min.

1

**PŁYTA DO DOBIJAKA**

 Tile beater PE board • Платформа для виброприсоски  
 • Forma pentru vibratoare placi

 NUMER  
KATALOGOWY

LFTBV-BB

260 x 180 mm

1/20

**ZESTAW DO REGULACJI FUG**

 Tile Gap Regulator • Выберите регулятор зазора плитки • Wählen Sie Tile Gap  
 Regulator • Sistem de fixare si ajustare pt. placi ceramice

 NUMER  
KATALOGOWY

LFTSA8

0.5 - 40 mm

1

LFTSA-FRM

rama/frame

1

**ZESTAW DO REGULACJI FUG**

 Tile Gap Regulator • Выберите регулятор зазора плитки • Wählen Sie Tile Gap  
 Regulator • Sistem de fixare si ajustare pt. placi ceramice

 NUMER  
KATALOGOWY

LFTSB6

0.5 - 40 mm

1

LFTSB6-PG

tok/plunger

1

**PRZYSSAWKA Z AKUMULATOREM**

 Vacuum suction cup • Вакуумная присоска для плитки и стекла с  
 манометром • Vakuum Saugheber mit Manometer • Ventuza extra-puternica

 NUMER  
KATALOGOWY

SCBS8

110 kg

140 kg

8"

1200 mAh

1/10

**POMPKA AKUMULATOROWA**

Electric Battery Vacuum • Помпа для присоски • Pompa electrica de rezerva

 NUMER  
KATALOGOWY

SCBS8-PG

1200 mAh

1/10/100



**PRZYSSAWKA Z AKUMULATOREM I WYŚWIETLACZEM**

Vacuum suction cup • Вакуумная присоска для плитки и стекла с манометром • Vakuu Saugheber mit Manometer • Ventuza extra-puternica

NUMER KATALOGOWY	MAX kg	8"	5000 mAh	1/10
SCBA8	140 kg	8"	5000 mAh	1/10



**PRZYSSAWKA**

Vacuum suction cup • Вакуумная присоска для плитки и стекла с манометром • Vakuu Saugheber mit Manometer • Ventuza extra-puternica

NUMER KATALOGOWY	MAX kg	8"	1/10
SCVB8	120 kg	8"	1/10



**PRZYSSAWKA**

Vacuum suction cup • Вакуумная присоска для плитки и стекла • Vakuu Saugheber • Ventuza extra-puternica

NUMER KATALOGOWY	MAX kg	8"	1/10
SCVU8	110 kg	8"	1/10
SCVU8-PG	ttok/plunger		1/10



**PRZYSSAWKA**

Vacuum suction cup • Вакуумная присоска для плитки и стекла • Vakuu Saugheber • Ventuza extra-puternica

NUMER KATALOGOWY	MAX kg	6"	1/10
SCVM6	100 kg	6"	1/10
SCV-PG6	ttok/plunger		1/10



**PRZYSSAWKA PLASTIKOWA**

Vacuum suction cup • Вакуумная присоска для плитки и стекла • Vakuu Saugheber • Ventuza extra-puternica

NUMER KATALOGOWY	MAX kg	4"	1/6/36
SCSP4	35 kg	4"	1/6/36



**PRZYSSAWKA Z METALOWĄ PODSTAWĄ**

Vacuum suction cup • Вакуумная присоска для плитки и стекла • Vakuuum Saugheber • Ventuza extra-puternica

 NUMER  
KATALOGOWY

SCSB4

40 kg

4.8"

1/24

**PRZYSSAWKA Z METALOWĄ PODSTAWĄ - PODWÓJNA**

Vacuum suction cup • Вакуумная присоска для плитки и стекла • Vakuuum Saugheber • Ventuza extra-puternica

 NUMER  
KATALOGOWY

SCDB4

85 kg

5"

1/12

**PRZYSSAWKA Z METALOWĄ PODSTAWĄ - POTRÓJNA**

Vacuum suction cup • Вакуумная присоска для плитки и стекла • Vakuuum Saugheber • Ventuza extra-puternica

 NUMER  
KATALOGOWY

SCTB4

110 kg

5"

1/10

**ZESTAW RAJBEREK Z WYMIENNYM UCHWYTEM**

Switchable Notched Trowel Set • Переключаемый зубчатый шпатель • Schaltbares Kerbkellen-Set • Set profesional gletiere

 NUMER  
KATALOGOWY

Skrzynka transportowa

2x uchwyt

Ząb 6 mm

Ząb 8 mm

Ząb 10 mm

Ząb 12 mm

Ząb skośny 10 mm

Ząb Tiger

PTSJK9

1/5

**ZESTAW RAJBEREK Z WYMIENNYM UCHWYTEM**

Switchable Notched Trowel Set • Переключаемый зубчатый шпатель • Schaltbares Kerbkellen-Set • Set profesional gletiere

 NUMER  
KATALOGOWY

Skrzynka transportowa

Uchwyt

Ząb 6 mm

Ząb 8 mm

Ząb 10 mm

Ząb 12 mm

Ząb półokrągły 10x20 mm

Ząb Tiger

PTSJG8

1/5

**UCHWYT SOFT DO RAJBEREK**

Soft grip handle • Ручка для набора гребенок • Soft-Griff  
• Maner interschimbabil cu prindere moale pt. gletiere

NUMER KATALOGOWY			
PTSJHD	100 kg	6"	1/10



**WYMIENNE OSTRZE RAJBERKI - ZĄB KWADRATOWY**

Replacement trowel blade • Запасное лезвие для набора гребенок  
• Glättkelle mit Soft-Griff • Gletiera otel inoxidabil

NUMER KATALOGOWY				
PTSJ06	6 mm	115 mm	280 mm	1/10/50
PTSJ08	8 mm	115 mm	280 mm	1/10/50
PTSJ10	10 mm	115 mm	280 mm	1/10/50
PTSJ12	12 mm	115 mm	280 mm	1/10/50



**WYMIENNE OSTRZE RAJBERKI - ZĄB PÓŁOKRĄGŁY**

Replacement trowel blade • Запасное лезвие для набора гребенок  
• Glättkelle mit Soft-Griff • Gletiera otel inoxidabil

NUMER KATALOGOWY				
PTSJ20	20 mm	115 mm	280 mm	1/10/50



**RAJBERKA NIERDZEWNA**

Replacement trowel blade • Запасное лезвие для набора гребенок  
• Glättkelle mit Soft-Griff • Gletiera otel inoxidabil

NUMER KATALOGOWY			
PTSJTG	115 mm	280 mm	1/10/50



**RAJBERKA NIERDZEWNA**

Plastering trowel, stainless steel, soft-grip handle • Гладилка нерж. • Glättkelle mit Soft-Griff • Gletiera otel inoxidabil

NUMER KATALOGOWY			
PTSBPL	120 mm	280 mm	1/6/36



**RAJBERKA NIERDZEWNA ZĘBATA**

Square notched tiling trowel, soft-grip handle • Гладилка нерж. на алюмин. подст. • Glättetelle gezahnt mit Soft-Griff • Gletiera inox

NUMER KATALOGOWY				
PTSB03	3,2 mm	120 mm	280 mm	1/6/36
PTSB04	4 mm	120 mm	280 mm	1/6/36
PTSB06	6 mm	120 mm	280 mm	1/6/36
PTSB08	8 mm	120 mm	280 mm	1/6/36
PTSB10	10 mm	120 mm	280 mm	1/6/36
PTSB12	12 mm	120 mm	280 mm	1/6/36

**RAJBERKA NIERDZEWNA ZĄB PÓŁOKRĄGLY**

U notched Trowel • Гладилка нерж. полукруглый зуб,ручка • Glättetelle halbrund zahn • Gletiera zimtata dinti profil semirotond

NUMER KATALOGOWY				
PTSB20	9,5 mm	120 mm	280 mm	1/6/36

**RAJBERKA NIERDZEWNA ZĄB TIGER**

Tiger tooth tiling trowel • Гладилка нерж. "зуб тигра" • Glättetelle gezahnt mit Soft-Griff • Gletiera dintata INOX

NUMER KATALOGOWY				
PTSBTG		120 mm	280 mm	1/6/36

**WIADRO GLAZURNICZE**

Tiling set • Набор для облицовочных работ • Fliesenlegerset • Set pentru curatat gresie &amp; faianta

NUMER KATALOGOWY		
TWS19	19 L	1

**PACA Z GĄBKĄ PONACINANĄ HYDRO**

Trowel with scatching sponge • Терка пласт. с надрезанной резиновой губкой • Fliesenwaschbrett • Drisca burete hidro-absorbant profilată

NUMER KATALOGOWY			
CFHSS11	140 mm	280 mm	1/12/60



**PACA Z PODKŁADKĄ Z TWORZYWA EVA**

Grout float • Поплавок для раствора EVA с мягким захватом • EVA Grout Float mit weichem Griff • Drisca cauciuc

NUMER KATALOGOWY			
CFES11	140 mm	280 mm	1/10/40

**BIHUI**



**PACA Z GUMĄ TWARDĄ**

Epoxy Grout Float • Эпоксидная шпатлевка • Epoxy Mörtel Float • Drisca cu maner si baza de cauciuc

NUMER KATALOGOWY			
CFHRL	116 mm	248 mm	1/10/40

**BIHUI**



**PACA Z PODKŁADKĄ GUMOWĄ EVA**

Grout Float • Затирка для затирки • Fugenschwimmer • Drisca cu maner TPR si baza EVA

NUMER KATALOGOWY			
CFERS	100 mm	240 mm	1/6/48

**BIHUI**



**GĄBKA HYDRO**

Grout sponge Hydro • Губка для облицовочной плитки HYDRO • Hydroschwamm • Burete Hidro

NUMER KATALOGOWY				
CFHS165	60 mm	110 mm	165 mm	1/100

**BIHUI**



**GĄBKA CELULOZOWA**

Cellulose Sponge • Целлюлозная Губка • Celluloseschwamm • Burete din celuloza

NUMER KATALOGOWY				
CFCS180	50 mm	110 mm	180 mm	1/100

**BIHUI**



**KIELNIA DO FUG**

Gauging Trowel • Шпатель • Messkelle • Mistrie rotunda

 NUMER  
KATALOGOWY

BTCHG6

180 mm

1/6/36

**KIELNIA WYKOŃCZENIOWA**

Margin Trowel • Кельма • Randkelle • Mistrie dreapta

 NUMER  
KATALOGOWY

BTCHM5

125 mm

1/6/36

**KIELNIA TRAPEZOWA**

Bucket Trowel • Мастерок • Eimerkelle • Mistrie dreapta

 NUMER  
KATALOGOWY

BTCHB5

140 mm

1/6/36

BTCHB7

180 mm

1/6/36

**SZPACHELKA PODGIĘTA**

Bent pole scraper • Скребок с резьбой • Universalschaber • Spaclu pentru razuit cu varf indoit

 NUMER  
KATALOGOWY

TRSC4

100 mm

1/12/72

**SZPACHELKA DO WYBIERANIA MASY**

Bucket scoop • Шпатель малярный для ведра/таза, круглый • Eimerschaber • Mistrie rotunda

 NUMER  
KATALOGOWY

PTK165

165 mm

1/12/72

**PODNOŚNIK GLAZURNICZY**

Tile lifter • Устройство для поднятия и выравнивания плитки • Fliesen-und Plattenheber • Unealta manuala pentru pozitionare nivelare placi ceramic

NUMER KATALOGOWY			
TAS25	80 kg	1 - 20 cm	1/10



**SKROBAK DO FUG**

Sealant remover • Брусочка для швов • Fugenkratzer • Razuitoare placi ceramice

NUMER KATALOGOWY	
TGRS2	1/10/100



**OŁÓWEK AUTOMATYCZNY**

Automatic Pencil Marker • Автоматический карандашный маркер • Automatischer Bleistiftmarker • Creion automat

NUMER KATALOGOWY	
TCM7	1/12/144



**WKŁADY DO OŁÓWKA AUTOMATYCZNEGO**

Spare leads for automatic pencil • Запасные провода • Ersatzkabel für Automatischer Bleistiftmarker • Cabluri de rezervă pentru Creion automat

NUMER KATALOGOWY	
TCM7-SL	1/100/400



**ZESTAW OŁÓWKÓW**

Tile Marker(3pcs.) • Плитка Маркер(3 шт) • Fliesenmarkierung(3 st) • Creion tamplarie

NUMER KATALOGOWY	
TCM3	1/12/240



**MŁOTEK GLAZURNICZY**

White rubber head hammer • Молоток резиновый белый • Gummihammer weiß • Ciocan cauciuc, al

NUMER KATALOGOWY	
RMWS24	1/6/24



**WYCISKACZ**

 Caulking gun • Пистолет для герметиков • Kartuschenpistole  
 • Pistol silicon

 NUMER  
 KATALOGOWY

TCG310

310 ml

1/6/12

**WYKROJNIK**

 Profile contour gauge • Шаблон для плитки • Konturenlehre  
 • Sablon masurare profil

 NUMER  
 KATALOGOWY

TPG250

254 mm

1/12/36

**ZESTAW DO NAKŁADANIA SILIKONU**

 Silicone and Sealant Repair Kit • Ремонтный комплект для силикона  
 и герметика • Reparaturset für Silikon und Dichtmittel • Set de reparare  
 silicon și etanșant

 NUMER  
 KATALOGOWY

STARK3

1/12/96

**SZPACHELKI DO SILIKONU (4 szt.)**

 Silicone sealant spreader (4 pcs.) • Шпатель для силикона (4 шт.)  
 • Fugenglätter Set 4-teilig • Spatula pentru silicon (4 bucati)

 NUMER  
 KATALOGOWY

STAK4

1/10/200

**NAKOLANNIKI**

Knee pads • Наколенники • Knieschoner • Genunchiere de protectie

 NUMER  
 KATALOGOWY

TKPG

1/12

**SYSTEM POZIOMOWANIA PŁYTEK WIELOKROTNEGO UŻYTKU**

Reusable tile leveling system • Система за изравняване на плочки за многократно употреба • Wiederverwendbar Fliesen Nivelliersystem • Sistem reglabil, reutilizabil de nivelare a plăcilor

NUMER KATALOGOWY				
TSL50	50 szt.	1,5 mm	17 mm	1/12
TSL50-SN	śruby/nails	50 szt.	1,5 mm	17 mm

**BIHUI**



**KLIPSY DO POZIOMOWANIA PŁYTEK**

Tile leveling clips • Клипсы для выравнивания плиток • Zuglaschen • Distanriere pentru gresie si faianta

NUMER KATALOGOWY			
BLS1100	100 szt.	1 mm	1/10/40
BLS2100	100 szt.	1,5 mm	1/10/40
BLSN100	100 szt.	2 mm	1/10/40
BLS3100	100 szt.	3 mm	1/10/40

**BIHUI**



**KLINY DO POZIOMOWANIA PŁYTEK**

Leveling clips • Клинья для выравнивания плиток • Fliesen Nivelliersystem-Keile • Pene nivelare placi ceramice

NUMER KATALOGOWY		
BLSE100	100 szt.	1/5/20

**BIHUI**



**PODKŁADKI POD SYSTEM POZIOMOWANIA**

Universal Transparent Plastic washer with hollow • Универсальная прозрачная подкладка с полостью • Protecție placa ceramica pentru distantieri nivelare cu infiletare

NUMER KATALOGOWY		
SLW100	100 szt.	1/8/32

**BIHUI**

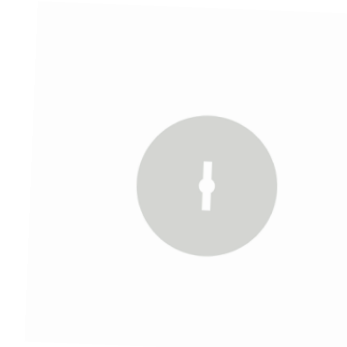

**SZCZYPCE DO SYSTEMU POZIOMOWANIA PŁYTEK**

Tile leveling plier • Щипцы для системы выравнивания плиток • Zange für Bodenverlegung • Cleste pentru distantiere autonivelante

NUMER KATALOGOWY	
BLSFP	1/6/24

**BIHUI**



**ROLKA DO USUWANIA KLIPSÓW**

Levelling Removal Dozer • Выравнивание Снятие бульдозера • Planierraupen-Entfernungsmesser • Dozer de îndepărtare de nivel

 NUMER  
KATALOGOWY

BLSRR

1/10

**KLINY TYPU C**

 Tile spacers C-type • Клинья для выравнивания плитки тип „C”  
• Fliesenkeile C-Form • Pene distantiere pentru gresie tip C

 NUMER  
KATALOGOWY

TSR50

50 szt.

1 - 13 mm

1/10/100

**KRZYŻYKI GLAZURNICZE MULTI (50 szt.)**

 Multi size spacers • Многоразмерная прокладка для плитки  
• Multi-Size Fliesenabstandshalter • Distanțator de plăci cu dimensiuni multiple

 NUMER  
KATALOGOWY

TSM50

50 szt.

1 - 4 mm

1/10/100

**TARCZA TURBO FAN**

Diamond cutting disc • Диск алмазный • Diamanttrennscheibe • Disc diamantat

 NUMER  
KATALOGOWY

DCWF5

125 mm

1/5/20

**TARCZA DIAMENTOWA TURBO**

Diamond cutting disc • Диск алмазный • Diamanttrennscheibe • Disc diamantat

 NUMER  
KATALOGOWY

DCWT5

125 mm

1/5/20

**TARCZA DIAMENTOWA DWURZĘDOWA**

Diamond cutting disc • Диск алмазный • Diamanttrennscheibe • Disc diamantat

 NUMER  
KATALOGOWY

DCWD5

125 mm

1/5/20

**TARCZA DO CIĘCIA I SZLIFOWANIA KRAWĘDZI**

Edge Cutting and Grinding Blade • Лезвие для резки и шлифовки кромок  
• Kantenschneid- und Schleifblatt • Lamă de tăiat și șlefuit de 5 inchi

NUMER KATALOGOWY		
DPE125	125 mm	1/10/80

**BIHUI**



**TARCZA DIAMENTOWA B-MASTER**

Diamond cutting disc • Диск алмазный • Diamanttrennscheibe • Disc diamantat

NUMER KATALOGOWY		
DCDA115	115 mm	1/20/80

**BIHUI**



**TARCZA DIAMENTOWA B-SPEEDY**

Diamond cutting disc • Диск алмазный • Diamanttrennscheibe • Disc diamantat

NUMER KATALOGOWY		
DCDM115	115 mm	1/20/80

**BIHUI**



**TARCZA DIAMENTOWA DO PODCINANIA**

Diamond cutting disc • Диск алмазный • Diamanttrennscheibe • Disc diamantat

NUMER KATALOGOWY		
DCW50	50 mm	1/10/80

**BIHUI**



**TARCZA DIAMENTOWA DO CIĘCIA I SZLIFOWANIA DWUSTRONNA**

Diamond Cutting and Grinding Wheel • Алмазный отрезной и шлифовальный круг с гальваническим покрытием • Galvanisierte Diamantschneid- und Schleifscheibe • Tăiere și șlefuit cu diamant electroplatat

NUMER KATALOGOWY		
DCWME5	125 mm	1/5/20

**BIHUI**



**TARCZA DIAMENTOWA LISTKOWA**

Diamond Grinding Flap Wheel • Универсальный алмазный шлифовальный круг • Universal-Diamant-Schleifscheibe • Roată cu clapă de măcinat cu diamant

NUMER KATALOGOWY		
DPF060	115 mm	1/10/40
DPF200	115 mm	1/10/40

**TARCZA DIAMENTOWA SUPER THIN**

Diamond cutting disc • Диск алмазный • Diamanttrennscheibe • Disc diamantat

NUMER KATALOGOWY		
DCBN115	115 mm	1/10/80
DCBN5	125 mm	1/10/80

**ZESTAW OTWORNIC Z WALIZKĄ**

Turbo Tile Dry Drill Set • Набор сверл для сухой плитки • Turbo Tile Trockenbohrset • Set de ferăstrău cu gaură cu diamant

NUMER KATALOGOWY		
DBDMK4	25, 40, 60, 70 mm	1/10
DBDMS4	22, 35, 38, 50 mm	1/10

**ZESTAW OTWORNIC Z WALIZKĄ**

Turbo Tile Dry Drill Set • Набор сверл для сухой плитки • Turbo Tile Trockenbohrset • Set de ferăstrău cu gaură cu diamant

NUMER KATALOGOWY		
DBDMS5	20, 35, 55, 60, 75 mm	1/10

**ZESTAW OTWORNIC Z WALIZKĄ**

Turbo Tile Dry Drill Set • Набор сверл для сухой плитки • Turbo Tile Trockenbohrset • Set de ferăstrău cu gaură cu diamant

NUMER KATALOGOWY		
DBDMK6	6, 8, 20, 35, 50, 70 mm	1/10



**ZESTAW OTWORNIC Z WALIZKĄ**

Turbo Tile Dry Drill Set • Набор сверл для сухой плитки • Turbo Tile Trockenbohrset • Set de ferăstrău cu gaură cu diamant

NUMER KATALOGOWY		
DBDMS6	25, 35, 40, 45, 50, 68 mm	1/10

**BIHUI**



**ZESTAW OTWORNIC Z WALIZKĄ**

Turbo Tile Dry Drill Set • Набор сверл для сухой плитки • Turbo Tile Trockenbohrset • Set de ferăstrău cu gaură cu diamant

NUMER KATALOGOWY		
DBDMS7	20, 25, 35, 40, 45, 68 mm + frez 20 - 48 mm	1/10

**BIHUI**



**ZESTAW OTWORNIC Z WALIZKĄ**

Turbo Tile Dry Drill Set • Набор сверл для сухой плитки • Turbo Tile Trockenbohrset • Set de ferăstrău cu gaură cu diamant

NUMER KATALOGOWY		
DBDMK5	6, 8, 10, 12 mm + adapter	1/10

**BIHUI**



**TARCZA DO OBRABIANIA KRAWĘDZI PŁYTEK DO 10 mm WKŁĘŚŁA**

Bullnose grinding wheel • Шлифовальный круг • Bullnose-Schleifscheibe • Roată de șlefuit Bullnose

NUMER KATALOGOWY		
DGW310	75 mm	1/10/80

**BIHUI**



**FREZ DIAMENTOWY**

Diamond Mill • Алмазная мельница • Diamantmühle • Moara de diamant

NUMER KATALOGOWY		
DMB10	10 mm	1/10/40
DMB20	20 mm	1/10/40

**BIHUI**



**FREZ DIAMENTOWY STOŻKOWY**

Diamond Mill • Алмазная мельница • Diamantmühle • Moara de diamant

NUMER KATALOGOWY		
DMC238	2 - 38 mm	1/10/40

**BIHUI**



**FREZ DIAMENTOWY STOŻKOWY ŚCIĘTY**

Diamond Mill • Алмазная мельница • Diamantmühle • Moara de diamant

 NUMER  
KATALOGOWY

DMF2048

20 - 48 mm

1/10/40

**OTWORNICA DIAMENTOWA**

 Brazed Diamond Dry Drill Bit • Сверло-коронка алмазная для керамогранита  
• Diamant-Lochsäge • Coroana diamantata

 NUMER  
KATALOGOWY

DBDF06

6 mm

1/10/100

DBDF08

8 mm

1/10/100

DBDF10

10 mm

1/10/100

DBDF12

12 mm

1/10/100

DBDF14

14 mm

1/10/100

DBDF20

20 mm

1/10/50

DBDF22

22 mm

1/10/50

DBDF30

30 mm

1/10/50

DBDF35

35 mm

1/10/50

DBDF40

40 mm

1/5/20

DBDF45

45 mm

1/5/20

DBDF50

50 mm

1/5/20

DBDF60

60 mm

1/5/20

DBDF65

65 mm

1/5/20

DBDF68

68 mm

1/5/20

DBDF70

70 mm

1/5/20

DBDF75

75 mm

1/5/20

DBDF82

82 mm

1/5/20

DBDF100

100 mm

1/10

DBDF115

115 mm

1/10

**OTWORNICA DIAMENTOWA**

 Brazed Diamond Dry Drill Bit • Сверло-коронка алмазная для керамогранита  
• Diamant-Lochsäge • Coroana diamantata

 NUMER  
KATALOGOWY

DBDQ06

6 mm

1/10/100

DBDQ08

8 mm

1/10/100

DBDQ10

10 mm

1/10/100

DBDQ12

12 mm

1/10/100

**ADAPTER M14-HEX**

 Drill Chuck Adaptor • Адаптер сверлильного патрона • Bohrfutteradapter  
• Adăugați adaptorul Chuck

 NUMER  
KATALOGOWY

DBAMH

1/10/100

**WOSK CHŁODZĄCY**

Wax for Diamond Dry Drills • Воск охлаждающий для коронок  
• Ceara pt. racire carote

NUMER KATALOGOWY		
DBCW20	20 ml	1/100



**GĄBKA DO SZLIFOWANIA DIAMENTOWA**

Diamond sanding sponge • Губка для шлифования  
• Diamant-Schleifschwamm • Burete abraziv diamant

NUMER KATALOGOWY		
DHP060	60	1/10/40
DHP120	120	1/10/40
DHP200	200	1/10/40
DHP400	400	1/10/40



**PODKŁADKA NA RZEP DO KRAŻKÓW**

Polishing Pad Holder • Держатель для полировки • Polierkissenhalter • Suport de polizare

NUMER KATALOGOWY		
DPPH4	100 mm	1/10/40



**KRAŻEK DO POLEROWANIA**

Diamond Polishing Pads • Угломер столярный • Diamantpolierkissen • Seturi de lustruit diamant

NUMER KATALOGOWY			
DPP405	100	50	1/25/100
DPP410	100	100	1/25/100
DPP420	100	200	1/25/100

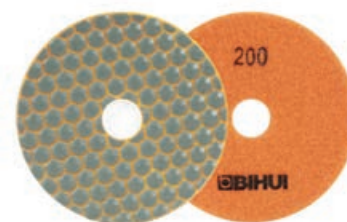

**TARCZ DO ZDZIERANIA KLEJU**

Coating & Glue Grinding Cup Wheel • Шлифовальный круг для нанесения покрытий и клея с вакуумной пайкой • Vakuumgelötete Beschichtungs- und Leimschleifscheibe • Roată de cupă de acoperire brazată cu vid și lipire

NUMER KATALOGOWY		
DCWG5	125 mm	1/10/40



**RĘKAW DO FUG - PLASTIKOWA KOŃCÓWKA**

Grout Bag • Рукав для затирки швов • Mörtelbeutel

NUMER KATALOGOWY	
GBP23	1/100



**RĘKAW DO FUG - STALOWA KOŃCÓWKA**

Grout Bag • Рукав для затирки швов • Mörtelbeutel • Dispozitiv pentru chituire

 NUMER  
KATALOGOWY

GBS21

1/100

**ADAPTER DO ODCIĄGU PYŁU Z WIADRA**

 Bucket Dust Collector • Ковшовый пылеуловитель • Eimerstaubsammler  
• Colector de praf de găleată

 NUMER  
KATALOGOWY

TDBM

1/20

**ADAPTER DO ODSYSANIA PYŁU PODCZAS WIERCENIA**

 Carpenter angle ruler • Экстрактор буровой пыли • Bohrstaubsauger  
• Extractor de praf de foraj

 NUMER  
KATALOGOWY

TDBS

1/20

**ADAPTER DO ODSYSANIA PYŁU PODCZAS CIĘCIA**

 Cutting Dust Extractor • Пылеуловитель для резки • Schreinerwinkel • Sistem  
extractie praf la taieri

 NUMER  
KATALOGOWY

TDDB

1/10

**ADAPTER DO ODSYSANIA PYŁU PODCZAS SZLIFOWANIA**

 Grinding Dust Extractor • Измельчитель пыли • Schleifstaubsaugung  
• Extractor de praf de măcinat

 NUMER  
KATALOGOWY

DCWDE5

1/5/20

**SZABLON DO KSZTAŁTÓW NA PRZYSSAWCE**

Drill Guide Master • Мастер по бурению • Bohrerführungsmeister • Ghidul de foraj maestru



NUMER  
KATALOGOWY



DBGM

1/20

**PROWADNICA DO WIERCENIA**

Universal Drill Guide • Универсальный гид • Universelle Anleitung • Ghid universal



NUMER  
KATALOGOWY



DBGU

4, 5, 6, 8, 10, 12, 14 mm

1/10/60



# DRABINY

ЛЕСТНИЦЫ • LADDERS

• LEITERN • SCĂRI



# PODEST ROBOCZY

**Faraone**



to kompaktowy podest, który przeznaczony jest do profesjonalnych prac monterskich, konserwacyjnych i serwisowych. Sprawdzi się także w pracach przydomowych. Dzięki kompaktowym rozmiarom po złożeniu, podest nie zajmuje dużo miejsca i łatwo go przetransportować. Model 3-stopniowy został dodatkowo wyposażony w poręcz oraz stabilizator poprzeczny zwiększając tym samym bezpieczeństwo. Dodatkowo zamontowane kółka ułatwiają i usprawniają jego przemieszczanie.



O SZCZEGÓŁY I DOSTĘPNOŚĆ  
ZAPYTAJ HANDLOWCĘ W TWOIM REGIONIE



## PODEST ROBOCZY SGS

NUMER KATALOGOWY				A	B	C	D
SGS2	12 kg	150 kg	2	49 cm	36 cm	120 cm	155 cm
SGS3	17 kg	150 kg	3	77 cm	36 cm	120 cm	183 cm

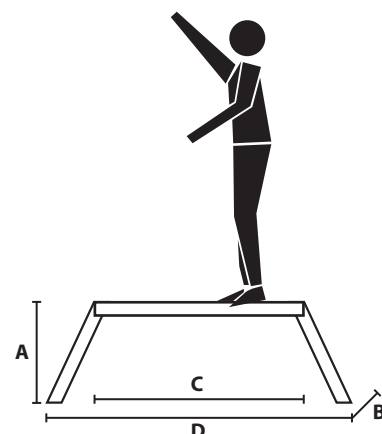



# DRABINA WOLNOSTOJĄCA

**FARADOME**

to drabina przeznaczona do intensywnych i profesjonalnych prac montażowych czy magazynowych. Dzięki szerokim na 8 cm, ryflowanym stopniom drabina jest bezpieczna i ergonomiczna. Mocna i trwała konstrukcja, specjalny lotniczy system montażu stopni zapewnia 100% bezpieczeństwo podczas użytkowania drabiny. Dla zwiększenia wygody i ergonomii użytkowania drabina została wyposażona w praktyczną torbę na narzędzia. Stabilność drabiny została zwiększona dzięki zastosowaniu wzmocnienia w postaci zamontowanego krzyża stabilizującego w tylnej części drabiny oraz wzmocnień w narożnikach pomiędzy pierwszym stopniem, a podłużnicą.





konstrukcja, specjalny lotniczy system montażu stopni zapewnia 100% bezpieczeństwo podczas użytkowania drabiny. Dla zwiększenia wygody i ergonomii użytkowania drabina została wyposażona w praktyczną torbę na narzędzia. Stabilność drabiny została zwiększona dzięki zastosowaniu wzmocnienia w postaci zamontowanego krzyża stabilizującego w tylnej części drabiny oraz wzmocnień w narożnikach pomiędzy pierwszym stopniem, a podłużnicą.



 O SZCZEGÓŁY I DOSTĘPNOŚĆ ZAPYTAJ HANDLOWCĘ W TWOIM REGIONIE



## DRABINA WOLNOSTOJĄCA

NUMER KATALOGOWY				A	B	C	
LADY3	7 kg	150 kg	3	264 cm	64 cm	82 cm	1
LADY4	7,3 kg	150 kg	4	287 cm	87 cm	86 cm	1
LADY5	8,5 kg	150 kg	5	310 cm	110 cm	102 cm	1
LADY6	9,3 kg	150 kg	6	333 cm	133 cm	118 cm	1
LADY7	11 kg	150 kg	7	356 cm	156 cm	135 cm	1

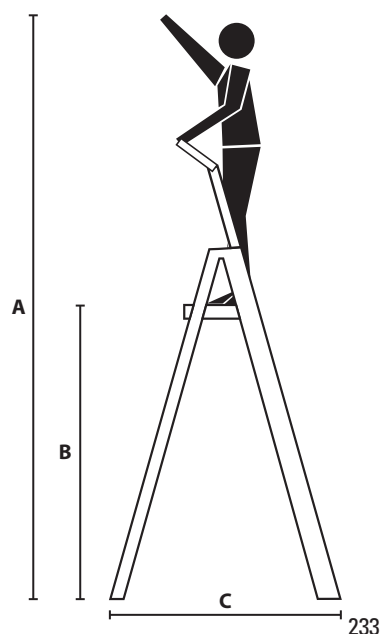

# DRABINA TELESKOPOWA

**TARADOME**

to wielofunkcyjna, aluminiowa drabina teleskopowa do różnych zastosowań, jako drabina wolnostojąca, przystawna i z możliwością ustawiania na nierównym podłożu, również na schodach i podestach.

Przemysłana konstrukcja daje możliwość złożenia jej przez co zajmuje niewiele miejsca i jest łatwa do przemieszczania. Dzięki wygiętym dolnym podłużnicom, zakończonym antypoślizgowymi stopkami, drabina gwarantuje stabilność i komfort użytkowania.

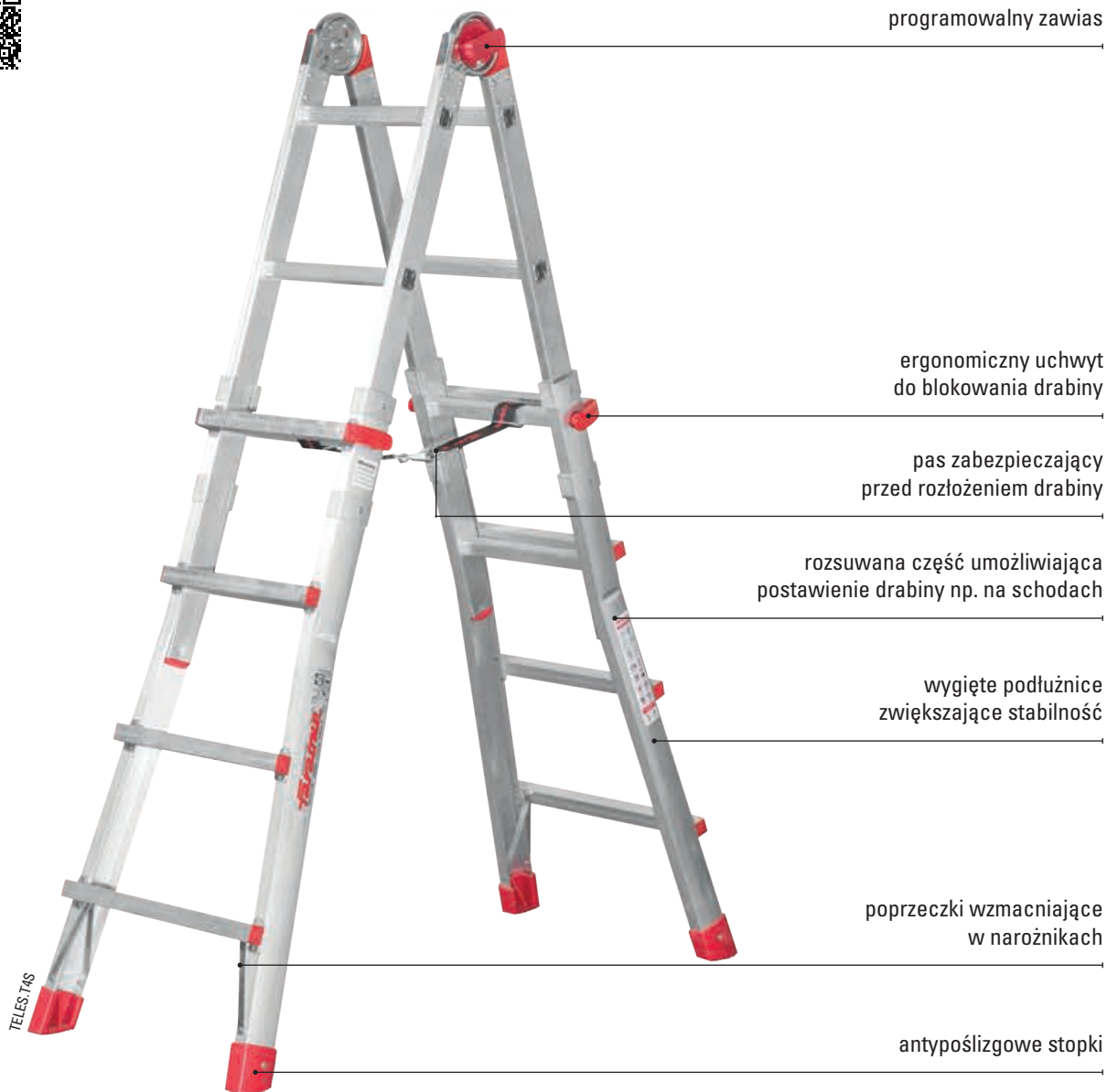

programowalny zawias

ergonomiczny uchwyt do blokowania drabiny

pas zabezpieczający przed rozłożeniem drabiny

rozsuwana część umożliwiająca postawienie drabiny np. na schodach

wygięte podłużnice zwiększające stabilność

poprzeczki wzmacniające w narożnikach

antypoślizgowe stopki



O SZCZEGÓŁY I DOSTĘPNOŚĆ  
ZAPYTAJ HANDLOWCĘ W TWOIM REGIONIE

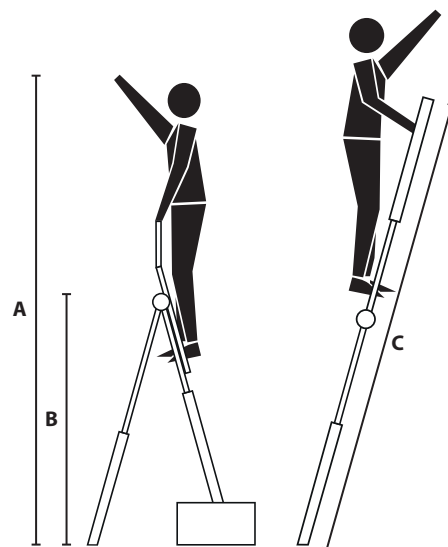

## DRABINA TELESKOPOWA

NUMER KATALOGOWY		Max		A	B	C	
TELES.T4S	13,5 kg	150 kg	8+8	358 cm	212 cm	420 cm	1
TELES.T5S	15,5 kg	150 kg	10+10	388 cm	240 cm	470 cm	1
BRTALES				poręcz z podestem opcjonalnie do kupienia			

# DRABINA WIELOFUNKCYJNA

**TARAONE**

to wielofunkcyjna i maksymalnie bezpieczna drabina przeznaczona zarówno do prac remontowo-budowlanych jak i wielu innych. Doskonale sprawdzi się w przypadku użytkowników profesjonalnych podczas codziennej eksploatacji. Wielofunkcyjność drabin AK polega na szerokich możliwościach ich zastosowania: jako drabiny przystawne, rozsuwane trzyelementowe, wolnostojące. Można je również rozdzielić na dwie niezależne drabiny: jedna dwuelementowa i druga jednoelementowa.

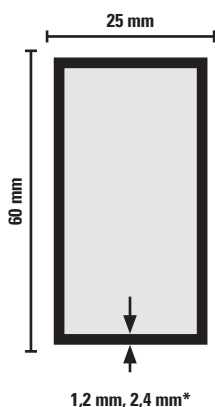
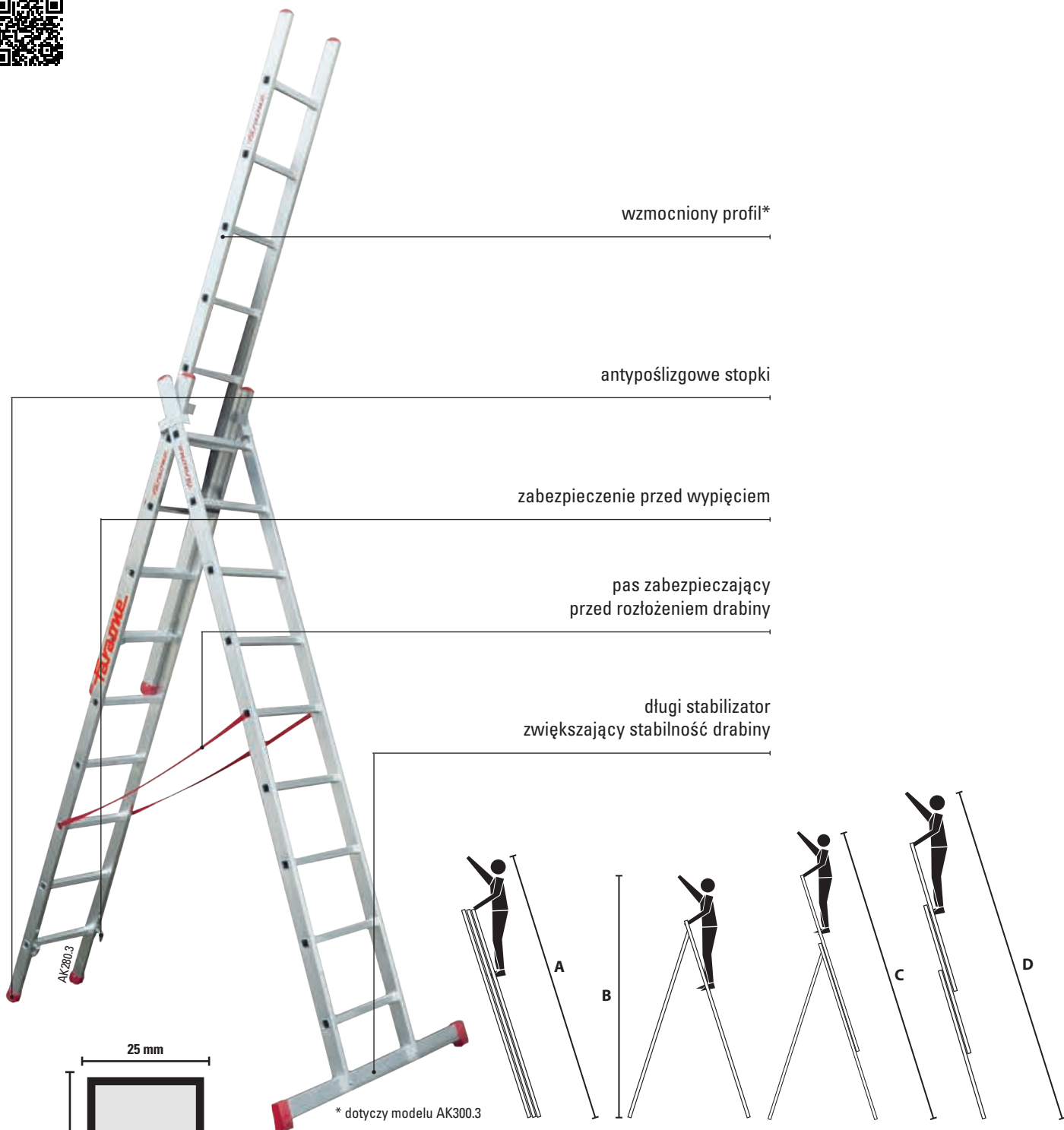

DRABINA WIELOFUNKCYJNA									
NUMER KATALOGOWY				A	B	C	D		
AK225.3	13 kg	150 kg	3x7	345 cm	330 cm	400 cm	530 cm	1	
AK250.3	15 kg	150 kg	3x8	370 cm	360 cm	500 cm	619 cm	1	
AK280.3	18 kg	150 kg	3x9	400 cm	390 cm	520 cm	675 cm	1	
AK300.3	21 kg	150 kg	3x10	420 cm	410 cm	550 cm	718 cm	1	

# PODEST ROBOCZY

**FARAONE**

to bezpieczny i funkcjonalny podest, służący do wykonywania na przykład prac magazynowych, serwisowych, budowlanych, elektrycznych i konserwacyjnych. Posiada podest o regulowanej wysokości. Kąt wchodzenia wynosi 70 stopni. Posiada podnoszoną barierkę ochronną, zamontowaną na wysokości 110 cm. Platforma robocza posiada burty, dzięki którym nie ma możliwości osunięcia się w dół nogi użytkownika stojącego na niej. Podest jest łatwy w obsłudze. Jest składany, więc nie zajmuje dużo miejsca, a zamontowane koła usprawniają i ułatwiają jego transport.

to bezpieczny i funkcjonalny podest, służący do wykonywania na przykład prac magazynowych, serwisowych, budowlanych, elektrycznych i konserwacyjnych. Posiada podest o regulowanej wysokości. Kąt wchodzenia wynosi 70 stopni. Posiada podnoszoną barierkę ochronną, zamontowaną na wysokości 110 cm. Platforma robocza posiada burty, dzięki którym nie ma możliwości osunięcia się w dół nogi użytkownika stojącego na niej. Podest jest łatwy w obsłudze. Jest składany, więc nie zajmuje dużo miejsca, a zamontowane koła usprawniają i ułatwiają jego transport.



praktyczna kieszka na narzędzia



15 cm burta zapobiegająca przypadkowemu zsunięciu się nogi

ergonomiczny uchwyt do blokowania drabiny

rozsuwana część umożliwiająca postawienie drabiny np. na schodach

wygięte podłużnice zwiększające stabilność

kółka ułatwiające przemieszczanie drabiny

poprzeczki wzmacniające w narożnikach

antyślizgowe stopki

O SZCZEGÓŁY I DOSTĘPNOŚĆ ZAPYTAJ HANDLOWCĘ W TWOIM REGIONIE

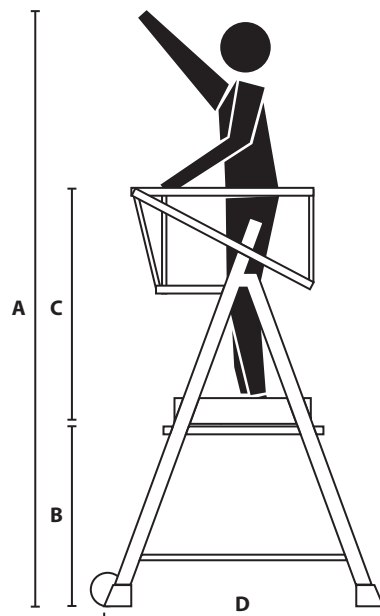

PODEST ROBOCZY								
NUMER KATALOGOWY				A	B	C	D	
PLS3	26 kg	150 kg	3	310 cm	80/130 cm	110 cm	132/175 cm	1
PLS5	32 kg	150 kg	5	418 cm	130/238 cm	110 cm	175/234 cm	1

# PLATFORMA DLA TYNKARZY

**FARADOME**

przeznaczona jest do robót tynkarskich, malarskich, wykonana z aluminium. Umożliwia przemieszczanie się wzdłuż ściany podczas pracy. Najwyższy stopień jest wykonany z kraty ortofoalowej (GRP), dzięki czemu nie zbierają się

na jego powierzchni zanieczyszczenia. Sama kratka jest lżejsza od stalowej i odporna na korozję. Stopień posiada ranty, które ułatwiają użytkowanie. Produkt posiada antypoślizgowe stopy i haki pozwalające na zawieszenie np. wiadra.

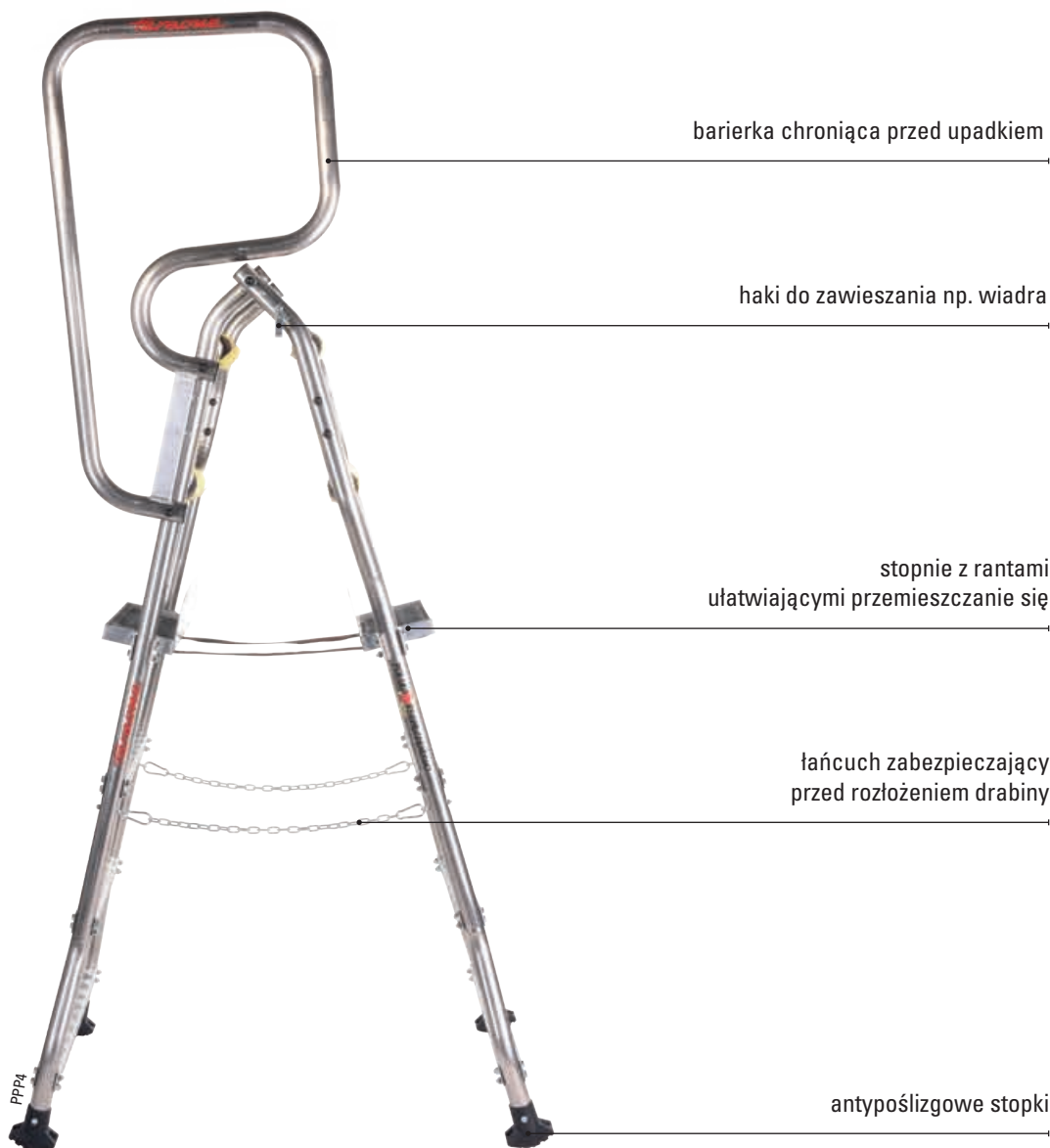

O SZCZEGÓŁY I DOSTĘPNOŚĆ  
ZAPYTAJ HANDLOWCĘ W TWOIM REGIONIE



## PLATFORMA DLA TYNKARZY

NUMER KATALOGOWY				A	B	C	D	E	
PPP4	16 kg	150 kg	4	298 cm	98 cm	65 cm	210 cm	67 cm	1
PPP5	18 kg	150 kg	5	325 cm	125 cm	65 cm	240 cm	67 cm	1
BR.PPP	poręcz standard dla modelu PP5/opcjonalnie do kupienia dla modelu PP4								

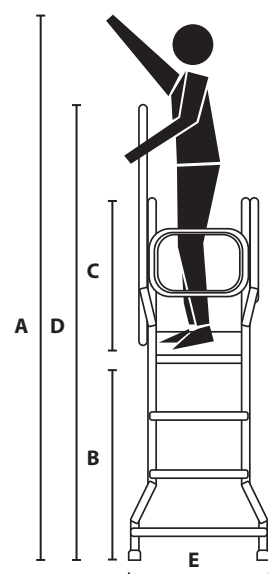

# MINIRUSZTOWANIE

**FARADOME**

idealnie sprawdzi się podczas wykonywania elewacji lub izolacji termicznej budynku. Stanowi niezbędny element każdego gospodarstwa domowego, jak również obowiązkowe wyposażenie na budowach. Jest ono stosunkowo lekkie i niezwykle proste w montażu. Z łatwością przetransportujesz je na miejsce budowy bez nadmiernej utraty czasu na jego złożenie. Dzięki zastosowaniu aluminium, rusztowanie chronione jest przed korozją w wyniku działania czynników atmosferycznych. Zamontowane kółka ułatwiają przesuwanie rusztowania.

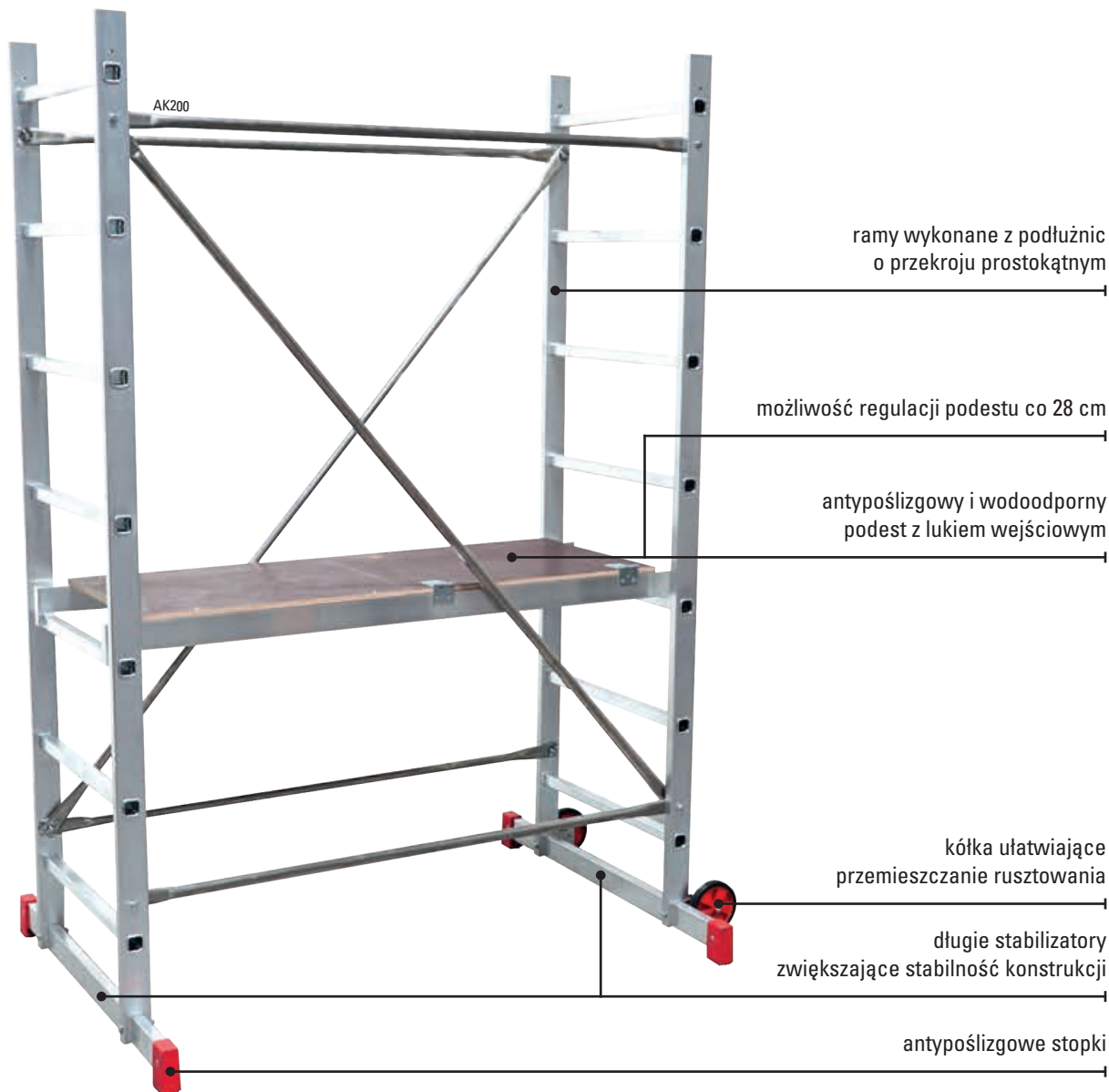

O SZCZEGÓŁY I DOSTĘPNOŚĆ  
ZAPYTAJ HANDLOWCĘ W TWOIM REGIONIE

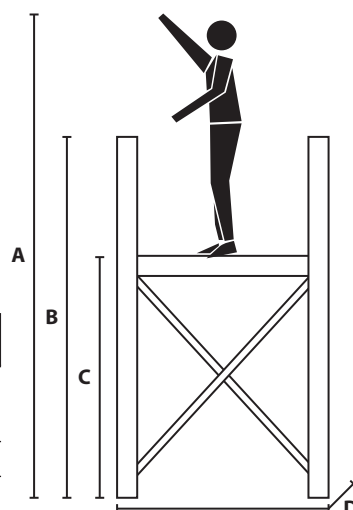

## MINIRUSZTOWANIE

NUMER KATALOGOWY				A	B	C	D	E	
AK200	16 kg	100 kg	7	300 cm	200 cm	100 cm	60 cm	140 cm	1
AK400	48 kg	100 kg	14	500 cm	400 cm	300 cm	60 cm	140 cm	1



## DRABINA STALOWA

Single-sided steel platform step ladders • Односторонняя бытовая стальная стремянка • Einseitige Klappleiter • Scară unilaterală



### Maksymalne obciążenie:

nośność do 125 kg

### Zgodność z europejską normą:

EN 131

- Wyjątkowo odporna na uderzenia czy odpryski
- Duży bezpieczny podest roboczy o wymiarach 25 cm x 26 cm
- Bezpieczne stopki z tworzywa sztucznego oraz dodatkowe zabezpieczenia stopni
- Szerokie, antypoślizgowe i karbowane stopnie

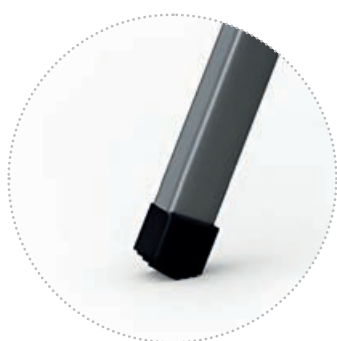

Antypoślizgowe stopki

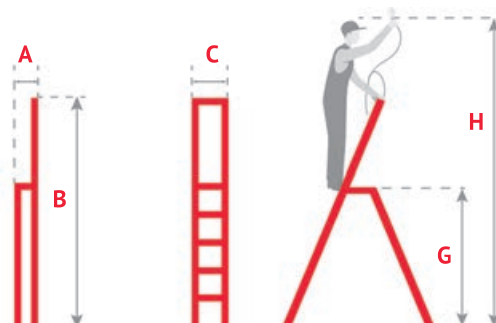

Numer katalogowy	Ilość stopni:	Masa:	A	B	C	G	H
120 130	1x4	4,9 kg	0,08 m	1,49 m	0,43 m	0,75 m	2,75 m
120 140	1x4 CZARNA	4,9 kg	0,08 m	1,49 m	0,43 m	0,75 m	2,75 m
120 131	1x5	6,1 kg	0,08 m	1,73 m	0,46 m	0,97 m	3 m



## DRABINA ALUMINIOWA Z PÓŁKĄ

Single-sided aluminium platform step ladders • Односторонняя бытовая алюминиевая стремянка • Einseitige Klappleiter • Scară unilaterală

**motive**   
Jakość ma znaczenie

### Maksymalne obciążenie:

nośność do 125 kg

### Zgodność z europejską normą:

EN 131

- Lekka i wygodna w przechowywaniu i transporcie
- Duży bezpieczny podest roboczy o wymiarach 25 cm x 26 cm
- Bezpieczne stopki z tworzywa sztucznego oraz dodatkowe zabezpieczenia stopki
- Szerokie, antypoślizgowe i karbowane stopnie



Półka na narzędzia wykonana z tworzywa sztucznego

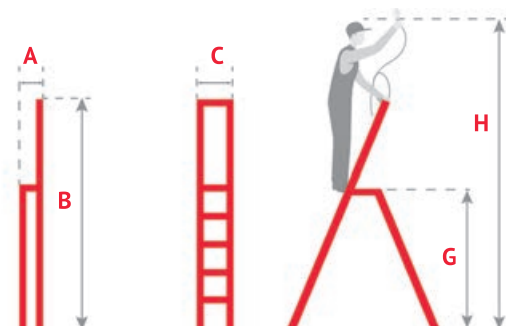

Numer katalogowy	Ilość stopni:	Masa:	A	B	C	G	H
120 093	1x4	3 kg	0,155 m	1,45 m	0,43 m	0,75 m	2,75 m
120 094	1x5	4,3 kg	0,155 m	1,68 m	0,45 m	0,97 m	2,97 m





## DRABINA ALUMINIOWA - JEDNOSTRONNA

Single-sided aluminium platform step ladders • Односторонняя бытовая алюминиевая стремянка • Einseitige Klappleiter • Scară unilaterală



### Maksymalne obciążenie:

nośność do 150 kg

### Zgodność z europejską normą:

EN 131

- Lekka i wygodna w przechowywaniu oraz transporcie
- Duży bezpieczny podest roboczy o wymiarach 25 cm x 25 cm
- Bezpieczne stopki z tworzywa sztucznego oraz dodatkowe zabezpieczenia stopni
- Szerokie, antypoślizgowe i karbowane stopnie

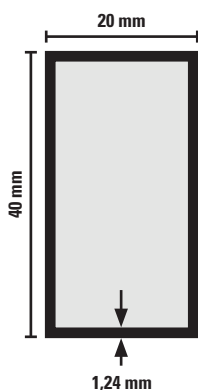

Opcjonalna półka na narzędzia do dokupienia



Tabela przedstawia parametry poszczególnych drabin z tej kategorii:

Numer katalogowy	Ilość stopni:	Masa:	A	B	C	G	H
120 043	1x3	3 kg	0,12 m	1,26 m	0,4 m	0,56 m	2,56 m
120 044	1x4	3,2 kg	0,12 m	1,5 m	0,43 m	0,78 m	2,78 m
120 045	1x5	3,6 kg	0,12 m	1,73 m	0,45 m	1 m	3 m
120 046	1x6	5,2 kg	0,12 m	1,97 m	0,48 m	1,22 m	3,22 m
120 047	1x7	6,9 kg	0,12 m	2,2m	0,5 m	1,45 m	3,45 m
120 048	1x8	7,4 kg	0,12 m	2,37 m	0,52 m	1,62 m	3,62 m

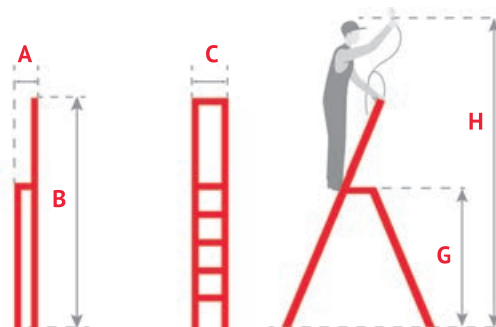

## DRABINA ALUMINIOWA - JEDNOSTRONNA

Single-sided aluminium platform step ladders • Односторонняя бытовая алюминиевая стремянка • Einseitige Klappleiter • Scară unilaterală

### DOMO

#### Maksymalne obciążenie:

nośność do 125 kg

- ✓ Lekka i wygodna w przechowywaniu oraz transporcie
- ✓ Duży bezpieczny podest roboczy o wymiarach 25 cm x 25 cm
- ✓ Bezpieczne stopki z tworzywa sztucznego oraz dodatkowe zabezpieczenia stopni
- ✓ Szerokie, antypoślizgowe i karbowane stopnie

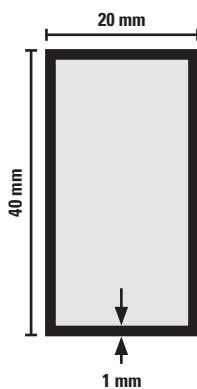

Opcjonalna półka na narzędzia do dokupienia



Tabela przedstawia parametry poszczególnych drabin z tej kategorii:

Numer katalogowy	Ilość stopni:	Masa:	A	B	C	G	H
120 001	1x3	2,5 kg	0,12 m	1,26 m	0,4 m	0,56 m	2,56 m
120 002	1x4	2,9 kg	0,12 m	1,5 m	0,43 m	0,78 m	2,78 m
120 003	1x5	3,3 kg	0,12 m	1,73 m	0,45 m	1 m	3 m
120 004	1x6	4,6 kg	0,12 m	1,97 m	0,48 m	1,22 m	3,22 m
120 005	1x7	5,1 kg	0,12 m	2,2m	0,5 m	1,45 m	3,45 m
120 006	1x8	5,8 kg	0,12 m	2,37 m	0,52 m	1,62 m	3,62 m



## DRABINA ALUMINIOWA - DWUSTRONNA

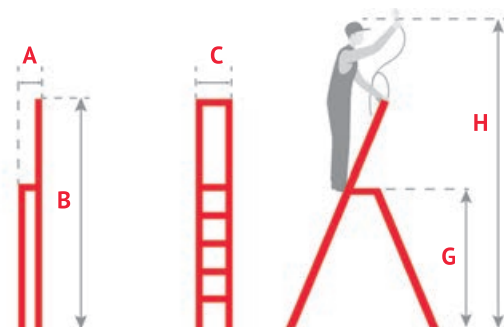

Double-sided aluminium step ladders • Двухсторонняя бытовая алюминиевая стремянка • Doppelseitige Klappleiter • Scară cu două fețe





### Maksymalne obciążenie:

 do 150 kg

### Zgodność z europejską normą:

-  EN 14183 (modele 2x2)
-  EN 131 (modele od 2x3 do 2x8)

-  Mocne podłużnice ze specjalnego stopu aluminium zakończone plastikowymi stopkami antypoślizgowymi
-  Szerokie karbowane stopnie przynitowane do podłużnic oraz zabezpieczone osłonkami z tworzywa sztucznego
-  Specjalne taśmy zabezpieczające drabinkę przed nadmiernym rozsunięciem

Wysokiej jakości drabinki dwustronne to produkt przeznaczony do pracy codziennej w pracy, w firmie oraz gospodarstwie domowym. Cechuje go wysoka jakość oraz obciążenie do 150 kg.



Tabela przedstawia parametry poszczególnych drabin z tej kategorii:



Numer katalogowy	Ilość stopni:	Masa:	A	B	C	G	H
120 014	2x2	1,85 kg	0,2 m	0,43 m	0,41 m	0,38 m	2,38 m
120 015	2x3	2,6 kg	0,2 m	0,67 m	0,43 m	0,61 m	2,61 m
120 016	2x4	3 kg	0,2 m	0,89 m	0,45 m	0,81 m	2,81 m
120 052	2x5	3,4 kg	0,2 m	1,14 m	0,47 m	1,03 m	3,03 m
120 053	2x6	4,1 kg	0,2 m	1,35 m	0,5 m	1,24 m	3,24 m
120 054	2x7	7,1 kg	0,2 m	1,57 m	0,52 m	1,46 m	3,46 m
120 055	2x8	8,3 kg	0,2 m	1,82 m	0,53 m	1,7 m	3,7 m

## DRABINA ALUMINIOWA - DWUSTRONNA

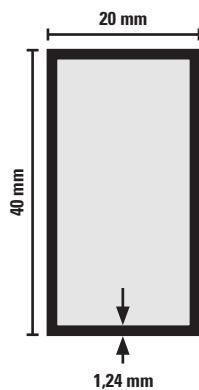
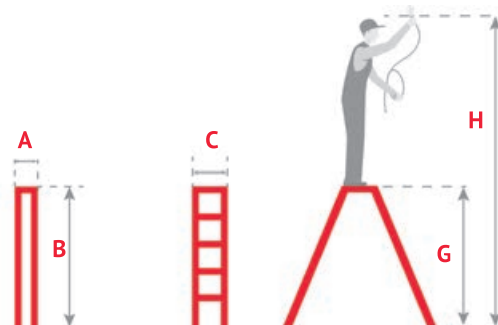
Double-sided aluminium step ladders • Двухсторонняя бытовая алюминиевая стремянка • Doppelseitige Klappleiter • Scară cu două fețe

### DOMO

#### Maksymalne obciążenie:

do 125 kg

- ✓ Lekka, poręczna, bardzo wygodna w przechowywaniu oraz transporcie
- ✓ Szerokie antypoślizgowe stopnie aluminiowe
- ✓ Stopnie nitowane oraz dodatkowo osłonięte w miejscu nitowania plastikowymi osłonkami
- ✓ Najwyższej jakości aluminium polskiej produkcji, zapewnia jej wieloletnią żywotność

Aluminiowa drabina dwustronna idealnie sprawdza się w użytkowaniu na co dzień oraz do prac remontowo budowlanych w domu.



Tabela przedstawia parametry poszczególnych drabin z tej kategorii:

Numer katalogowy	Ilość stopni:	Masa:	A	B	C	G	H
120 007	2x2	1,7 kg	0,2 m	0,43 m	0,41 m	0,38 m	2,38 m
120 008	2x3	2,1 kg	0,2 m	0,67 m	0,43 m	0,61 m	2,61 m
120 009	2x4	3 kg	0,2 m	0,89 m	0,45 m	0,81 m	2,81 m
120 010	2x5	3,4 kg	0,2 m	1,14 m	0,47 m	1,03 m	3,03 m
120 011	2x6	4,1 kg	0,2 m	1,35 m	0,5 m	1,24 m	3,24 m
120 012	2x7	7,1 kg	0,2 m	1,57 m	0,52 m	1,46 m	3,46 m
120 013	2x8	8,3 kg	0,2 m	1,82 m	0,53 m	1,7 m	3,7 m

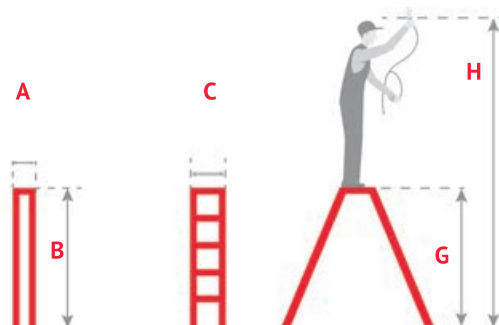
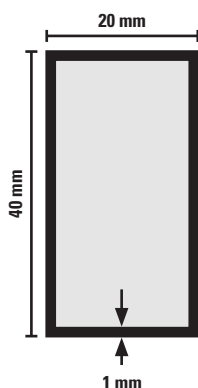

## PODEST ROBOCZY

Working platform • Рабочая платформа • Arbeitsplattform • Platforma de lucru



**Maksymalne obciążenie:**

do 150 kg

**Zgodność z europejską normą:**

EN 131



- Wodoodporna, antypoślizgowa platforma
- Szybkie składanie
- Niewielkie wymiary po złożeniu
- Antypoślizgowe stopki
- Malowane proszkowo podłużnice



Składane nożki dla łatwiejszego przechowywania



Bezpieczna blokada uniemożliwiająca niekontrolowane zamknięcie się drabiny

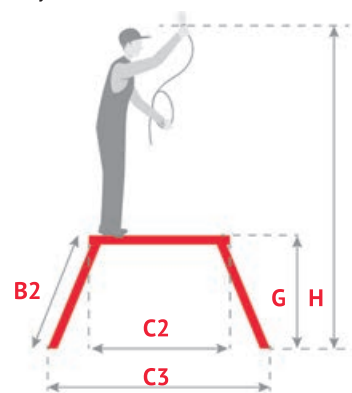
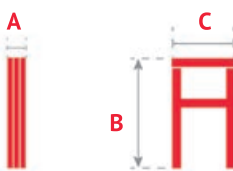

### Parametry podestu roboczego

Numer katalogowy	Ilość szczebli:	Masa:	A	B	C	B2	C2	C3	G	H
120 105	1x5	6 kg	0,10 m	0,30 m	0,40 m	0,32 m	1,15 m	1,37 m	0,30 m	2,30 m
120 124	2x4	5,8 kg	0,25 m	0,56 m	0,40 m	0,60 m	0,87 m	1,28 m	0,56 m	2,56 m
120 125	2x5	6,7 kg	0,25 m	0,56 m	0,40 m	0,60 m	1,15 m	1,56 m	0,56 m	2,56 m





## DRABINA ALUMINIOWA PRZYSTAWNA

Leaning aluminium ladders • Регулируемая алюминиевая лестница  
• Anlehnbare Aluminiumleitern



**Maksymalne obciążenie:**

do 150 kg

**Zgodność z europejską normą:**

EN 131

- Łączenie szczebli odbywa się metodą zagniatania
- Szerokie szczeble posiadają odpowiednie ryfowanie w celu zapewnienia dodatkowej stabilności o szerokości 25 mm x 25 mm
- Mocna stabilna konstrukcja gwarantuje bezpieczeństwo pracy na wysokościach
- Stopki antypoślizgowe, zabezpieczają drabinę przed przesunięciem
- Aluminium odporne na warunki atmosferyczne

Profesjonalna aluminiowa drabina przystawna, z której korzysta tysiące specjalistów w branży. Parametry drabiny dobrane są tak, by sprawdzić się w pracach na dużych wysokościach.



Tabela przedstawia parametry poszczególnych drabin z tej kategorii:



Numer katalogowy	Ilość szczebli:	Masa:	A	B	C1	C2	G	H
120 075	1x5	2,2 kg	5 cm	1,4 m	0,4 m	-	0,44 m	2,44 m
120 076	1x6	2,7 kg	5 cm	1,66 m	0,4 m	-	0,67 m	2,67 m
120 077	1x7	3,1 kg	5 cm	1,92 m	0,4 m	-	0,92 m	2,92 m
120 078	1x8	3,5 kg	5 cm	2,18 m	0,4 m	-	1,18 m	3,18 m
120 079	1x9	3,85 kg	5 cm	2,44 m	0,4 m	-	1,43 m	3,43 m
120 080	1x10	4,3 kg	5 cm	2,72 m	0,4 m	-	1,68 m	3,68 m
120 081	1x11	4,8 kg	5 cm	2,98 m	0,4 m	-	1,93 m	3,93 m
120 082	1x12	5,1 kg	5,8 cm	3,26 m	0,4 m	0,95 m	2,18 m	4,18 m
120 083	1x13	5,5 kg	5,8 cm	3,45 m	0,4 m	0,95 m	2,45 m	4,45 m
120 084	1x14	5,9 kg	5,8 cm	3,71 m	0,4 m	0,95 m	2,71 m	4,71 m

## DRABINA ALUMINIOWA PRZYSTAWNA

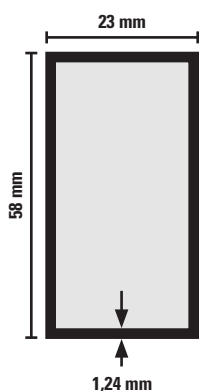
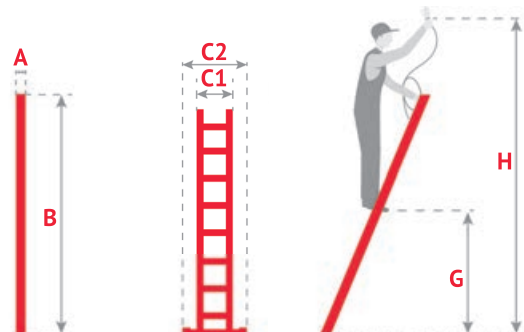
Leaning aluminium ladders • Регулируемая алюминиевая лестница  
• Anlehnbare Aluminiumleitern



### BASIC

#### Maksymalne obciążenie:

do 150 kg

#### Zgodność z europejską normą:

EN 131

- Łączenie szczebli odbywa się metodą zagniatania
- Szerokie szczeble posiadają odpowiednie ryfowanie w celu zapewnienia dodatkowej stabilności o szerokości 25 mm x 25 mm
- Mocna stabilna konstrukcja gwarantuje bezpieczeństwo pracy na wysokościach
- Stopki antypoślizgowe, zabezpieczają drabinę przed przesunięciem
- Aluminium odporne na warunki atmosferyczne

Profesjonalna aluminiowa drabina przystawna, z której korzysta tysiące specjalistów w branży. Parametry drabiny dobrane są tak, by sprawdzić się w pracach na dużych wysokościach.



Tabela przedstawia parametry poszczególnych drabin z tej kategorii:



Numer katalogowy	Ilość szczebli:	Masa:	A	B	C	G	H
120 086	1x6	2,7 kg	5 cm	1,66 m	0,4 m	0,67 m	2,67 m
120 087	1x7	3,1 kg	5 cm	1,92 m	0,4 m	0,92 m	2,92 m
120 088	1x8	3,5 kg	5 cm	2,18 m	0,4 m	1,18 m	3,18 m
120 089	1x9	3,85 kg	5 cm	2,44 m	0,4 m	1,43 m	3,43 m
120 090	1x10	4,3 kg	5 cm	2,72 m	0,4 m	1,68 m	3,68 m

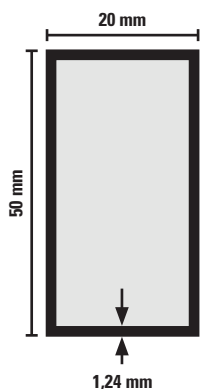
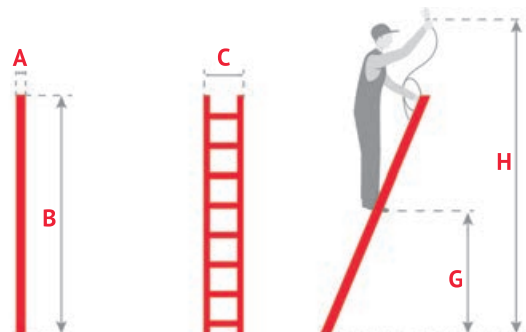

## DRABINY WIELOFUNKCYJNE - DWUELEMENTOWE

Drabina o szerokich parametrach użytkowania, sprawdzi się jako drabina rozkładana oraz rozsuwana. Świetne zestawienie jakości do ceny oraz wytrzymałości. Przeznaczona do profesjonalnej pracy przede wszystkim na dużych wysokościach. Idealne połączenie jakości do ceny oraz wytrzymałości. Produkty posiadają mocne i szerokie podłużnice o wymiarze 58 x 23 cm



Szeroki stabilizator poprzeczny, jako niezbędny element konstrukcyjny drabiny chroniący ją przed upadkiem bocznym



Haki zabezpieczające (zapadkowe) to system blokowania elementu drabiny i zabezpieczenia go przed niezamierzonym wypięciem



Dzięki odpowiednio zaprojektowanej konstrukcji prowadnic odpowiadają one za prawidłowe rozstawianie i rozsuwanie drabiny



## DRABINA ALUMINIOWA WIELOFUNKCYJNA - DWUELEMENTOWA

Double 3-Way Combination Ladder • 2x секционная алюминиевая лестница  
• Aluminium-Multifunktionsleiter 2x • Scară dubla

**motive**  
Jakość ma znaczenie

**Maksymalne obciążenie:**

do 150 kg

**Zgodność z europejską normą:**

EN 131

- Szerokie szczeble posiadają odpowiednie ryflowanie w celu zapewnienia dodatkowej stabilności o szerokości 25 mm x 25 mm
- Łączenie szczebli odbywa się metodą zagniatania
- Stopki antypoślizgowe, zabezpieczają drabinę przed przesunięciem
- Mocna stabilna konstrukcja gwarantuje bezpieczeństwo pracy na wysokościach
- Aluminium odporne na warunki atmosferyczne



Tabela przedstawia parametry poszczególnych drabin z tej kategorii:



Numer katalogowy	Ilość szczebli:	Masa:	A	B	C1	C2	E	F	G	H
120 066	2x6	7 kg	0,11 m	1,65 m	0,47 m	0,95 m	2,19 m	3,26 m	0,95 m	2,95 m
120 067	2x7	7,3 kg	0,11 m	1,91 m	0,47 m	0,95 m	2,96 m	3,99 m	1,2 m	3,19 m
120 069	2x9	9,2 kg	0,11 m	2,43 m	0,47 m	0,95 m	3,75 m	4,75 m	1,71 m	3,71 m
120 070	2x10	10 kg	0,11 m	2,7 m	0,47 m	0,95 m	4,03 m	5,12 m	1,98 m	3,98 m
120 071	2x11	10,7 kg	0,11 m	2,97 m	0,47 m	0,95 m	4,55 m	5,49 m	2,2 m	4,2 m

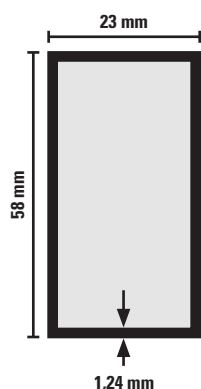
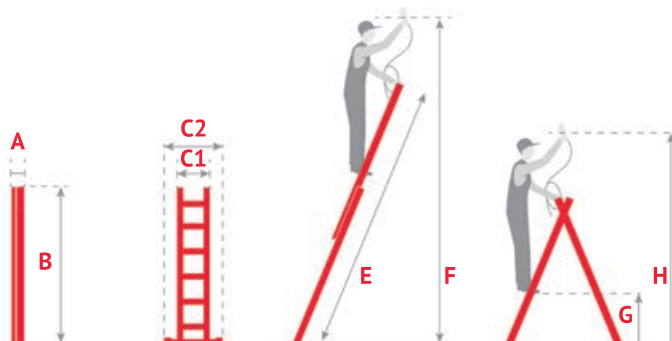

## DRABINA ALUMINIOWA WIELOFUNKCYJNA-TRÓJELEMENTOWA

Triple 3-Way Combination Ladder • 3x секционная алюминиевая лестница  
• Aluminium-Multifunktionsleiter 3x • Scară tripla



**Maksymalne obciążenie:**

do 150 kg

**Zgodność z europejską normą:**

EN 131

- Szerokie szczeble posiadają odpowiednie ryfowanie w celu zapewnienia dodatkowej stabilności o szerokości 25 mm x 25 mm
- Łączenie szczebli odbywa się metodą zagniatania
- Stopki antypoślizgowe, zabezpieczają drabinę przed przesunięciem
- Mocna stabilna konstrukcja gwarantuje bezpieczeństwo pracy na wysokościach
- Aluminium odporne na warunki atmosferyczne



Tabela przedstawia parametry poszczególnych drabin z tej kategorii:



Numer katalogowy	Ilość szczebli:	Masa:	A	B	C	D	D2	E	F	G	H	I	J
120 306	3x6	9,6 kg	0,15 m	1,65 m	0,95 m	2,45 m	2,96 m	0,95 m	2,95 m	0,95 m	2,95 m	1,69 m	3,69 m
120 020	3x7	10,7 kg	0,15 m	1,91 m	0,95 m	2,7 m	3,76 m	1,45 m	3,45 m	1,2 m	3,2 m	2,59 m	4,59 m
120 021	3x8	12,2 kg	0,15 m	2,17 m	0,95 m	3,5 m	4,55 m	1,96 m	3,96 m	1,45 m	3,45 m	3,53 m	5,53 m
120 022	3x9	14,4 kg	0,15 m	2,43 m	0,95 m	3,75 m	5,12 m	2,21 m	4,21 m	1,7 m	3,7 m	4,03 m	6,03 m
120 023	3x10	14,8 kg	0,15 m	2,7 m	0,95 m	4,03 m	5,37 m	2,75 m	4,75 m	1,98 m	3,98 m	4,28 m	6,28 m
120 024	3x11	16 kg	0,15 m	2,97 m	0,95 m	4,55 m	5,62 m	3,24 m	5,24 m	2,2 m	4,2 m	4,52 m	6,52 m
120 312	3x12	21 kg	0,185 m	3,17 m	1,1 m	5,3 m	7,15 m	3,85 m	5,85 m	2,35 m	4,35 m	6 m	8 m
120 313	3x13	22,5 kg	0,185 m	3,44 m	1,1 m	5,85 m	7,95 m	4,35 m	6,33 m	2,6 m	4,6 m	6,75 m	8,75 m
120 314	3x14	25 kg	0,185 m	3,7 m	1,2 m	6,35 m	8,75 m	4,6 m	6,6 m	2,85 m	4,85 m	7,52 m	9,5 m
120 315	3x15	28 kg	0,185 m	3,95 m	1,2 m	7,15 m	10,3 m	5,25 m	7,2 m	3,1 m	5,1 m	8,75 m	10,7 m

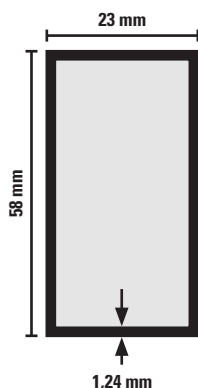
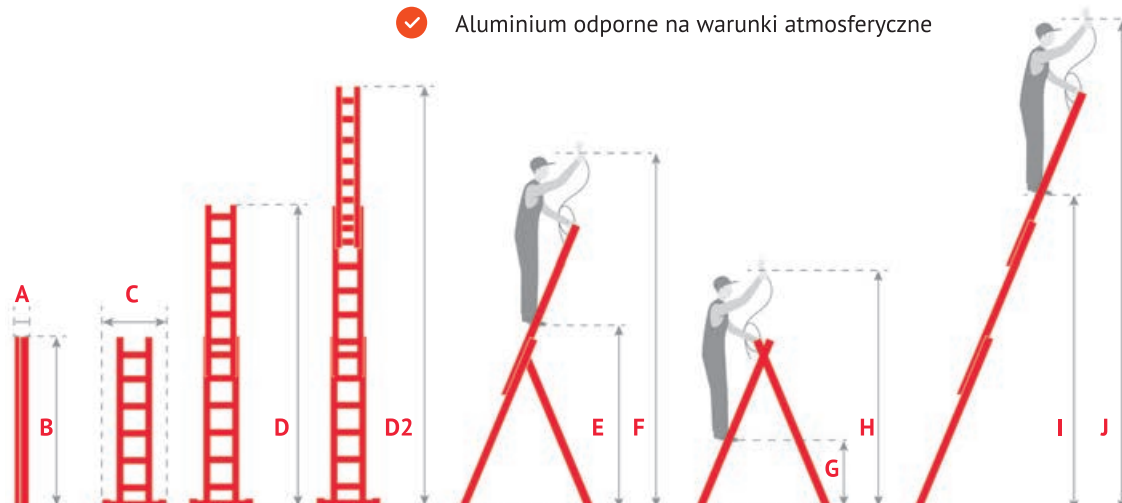

## DRABINA ALUMINIOWA WIELOFUNKCYJNA-TRÓJELEMENTOWA

Triple 3-Way Combination Ladder • 3x секционная алюминиевая лестница  
• Aluminium-Multifunktionsleiter 3x • Scară tripla

### BASIC

**Maksymalne obciążenie:**

do 150 kg

**Zgodność z europejską normą:**

EN 131

- ✓ Szerokie szczeble posiadają odpowiednie ryflowanie w celu zapewnienia dodatkowej stabilności o szerokości 25 mm x 25 mm
- ✓ Łączenie szczebli odbywa się metodą zagniatania
- ✓ Stopki antypoślizgowe, zabezpieczają drabinę przed przesunięciem
- ✓ Mocna stabilna konstrukcja gwarantuje bezpieczeństwo pracy na wysokościach
- ✓ Aluminium odporne na warunki atmosferyczne



Drabina o szerokich parametrach użytkowania, sprawdzi się jako drabina przystawna, rozkładana oraz rozsuwana. Przeznaczona do profesjonalnej pracy przede wszystkim na dużych wysokościach. Idealne połączenie jakości do ceny oraz wytrzymałości. Produkty posiadają mocne i szerokie podłużnice o wymiarze 50 x 20 centymetrów

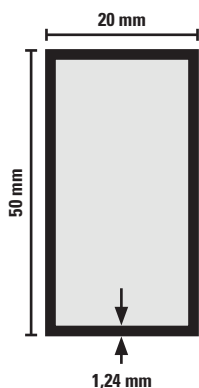

Szeroki stabilizator poprzeczny, jako niezbędny element konstrukcyjny drabiny chroniący ją przed upadkiem bocznym



Tabela przedstawia parametry poszczególnych drabin z tej kategorii:

Numer katalogowy	Ilość szczebli:	Masa:	A	B	C	D	D2	E	F	G	H	I	J
120 017	3x6	7,85 kg	0,15 m	1,65 m	0,95 m	2,45 m	2,96 m	0,95 m	2,95 m	0,95 m	2,95 m	1,69 m	3,69 m
120 018	3x7	8,95 kg	0,15 m	1,91 m	0,95 m	2,7 m	3,76 m	1,45 m	3,45 m	1,2 m	3,2 m	2,59 m	4,59 m
120 058	3x8	10,5 kg	0,15 m	2,17 m	0,95 m	3,5 m	4,55 m	1,96 m	3,96 m	1,45 m	3,45 m	3,53 m	5,53 m
120 019	3x9	11,1 kg	0,15 m	2,43 m	0,95 m	3,75 m	5,12 m	2,21 m	4,21 m	1,7 m	3,7 m	4,03 m	6,03 m
120 037	3x11	16 kg	0,15 m	2,97 m	0,95 m	4,55 m	5,62 m	3,24 m	5,24 m	2,2 m	4,2 m	4,52 m	6,52 m

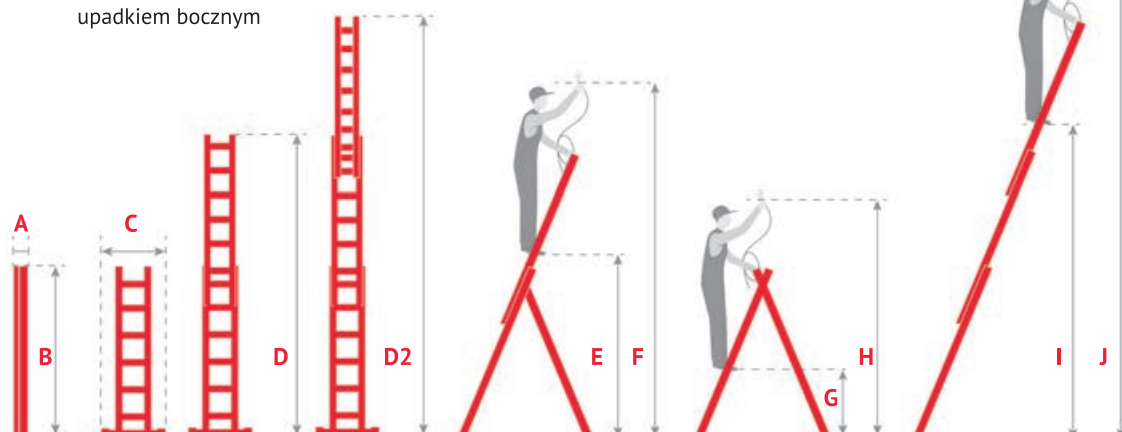

## WIELOZADANIOWY PODEST ALUMINIOWY Z PLATFORMĄ rusztowanie / drabina przystawna / drabina wolnostojąca

4 - function scaffolding ladder with platform • Лестница-помост алюминиевая  
• 4- Funktion Gerustleiter mit Plattform • Scară si schela cu platforma



### Maksymalne obciążenie:

do 150 kg

### Zgodność z europejską normą:

EN 131

- Aluminiowe drabino - rusztowanie montażowe przeznaczone do lekkich prac na wysokościach
- Uniwersalna, lekka konstrukcja
- Podest o wymiarach 114 x 33 cm
- Barierka BHP
- Platforma antypoślizgowa + 2 stalowe wsporniki platformy
- Urządzenie typu 3 w 1 (mini rusztowanie, drabina przystawna i drabina wolnostojąca)
- Wymiary po złożeniu do transportu:  
Dla modelu 2x6: 46x14x164 cm  
Dla modelu 2x7: 46x14x188 cm  
Dla modelu 2x8: 46x14x215 cm



Tabela przedstawia parametry poszczególnych rusztowań z tej kategorii

Numer katalogowy	Ilość szczebli:	Masa:	A	B	C	D	E	F
120 030	2x6	11,5 kg	0,96 m	2,96 m	1,53 m	2,83 m	2,38 m	3,68 m
120 031	2x7	12 kg	0,96 m	2,96 m	1,85 m	2,95 m	2,93 m	4,2 m
120 032	2x8	21 kg	0,96 m	2,96 m	2,03 m	3,33 m	3,42 m	4,72 m

## DRABINY PRZEGUBOWE

Drabina aluminiowa przegubowa 4x3 z podestem - to najbardziej uniwersalna drabina dostępna na naszym rynku. Drabina może być używana jako podest roboczy (podest antypoślizgowy w zestawie), drabina wolnostojąca oraz jako drabina przystawna. Największą zaletą drabiny jest jej wielofunkcyjność oraz kompaktowe rozmiary po złożeniu.

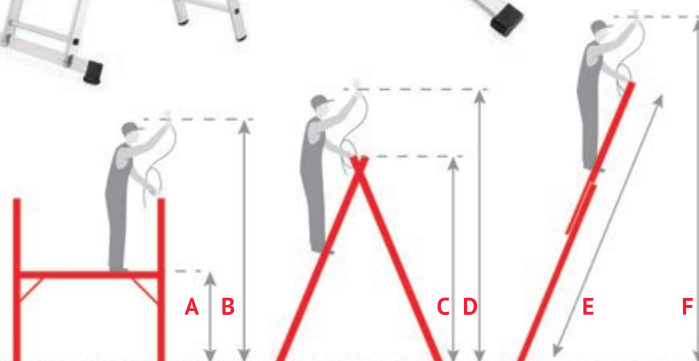
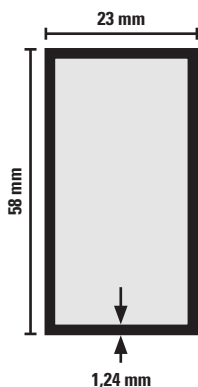

Podest ze sklejki antypoślizgowej



## DRABINA PRZEGUBOWA

Multi purpose ladder • Универсальная лестница • Mehrzweckleiter  
• Scară articulată



**Maksymalne obciążenie:**

do 150 kg

**Zgodność z europejską normą:**

EN 131

- Mocne podłużnice aluminiowe o rozmiarze 60 x 25 mm
- Samoblokujące się zawiasy, umożliwiające pracę w każdej konfiguracji rozłożenia drabiny
- Antypoślizgowe, ryflowane szczeble, podnoszą stabilność konstrukcji
- Szczeble łączone z pobocznicy metodą tłoczenia
- Wielofunkcyjność: 4 różne warianty ułożenia
- 2 szerokie stabilizatory



Mocne stalowe przeguby które umożliwiają płynne i szybkie zmienianie pozycji drabiny



Drabina wyposażona jest w dwa stabilizatory zapewniające bezpieczną pracę



Tabela przedstawia parametry poszczególnych drabin z tej kategorii:



Numer katalogowy	Ilość szczebli:	Masa:	A	B	C	D	E
120 026	4x3	10 kg	-	1,70 m	3 m	3,40 m	4,40 m
120 027	4x3 z podestem	12 kg	2,95 m	1,70 m	3 m	3,40 m	4,40 m

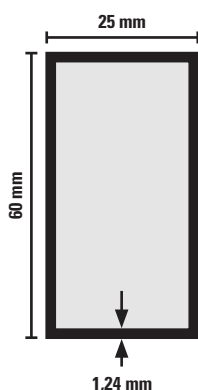
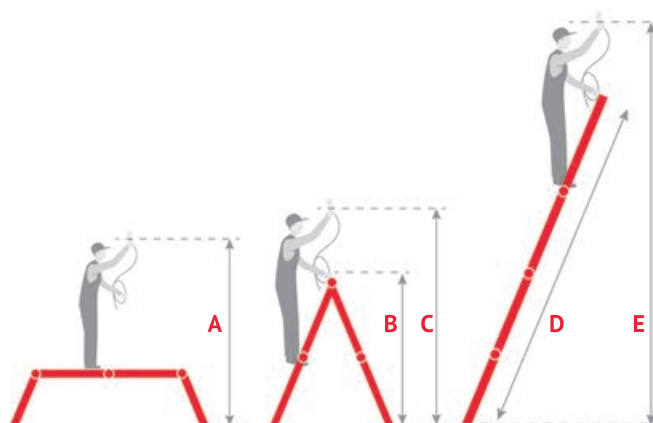

**motive**   
Jakość ma znaczenie

**KOZIOŁEK DREWNIANY**

Wooden folding trestle • Деревянные козлы • Klappbock  
• Banc [capra] de lucru din lemn

NUMER  
KATALOGOWY

MAX  
kg



090 011

120 kg

70 cm

79 cm

1/30



**motive**   
Jakość ma znaczenie

**DRABINA DREWNIANA**

Wooden ladder • Лестница деревянная • Holzleiter • Scara dubla din lemn

NUMER  
KATALOGOWY

MAX  
kg



090 354

150 kg

4

120 cm

1/3/24

090 355

150 kg

5

145 cm

1/2/24

090 356

150 kg

6

172 cm

1/24

090 357

150 kg

7

200 cm

1/24

090 359

150 kg

9

253 cm

1

**DRABINA DREWNIANA**

Wooden ladder • Лестница деревянная • Holzleiter • Scara dubla din lemn

NUMER  
KATALOGOWY

MAX  
kg



090 340

150 kg

4

120 cm

1/3/24

090 341

150 kg

5

145 cm

1/2/24



# ARTYKUŁY OGRODNICZE

GARDENING EQUIPMENT • ИНСТРУМЕНТЫ ДЛЯ САДА И ОГОРОДА • GARTENWERKZEUGE  
• UNELTE PENTRU GRADINA







### WAŻ OGRODOWY BOS PLUS

Garden Hose "BOS PLUS" • Садовый шланг "BOS PLUS"  
• Gartenschlauch "BOS PLUS" • Furtun de gradina Bos Plus



NUMER KATALOGOWY			
100 600	1/2"	20 m	1
100 601	3/4"	20 m	1



### WAŻ OGRODOWY CARBON PLUS

Garden Hose "CARBON PLUS" • Садовый шланг "CARBON PLUS"  
• Gartenschlauch "CARBON PLUS" • Furtun de gradina Carbon Plus



NUMER KATALOGOWY			
100 605	3/4"	20 m	1
100 606	1/2"	20 m	1



### WAŻ OGRODOWY ROZCIĄGLIWY

Expandable garden hose • Садовый шланг растягивающийся  
• Flexibler Gartenschlauch • Furtun de gradina

NUMER KATALOGOWY			
100 610		5 - 15 m	1/12
100 611		7,5 - 22,5 m	1/8
100 612		10 - 30 m	1/8

**motive**  
Jakość ma znaczenie



### WIESZAK ŚCIENNY NA WAŻ

Garden hose hanger • Вешалка для садового шланга • Gartenschlauch Bügel

NUMER KATALOGOWY	
100 595	1/6



### WIESZAK ŚCIENNY NA WAŻ RE-TRO

Garden hose hanger • Вешалка для садового шланга • Gartenschlauch Bügel

NUMER KATALOGOWY	
R8001	1



### ZWIJACZ BĘBNOWY AUTOMATYCZNY

Automatic hose reel • Катушка со шлангом автоматическая, шланг 20м  
• Automatische Schlauchtrommel • Tambur automat pentru furtun

NUMER KATALOGOWY			
100 593	1/2"	20 m	1

**motive**  
Jakość ma znaczenie





### NIEZBĘDNIK OGRODOWY

Garden set • Набор: шланг, катушка, переходники, коннектор  
• Gartenschlauch Bügel. • Kit pentru irigații

NUMER  
KATALOGOWY



100 592

15 m

1



### ZWIJACZ DO WĘŻA OGRODOWEGO

Hose reel • Катушка для садового шланга • Aufroller für Gartenschlauch

NUMER  
KATALOGOWY



100 630

1/6



### SZYBKOZŁĄCZKA NA WĄŻ - AQUA STOP

Hose connector with water stop • Быстроразъемное соединение для шланга  
AQUA STOP • Schlauchverbinder AQUA STOP • Conector furtun AQUA STOP

NUMER  
KATALOGOWY



100 501

1/2"

10

100 503

3/4"

10



### SZYBKOZŁĄCZKA NA WĄŻ - COMFORT

Hose connector • Быстроразъемное соединение для шланга COMFORT  
• Schlauchverbinder COMFORT • Conector furtun COMFORT

NUMER  
KATALOGOWY



100 502

1/2"

10

100 504

3/4"

10



### SZYBKOZŁĄCZKA NA WĄŻ RE-TRO

Hose connector • Быстроразъемное соединение для шланга RE-TRO  
• Schlauchverbinder RE-TRO • Conector furtun RE-TRO

NUMER  
KATALOGOWY



R8142

1/2"

10

R8143

3/4"

10



### SZYBKOZŁĄCZKA NA WĄŻ AGROCAL

Hose connector • Быстроразъемное соединение для шланга AGROCAL  
• Schlauchverbinder AGROCAL • Conector AGROCAL

NUMER  
KATALOGOWY



100 505



1"

10





#### PRZYŁĄCZE NA KRAN Z GWINTEM WEWNĘTRZNYM

Threaded tap connector • Штуцер на кран с внутренней резьбой  
• Hahnverbinder • Conector robinet, filet interior

NUMER KATALOGOWY		
100 511	3/4"	25
100 510	1"	25



#### PRZYŁĄCZE NA KRAN Z GWINTEM ZEWNĘTRZNYM

Threaded tap connector (outside thread) • Штуцер с наружной резьбой  
• Hahnanschluss mit Außengewinde • Conector robinet, filet exterior

NUMER KATALOGOWY		
100 512	1/2"	25
100 513	3/4"	25

#### PRZYŁĄCZE AGROCAL Z GWINTEM ZEWNĘTRZNYM

Threaded tap connector • Штуцер на кран с наружной резьбой  
• Hahnverbinder • Conector robinet, filet interior

NUMER KATALOGOWY		
100 515	3/4" - 1"	10
100 514	1" - 1"	10

#### PRZYŁĄCZE Z GWINTEM ZEWNĘTRZNYM RE-TRO

Threaded tap connector • Штуцер на кран с наружной резьбой  
• Hahnverbinder • Conector robinet, filet interior

NUMER KATALOGOWY		
R8115	3/4"	10

#### PRZYŁĄCZE AGROCAL Z GWINTEM WEWNĘTRZNYM

Threaded tap connector • Штуцер на кран с внутренней резьбой  
• Hahnverbinder • Conector robinet, filet interior

NUMER KATALOGOWY		
100 516	1" - 1"	10
100 517	5/4"	10

#### PRZYŁĄCZE REDUKCYJNE

1" threaded tap connector with reducing connector 3/4" • Штуцер на кран с внутренней резьбой 1" • Anschluß für Wasserhahn mit Innengewinde 1"

NUMER KATALOGOWY		
100 518	1" - 3/4"	12



**RAMP**  
Retro  
LINE





**motive**  
Jakość ma znaczenie

**PRZYŁĄCZE NA KRAN Z GWINTEM WEWNĘTRZNYM**

Threaded tap connector • Штуцер на кран с внутренней резьбой  
• Hahnverbinder • Conector robinet, filet interior

NUMER KATALOGOWY		
100 519	1/2"	25



**RAMP**  
Retro  
LINE



**PRZYŁĄCZE RE-TRO NA KRAN Z GWINTEM WEWNĘTRZNYM**

Threaded tap connector • Штуцер на кран с внутренней резьбой  
• Hahnverbinder • Conector robinet, filet interior

NUMER KATALOGOWY		
R8113	3/4"	25
R8111	1"	25



**REDUKCJA PRZYŁĄCZA**

Reducing connector • Переходник соединение • Reducce

NUMER KATALOGOWY		
100 521	1" → 3/4"	25
100 520	3/4" → 1/2"	25



**motive**  
Jakość ma znaczenie

**ŁĄCZNIK DO WĘŻA**

Hose connector • Соединитель для шланга • Reparatör • Conector 2 furtunuri

NUMER KATALOGOWY		
100 525	1/2"	10
100 526	3/4"	10



**RAMP**  
Retro  
LINE



**ŁĄCZNIK DO WĘŻA RE-TRO**

Hose connector • Соединитель для шланга • Reparatör • Conector 2 furtunuri

NUMER KATALOGOWY		
R8152	1/2"	10
R8153	3/4"	10



**ŁĄCZNIK REDUKCYJNY SZYBKOZŁĄCZEK AGROCAL I STANDARD**

Hose connector • Соединитель понижающий • Reparatör • Conector 2 furtunuri

NUMER KATALOGOWY		
100 527	AGROCAL → 1/2" - 3/4"	10



**ŁĄCZNIK REDUKCYJNY**

Hose connector • Соединитель понижающий с 1/2" на 3/4"  
• Reparatör • Conector 2 furtunuri

NUMER KATALOGOWY		
100 528	1/2" - 3/4"	10



**ŁĄCZNIK REDUKCYJNY RE-TRO**

Hose connector • Соединитель понижающий с 1/2" на 3/4"  
• Reparatör • Conector 2 furtunuri

NUMER KATALOGOWY		
R8150	1/2" - 3/4"	10

**ŁĄCZNIK SZYBKOZŁĄCZEK**

Double-ended hose connector • Соединитель быстроразъемных соединений  
• Kupplung • Conector 2 cuple

NUMER KATALOGOWY		
100 533	1/2"	25
100 534	3/4"	25

**ŁĄCZNIK SZYBKOZŁĄCZEK**

Double-ended hose connector • Соединитель быстроразъемных соединений  
• Kupplung • Conector 2 cuple

NUMER KATALOGOWY		
100 529	1/2" - 3/4"	25

**ŁĄCZNIK SZYBKOZŁĄCZEK RE-TRO**

Double-ended hose connector • Соединитель быстроразъемных соединений  
• Kupplung • Conector 2 cuple

NUMER KATALOGOWY		
R8120	1/2" - 3/4"	25

**ŁĄCZNIK SZYBKOZŁĄCZEK AGROCAL**

Double-ended hose connector • Соединитель быстроразъемных соединений  
• Kupplung • Conector 2 cuple

NUMER KATALOGOWY		
100 530	1"	10





### ŁĄCZNIK AGROCAL

Double-ended hose connector • Соединитель быстроразъемных соединений  
• Kupplung • Conector 2 cuple

NUMER  
KATALOGOWY

100 531



1"



10



### ŁĄCZNIK REDUKCYJNY AGROCAL

Double-ended hose connector • Соединитель быстроразъемных соединений  
• Kupplung • Conector 2 cuple

NUMER  
KATALOGOWY

100 532



1" - 3/4"



10



### TRÓJNIK

Y hose connector • Тройник • Y-Stück • Conector Y

NUMER  
KATALOGOWY

100 535



3x1/2" - 3/4"



10



**RAMP**  
Retro  
LINE



### TRÓJNIK RE-TRO

Y hose connector • Тройник • Y-Stück • Conector Y

NUMER  
KATALOGOWY

R8130



3x1/2" - 3/4"



10



### TRÓJNIK AGROCAL

Y hose connector • Тройник • Y-Stück • Conector Y

NUMER  
KATALOGOWY

100 536



1"



10



### TRÓJNIK REDUKCYJNY AGROCAL

Y hose connector • Тройник • Trišakis • Y-Stück • Conector Y

NUMER  
KATALOGOWY

100 537



1" → 2x1/2"



10





### TRÓJNIK Z DWOMA ZAWORAMI

2 way splitter • Тройник с двумя клапанами с резьбой 1" с переходом  
штуцера • 2-Wege-Ventil • Conector robinet, 2 ramificatii cu robinet

NUMER  
KATALOGOWY

100 538



1" → 2x3/4"

10



### ROZDZIELACZ Z ZAWORAMI

4 way Tap connector with Valves • Присоединение - Распределитель  
с клапанами • Anschluß - Verteiler mit Ventilen

NUMER  
KATALOGOWY

100 539



3/4" → 1/2" - 3/4"

10

**motive**  
Jakość ma znaczenie

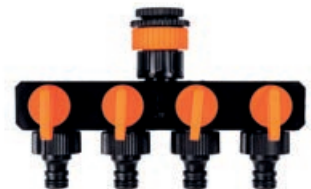

### PISTOLET DO ZRASZANIA ERGO

Spray pistol Ergo • Пистолет для поливки Ergo • Bewässerungsbrause Ergo  
• Pistol de stropit Ergo

NUMER  
KATALOGOWY

100 540



1/2"

1/12/48

**motive**  
Jakość ma znaczenie



### PISTOLET DO ZRASZANIA ERGO-SPEC

Spray pistol Ergo-Spec • Пистолет для поливки Ergo-Spec  
• Bewässerungsbrause Ergo-Spec • Pistol de stropit Ergo-Spec

NUMER  
KATALOGOWY

100 541



1/2"

1/48



### PISTOLET DO ZRASZANIA WIELOFUNKCYJNY - PROFİ

Spray pistol PROFİ • Пистолет для поливки многофункциональный PROFİ  
• Bewässerungsbrause Profi • Pistol de stropit Profi

NUMER  
KATALOGOWY

100 542



1/2"

1/12/48





**PISTOLET ZRASZAJĄCY PROSTY**

Spray pistol • Пистолет для поливки • Bewässerungsbrause • Pistol de stropit

NUMER  
KATALOGOWY



100 543

1/2"

1



**PISTOLET ZRASZAJĄCY POLO RE-TRO**

Spray pistol • Пистолет для поливки • Bewässerungsbrause • Pistol de stropit

NUMER  
KATALOGOWY



R8408

1/2"

1



**PISTOLET ZRASZAJĄCY POLKA RE-TRO**

Spray pistol • Пистолет для поливки • Bewässerungsbrause • Pistol de stropit

NUMER  
KATALOGOWY



R8409

1/2"

1



**KOŃCÓWKA ZRASZAJĄCA**

Hose spray nozzle • Наконечник поливочный • Schlauchspritze  
• Duza de stropit

NUMER  
KATALOGOWY



100 544

1/2"

1/10



**KOŃCÓWKA ZRASZAJĄCA Z REGULACJĄ STRUMIENIA RE-TRO**

Hose spray nozzle • Наконечник поливочный • Schlauchspritze  
• Duza de stropit

NUMER  
KATALOGOWY



R8210

1"

10



### KOŃCÓWKA ZRASZAJĄCA SITKO

Jet spray nozzle with strainer • Распылительный наконечник с ситом  
• Sprühspitze mit Sieb

NUMER KATALOGOWY		
100 546	1/2"	12



### KOŃCÓWKA ZRASZAJĄCA SITKO RE-TRO

Jet spray nozzle with strainer • Распылительный наконечник с ситом  
• Sprühspitze mit Sieb



NUMER KATALOGOWY		
R8211	1/2"	12

**RAMP**  
Retro  
LINE



### ZESTAW ZRASZAJĄCY DO WĘŻA RE-TRO

Sprinkler kit for hose • Распылительный наконечник с ситом  
• Gartenschlauchzubehör, 3-tlg. Satz • Kit furtun pentru gradina

NUMER KATALOGOWY		
R8512	1/2"	12
R8513	3/4"	12

**RAMP**  
Retro  
LINE



### KOŃCÓWKA ZRASZAJĄCA AGROCAL

Hose spray nozzle Agrocal • Наконечник поливочный Agrocal  
• Schlauchspritze Agrocal • Duza de stropit Agrocal

NUMER KATALOGOWY		
100 545	1"	10



### ZRASZACZ NA PODSTAWIE WBIJANEJ

Sprinkler on spike • Дождеватель на подставке устанавливаемой в грунт • Kreisregner • Aspersor circular, cu spin

NUMER KATALOGOWY	
100 556	1





**RAMP**  
Retro  
LINE



#### ZRASZACZ NA PODSTAWIE WBIJANEJ RE-TRO

Sprinkler on spike • Дождеватель на подставке устанавливаемой в грунт • Kreisregner • Aspensor circular, cu spin

NUMER  
KATALOGOWY



R8310

1



**motive**  
Jakość ma znaczenie

#### ZRASZACZ PULSACYJNY

Impulse sprinkler • Дождеватель импульсный пластиковый с запасными соплами • Impuls-, Kreis- und Sektorenregnerkop • Aspensor plastic, cu tarus

NUMER  
KATALOGOWY



100 557

12



#### ZRASZACZ PULSACYJNY - PLASTIK

Impulse sprinkler • Дождеватель импульсный пластиковый с запасными соплами • Impuls-, Kreis- und Sektorenregnerkop • Aspensor plastic, cu tarus

NUMER  
KATALOGOWY



RT 1340

1/30



**RAMP**  
Retro  
LINE



#### ZRASZACZ OMEGA NA PODSTAWIE WBIJANEJ

Rotating sprinkler on spike • Дождеватель вращающийся на подставке устанавливаемой в грунт • Drehsprinkler auf Einschlaggestell

NUMER  
KATALOGOWY



RT 8371

1/30



**motive**  
Jakość ma znaczenie

#### ZRASZACZ OBROTOWY TRÓJRAMIENNY

Rotating sprinkler on spike • Дождеватель вращающийся на подставке устанавливаемой в грунт • Drehsprinkler auf Einschlaggestell

NUMER  
KATALOGOWY



100 559

1/30



**motive**  
Jakość ma znaczenie

#### ZRASZACZ PULSACYJNY METALOWY

Rotating sprinkler on spike • Дождеватель вращающийся на подставке устанавливаемой в грунт • Drehsprinkler auf Einschlaggestell

NUMER  
KATALOGOWY



100 558

1/30



**ZRASZACZ OBROTOWY WOLNOSTOJĄCY**

Rotating sprinkler on stand • Дождеватель вращающийся на стоящей подставке • Drehsprinkler auf Stehgestel

NUMER  
KATALOGOWY



100 549

1/12

**motive**  
Jakość ma znaczenie



**ZRASZACZ BZYK RE-TRO WOLNOSTOJĄCY**

Rotating sprinkler on stand • Дождеватель вращающийся на стоящей подставке • Drehsprinkler auf Stehgestel

NUMER  
KATALOGOWY



R8315

1/15

**RAMP**  
Retro  
LINE



**ZRASZACZ OBROTOWY OMEGA WOLNOSTOJĄCY**

Rotating sprinkler on stand • Дождеватель вращающийся на стоящей подставке • Drehsprinkler auf Stehgestel

NUMER  
KATALOGOWY



100 551

1/12



**ZRASZACZ OBROTOWY OMEGA RE-TRO WOLNOSTOJĄCY**

Rotating sprinkler on stand • Дождеватель вращающийся на стоящей подставке • Drehsprinkler auf Stehgestel

NUMER  
KATALOGOWY



R8370

1/10

**RAMP**  
Retro  
LINE



**ZRASZACZ OBROTOWY NA PODSTAWIE WBIJANEJ**

Rotating sprinkler on spike • Дождеватель вращающийся на подставке устанавливаемой в грунт • Drehsprinkler auf Einschlaggestell

NUMER  
KATALOGOWY



100 553

1/6/60



**ZRASZACZ OBROTOWY WOLNOSTOJĄCY**

Rotating sprinkler on stand • Дождеватель вращающийся на стоящей подставке • Drehsprinkler auf Stehgestel

NUMER  
KATALOGOWY



100 552

1/20





#### ZRASZACZ WAHADŁOWY PLUS 15

Oscillating sprinkler • Дождеватель осциллирующий PLUS 15 сопел  
• Viereckregner mit 15 Düsen • Aspersor, oscilant, raza reglabila

NUMER  
KATALOGOWY



RT 1363

15 dysz

1/12



#### ZRASZACZ WAHADŁOWY ELEGANCE

Oscillating sprinkler • Дождеватель осциллирующий ELEGANCE  
• Viereckregner mit 17 Düsen • Aspersor, oscilant, raza reglabila

NUMER  
KATALOGOWY



100 555

17 dysz

10



#### ZRASZACZ WAHADŁOWY

Oscillating sprinkler • Дождеватель осциллирующий • Viereckregner • Aspersor, oscilant, raza reglabila

NUMER  
KATALOGOWY



100 550

17 dysz

1/6/24



#### GRABKI 5-ZĘBNE METALOWE

Garden rakes • Грабли • Fächerbesen • Grebla

NUMER  
KATALOGOWY



100 570

1



#### GRABKI LONG METALOWE

Garden rakes • Грабли • Fächerbesen • Grebla

NUMER  
KATALOGOWY



100 570

1



### GRABKI

Small garden rakes • Грабли • Kleinfächerbesen • Minigrebla



NUMER  
KATALOGOWY



100 570

55 cm

1

### ŁOPATKA SZEROKA METALOWA

Garden trowel • Лопатка универсальная • Blumenkelle  
• Scafa ingusta pentru flori



NUMER  
KATALOGOWY



100 710

1/20

### ŁOPATKA METALOWA

Garden trowel • Лопатка универсальная • Blumenkelle  
• Scafa ingusta pentru flori



NUMER  
KATALOGOWY



100 711

1/20

### ŁOPATKA UNIWERSALNA

Garden trowel • Лопатка универсальная • Blumenkelle  
• Scafa ingusta pentru flori



NUMER  
KATALOGOWY



100 571

30 cm

1/20

### MOTYCZKO-GRABKI

Dual-use hoe - cultivator • Культиватор - грабли • Doppelhacke • Sapaliga



NUMER  
KATALOGOWY



100 572

1/30

### MOTYCZKA METALOWA

Hoe • Мотыга • Hacke • Sapă



NUMER  
KATALOGOWY



100 714

1/30



**motive**  
Jakość ma znaczenie



**MOTYCZKO-GRABKI METALOWE**

Dual-use hoe - cultivator • Культиватор - грабли • Doppelhacke • Sapaliga

NUMER  
KATALOGOWY



100 712

1/30



**PAZURKI - KULTYWATOR**

Cultivator • Когти - культиватор • Handgrubber • Cultivator pentru gradinarit

NUMER  
KATALOGOWY



100 574

28 cm

1/20



**motive**  
Jakość ma znaczenie



**PAZURKI - KULTYWATOR METALOWE**

Cultivator • Когти - культиватор • Handgrubber • Cultivator pentru gradinarit

NUMER  
KATALOGOWY



100 713

1/20



**WIDEŁKI**

Fork • Вилка • Pflanzgabel • Mini-furca

NUMER  
KATALOGOWY



100 581

28 cm

1/20



**motive**  
Jakość ma znaczenie



**WIDEŁKI METALOWE**

Fork • Вилка • Pflanzgabel • Mini-furca

NUMER  
KATALOGOWY



100 715

1/25



**PIKOWNIK**

Dibber • Посадочный конус • Pflanzholz • Plantator

NUMER  
KATALOGOWY



100 575

18 cm

1/25





### RĘKAWICE Z PAZURKAMI

Garden gloves with claws • Перчатки садовые с когтями  
• Gartenhandschuhe mit Klauen



NUMER  
KATALOGOWY



100 620

5/200

### ZESTAW 3 NARZĘDZI OGRODNICZYCH

Set of 3 Tools • Набор из 3 инструментов • Satz von 3 Werkzeugen



NUMER  
KATALOGOWY



100 590

1/7

### AUTOMATYCZNY WIESZAK NA 9 NARZĘDZI

Hanger 9 tools • Вешалка 9 инструментов • Gerätehalter für 9 Geräte



NUMER  
KATALOGOWY



100 596

1/15

### SIEWNIK RĘCZNY

Handheld rotary spreader • Разбрасыватель-сеялка • Handspreizer



NUMER  
KATALOGOWY



100 625

1/6

### KOSZYK NA OWOCE

Fruit basket • Корзина на фрукты • Obstkorb



NUMER  
KATALOGOWY



100 582

1/18



### SZPILKA DO AGROWŁÓKNINY

Fixing anchors • Булавка для агроволокна • Nadel zum Gartenvlies

NUMER KATALOGOWY		↔	
100 585	50 szt.	12,5 cm	50
100 586	50 szt.	20 cm	50
100 587	100 szt.	12,5 cm	100



KLIK

CLICK



### GRABIE DO LIŚCI - POMARAŃCZOWE

Plastic leaf rake • Грабли размер M • Laubharke • Grebla plastic M

NUMER KATALOGOWY		↔	
100 560	M	45 cm	1/70



KLIK

CLICK



### GRABIE DO LIŚCI - POMARAŃCZOWE

Plastic leaf rake • Грабли размер L • Laubharke • Grebla plastic L

NUMER KATALOGOWY		↔	
100 561	L	50 cm	1/50



KLIK

CLICK



### GRABIE DO LIŚCI - POMARAŃCZOWE

Plastic leaf rake • Грабли размер XL • Laubharke • Grebla plastic XL

NUMER KATALOGOWY		↔	
100 562	XL	59 cm	1/20

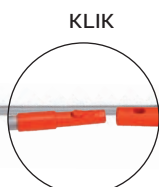
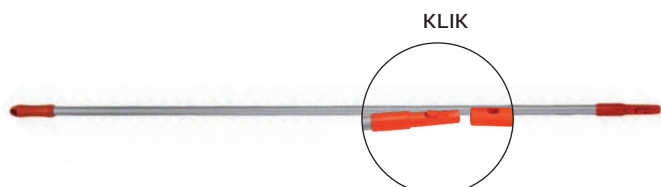

KLIK

CLICK

### KIJ ALUMINIOWY Z MOCOWANIEM KLIK



Aluminum pole with Click connector • Щетка для газонокосилки  
• Alustiel • Coada pentru grebla plastic

NUMER KATALOGOWY			↔	
100 563		24 mm	140 cm	1/10



#### GRABIE HARTOWANE

Steel rake • Грабли • Rechen aus Metall • Grebla cu coada metalica



NUMER KATALOGOWY		
040 508	14	1/5
040 509	16	1/5

**motive**  
Jakość ma znaczenie



#### GRABIE NIEOPRAWNE

Garden rake replacement head • Грабли • Rechen aus Metall • Grebla fara coada

NUMER KATALOGOWY		
040 501	14	1/10
040 502	16	1/10



#### KIJ DO GRABI

Pole for rake • Черенок для граблей • Rechenstiel • Coada pentru grebla

NUMER KATALOGOWY		
040 513	140 cm	1/25



#### GRABIE DO LIŚCI REGULOWANE

Adjustable garden leaf rake • Грабли веерные регулируемые • Laubbesen • Grebla pentru frunze

NUMER KATALOGOWY			
040 506	50 cm	118 cm	1/5



#### NOŻYCE DO TRAWY OBRACANE

Swivel Grass Shear • Ножницы для травы поворотные • Rasenschere drehbar • Foarfeca gazon, rotativa

NUMER KATALOGOWY	
100 573	1/48

**motive**  
Jakość ma znaczenie





**motive**   
Jakość ma znaczenie



**PIŁA UNIWERSALNA SKŁADANA**

Folding Saw • Пила универсальная складная • Klappsäge  
• Fierastrau pentru gradina, pliabil

NUMER  
KATALOGOWY



100 576

1/12



**motive**   
Jakość ma znaczenie



**SEKATOR DO ŻYWOPLÓTU TELESKOPOWY**

Telescopic hedge shears • Ножницы для резки живой изгороди  
• Teleskop Hand Heckenschere • Foarfeca telescopică pentru gard viu

NUMER  
KATALOGOWY



100 577

1/12



**SEKATOR KOWADEŁKOWY**

Anvil Pruning Shear • Секатор с наковаленкой • Gartenschere Amboss  
• Foarfeca de gradina, cu nicovală

NUMER  
KATALOGOWY



100 597

20,5 cm

1/10/60



**SEKATOR KOWADEŁKOWY TELESKOPOWY**

Anvil Lopper • Секатор с наковаленкой двуручный • Teleskop Amboss  
Astschere • Foarfeca de gradina cu maner telescopic, tip nicovală

NUMER  
KATALOGOWY



100 578

62 - 93 cm

1/12



**SEKATOR NOŻYCOWY**

Bypass Pruning Shear • Секатор резчик • Baumschere Schere  
• Foarfeca de gradina

NUMER  
KATALOGOWY



100 579

21,5 cm

1/10/60



### SEKATOR DO GAŁĘZI

Bypass Pruning Shear • Секатор резчик • Baumschere Schere  
• Foarfeca de gradina

NUMER  
KATALOGOWY



100 700

1/10/60

**motive**  
Jakość ma znaczenie



### SEKATOR NOŻYCOWY

Bypass Pruning Shear • Секатор резчик • Baumschere Schere  
• Foarfeca de gradina

NUMER  
KATALOGOWY



100 701

1/10/60

**motive**  
Jakość ma znaczenie



### SEKATOR NOŻYCOWY TELESKOPOWY

Bypass Lopper • Секатор резчик двуручный • Teleskop Astschere  
• Foarfeca de gradina cu maner telescopic

NUMER  
KATALOGOWY



100 580

1/12

**motive**  
Jakość ma znaczenie



### WIDŁY GOSPODARCZE

Manure fork • Четырехзубые вилы • Dunggabel • Furca pentru gunoi

NUMER  
KATALOGOWY



040 540

21 cm

4

1/5

**motive**  
Jakość ma znaczenie



### WIDŁY OGRODOWE HARTOWANE

Garden fork • Трехзубые вилы • Spatengabel • Furca pentru sapat

NUMER  
KATALOGOWY



040 541

21 cm

4

1/5

**motive**  
Jakość ma znaczenie





#### SZUFELKA C.O.

Coal shovel • Соквок металлический • Kohleschaufel • Lopata carbuni

NUMER  
KATALOGOWY



050 198

1



**motive**  
Jakość ma znaczenie



#### SZPADEL HARTOWANY

Tempered spade • Лопата штыковая каленая • Spaten aus gehärteten Stahl mit Metallstiel • Cazma cu maner metal

NUMER  
KATALOGOWY



040 504

20 cm

115 cm

1/5



#### SZPADEL WZMOCNIONY OPRAWNY

Spade, wooden handle • Лопата штыковая укрепленная • Spaten • Cazma cu maner lemn

NUMER  
KATALOGOWY



040 510

20 cm

125 cm

1/5



#### ŁOPATA HARTOWANA

Tempered shovel • Лопата каленая • Schaufel aus gehärteten Stahl mit Metallstiel • Lopata otel

NUMER  
KATALOGOWY



040 503

24 cm

120 cm

1/5



#### ŁOPATA PIASKOWA OPRAWNA

Shovel, wooden handle • Лопата совковая • Sandschaufel • Lopata cu maner lemn

NUMER  
KATALOGOWY



040 500

24 cm

120 cm

1/5



### ŁOPATA WĘGLOWA 2 HARTOWANA

Square shovel • Лопата совковая кованая • Randschaufel  
• Lopata otel, dreptunghiulara

NUMER KATALOGOWY			
040 516	24 cm	120 cm	1/5

### ŁOPATA WĘGLOWA 3 OPRAWNA

Wood handle square shovel • Лопата совковая с деревянным черенком  
• Randschaufel mit Holzstiel • Lopata dreptunghiulara, cu maner lemn

NUMER KATALOGOWY			
040 515	25 cm	120 cm	1/5

### ŁOPATA DO ŚNIEGU WZMACNIANA

Shovel for snow strengthened • Лопата для снега усиленная  
• Schneeschaukel- verstärkt • Lopata pentru zapada

NUMER KATALOGOWY			
040 525		460 x 420 x 1350 mm	1/10/120

### ŁOPATA DO ŚNIEGU

Shovel for snow • Лопата для снега • Schneeschaukel • Lopata pentru zapada

NUMER KATALOGOWY			
040 520		360 x 460 x 1300 mm	1/120

### SPYCHACZ RĘCZNY DO ŚNIEGU

Snow pusher • Лопата „Бульдозер” для снега • Schneewanne mit Rollen  
• Lopata impingator cu roti

NUMER KATALOGOWY			
040 521		790 x 430 x 1400 mm	1/10

**motive**  
Jakość ma znaczenie



**motive**  
Jakość ma znaczenie





#### SKUWACZ DO LODU

Ice chopper • Ледопуб • Eisstösser • Spargator pentru gheata

NUMER  
KATALOGOWY



040 530

200 x 90 x 1050 mm

1/10

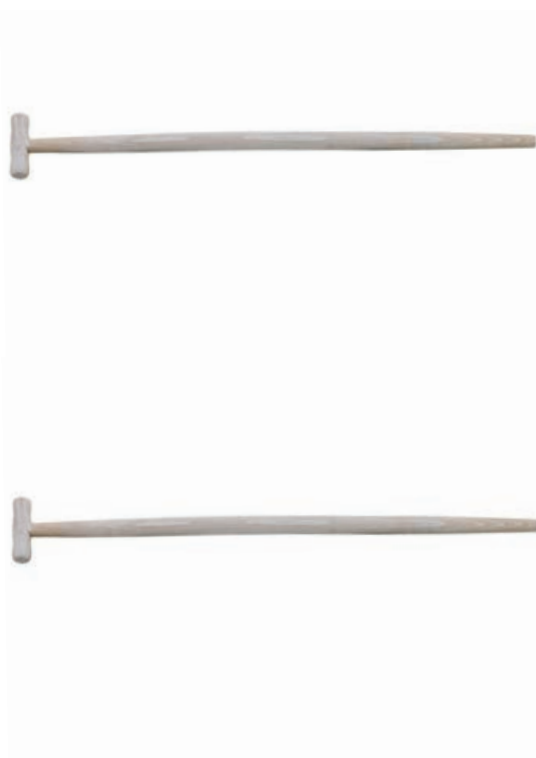

#### TRZON DO SZPADLI

Wooden handle • Черенок для штыковой лопаты • Spatenstiel  
• Coada pentru cazma

NUMER  
KATALOGOWY



040 511

90 cm

1/10

#### TRZON DO ŁOPAT

Wooden handle • Черенок для лопаты • Schaufelstiel • Coada pentru lopata

NUMER  
KATALOGOWY



040 512

100 cm

1/10



#### SZCZOTKA DO KOSIARKI ZE SKROBAKIEM

Lawnmower brush • Чистящая щетка • Rasenmäherbürste mit Schaber  
• Perie pentru maşină de tuns iarba

NUMER  
KATALOGOWY



050 650

1/50



**motive**  
Jakość ma znaczenie



#### SIEKIERA ROZŁUPUJĄCA

Splitting axe • Топор – колун • Spaltaxt • Topor pentru despicat

NUMER  
KATALOGOWY



040 407

1 kg

1/3/12

040 408

2 kg

1/3/6





### SIEKIERA

Tempered axe • Каленый топор • Axt mit Glasfaserstiel • Topor

**motive**  
Jakość ma znaczenie



NUMER KATALOGOWY	kg	1/3/6/24
040 401	0.6 kg	1/3/6/24
040 402	0.8 kg	1/3/24
040 403	1.0 kg	1/3/12
040 404	1.25 kg	1/3/12
040 405	1.6 kg	1/3/6
040 406	2.0 kg	1/3/6

### SIEKIERA HARTOWANA

Tempered axe, wooden handle • Каленый топор • Axt mit gehärtet Kopf  
• Topor, lama otel + coada lemn

NUMER KATALOGOWY	kg	1/3
040 410	0.7 kg	1/3
040 411	0.9 kg	1/3
040 412	1.5 kg	1/3



### TRZON DO SIEKIERY

Shaft to hatchet • Черенок для топора • Axtstiel • Coada pentru topor

NUMER KATALOGOWY	↔	1/25
040 459	50 cm	1/25
040 460	60 cm	1/25
040 461	70 cm	1/25
040 462	80 cm	1/25
040 463	90 cm	1/25



### TRZON DO TOPORKA

Shaft to hatchet • Черенок для топора • Axtstiel • Coada pentru topor

NUMER KATALOGOWY	↔	1/25
040 470	36 cm	1/25



### ZESTAW SKLEPOWY

Shopping connector BOX • Набор фитингов - BOX • Verbindungsstück Satz  
• Conectori- set box

NUMER KATALOGOWY	1
R 1500	1



## PROFESJONALNA PREZENTACJA PRODUKTÓW W TWOIM SKLEPIE LUB SKŁADZIE

### ZAINTERESOWANY?

Skontaktuj się z naszym przedstawicielem w Twoim regionie

### Stwórz własną ekspozycję korzystając z gotowych regałów modułowych

- ✓ w ofercie dostępne są moduły w kilku rozmiarach
- ✓ zatowarowane według naszych sugestii lub wyboru Klienta
- ✓ dostępne w wersji podstawowej lub premium (podświetlane)

SZEROKOŚĆ	GŁĘBOKOŚĆ	WYSOKOŚĆ
60 cm	60 cm	210 cm + logo
120 cm	60 cm	210 cm + logo
133 cm	60 cm	210 cm + logo

REGO1

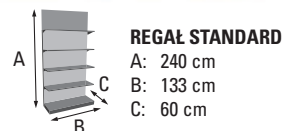

REG1

REG2

REG3

REG4

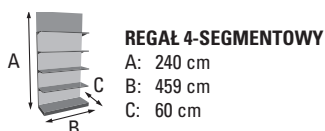



**REGAŁ WYSOKI MASCOT**  
 A: 277 cm  
 B: 119 cm  
 C: 56 cm



**REGAŁ - KOSZ MASCOT**  
 A: 94 cm  
 B: 56 cm  
 C: 56 cm



**REGAŁ - WYSPA MASCOT**  
 A: 152 cm  
 B: 140 cm  
 C: 60 cm



**REGAŁ Z BUTAMI SAFETY JOGGER**  
 A: 253 cm  
 B: 100 cm  
 C: 61 cm



**REGAŁ Z TAŚMAMI**  
 A: 240 cm  
 B: 133 cm  
 C: 60 cm



**REGAŁ GLAZURNICZY**  
 A: 240 cm  
 B: 133 cm  
 C: 60 cm

REG7

REG8

REG9

REG6

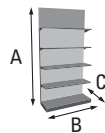

**REGAŁ 4-SEGMENTOWY**

A: 240 cm  
B: 459 cm  
C: 60 cm

REG10

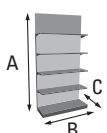

**REGAŁ Z WIERTŁAMI**

A: 240 cm  
B: 133 cm  
C: 60 cm

REG11

REG12

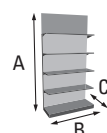

**REGAŁ 2-SEGMENTOWY**

A: 240 cm  
B: 266 cm  
C: 60 cm

REG10

REG13

REG14

REG15

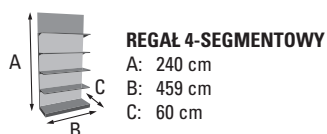

REG11

REG12

REG16

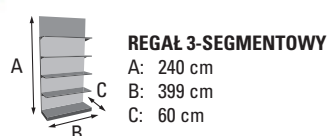

REG38

REG39

REG40

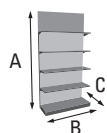

**REGAŁ 3-SEGMENTOWY**

A: 240 cm

B: 300 cm

C: 60 cm

REG49

REG50

REG51

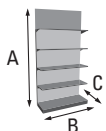

**REGAŁ 3-SEGMENTOWY**

A: 240 cm

B: 300 cm

C: 60 cm

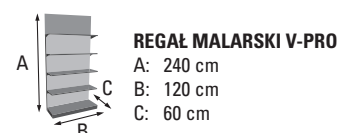
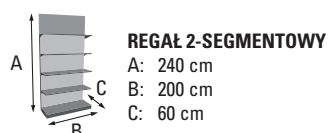
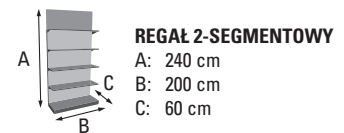
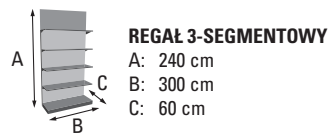
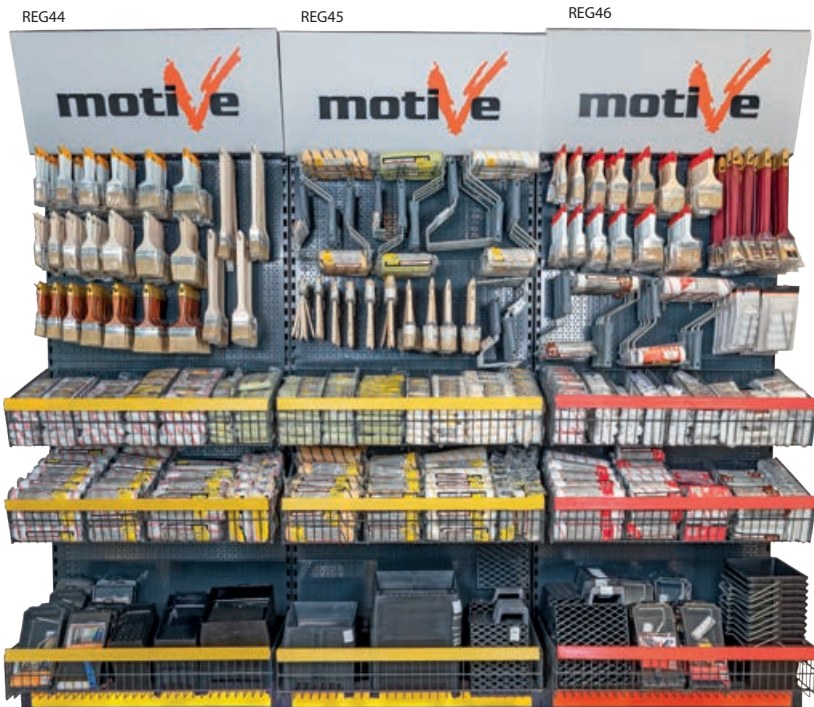

REG17



**REGAŁ STOLARSKI 1-SEGMENTOWY**  
 A: 240 cm  
 B: 133 cm  
 C: 60 cm

REG18



REG19

**REGAŁ STOLARSKI 2-SEGMENTOWY**  
 A: 240 cm  
 B: 266 cm  
 C: 60 cm

REG18



REG20



REG21



**REGAŁ STOLARSKI 3-SEGMENTOWY**  
 A: 240 cm  
 B: 399 cm  
 C: 60 cm





REG37

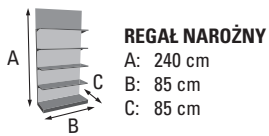

REG52

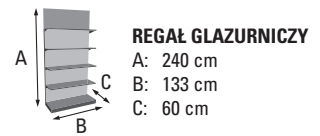

REGB1

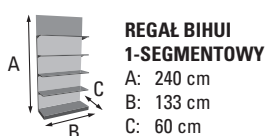

REGB2



REGB3

REGB4

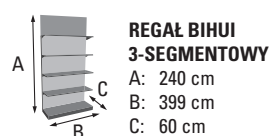

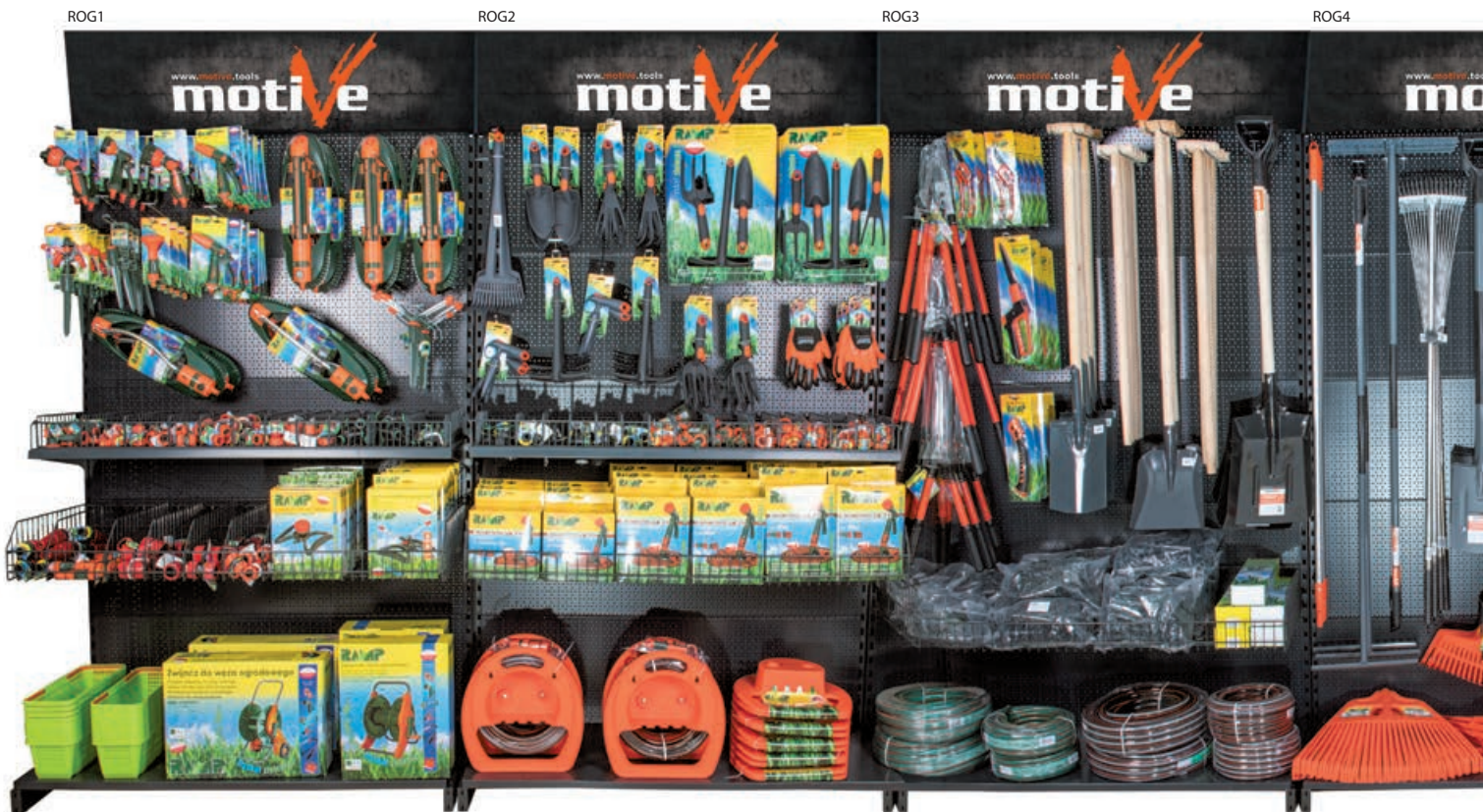

**REGAŁ OGRODOWY 5-SEGMENTOWY**  
 A: 240 cm  
 B: 665 cm  
 C: 60 cm

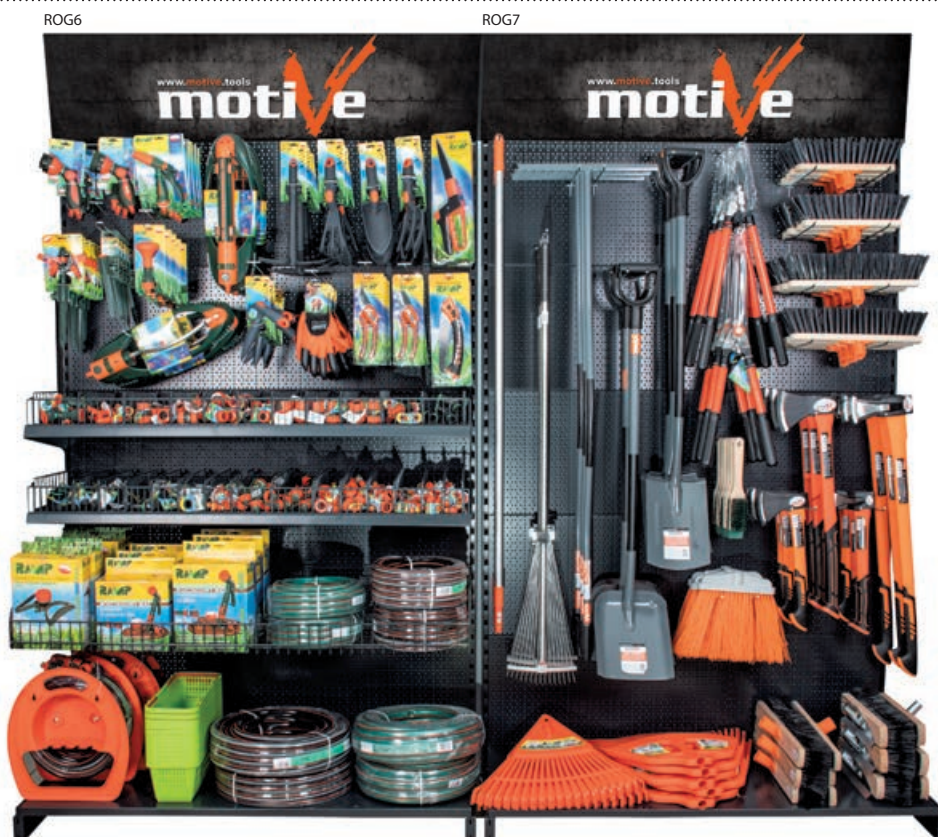

**REGAŁ OGRODOWY 2-SEGMENTOWY**  
 A: 240 cm  
 B: 266 cm  
 C: 60 cm

ROG5



ROG8A

ROG8B

ROG8C

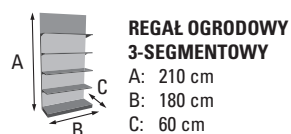

ROG9

ROG10

ROG5

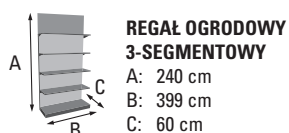

## REGAŁY NA ODKŁADY

Sposób na profesjonalną prezentację produktów oraz efektywne wykorzystanie przestrzeni

- ✓ wykorzystując specjalne ramy zabudowujące nasze regały uzyskujesz dodatkowe miejsce na górze do przechowywania nadmiaru towaru, bez konieczności składowania go na swoim zapleczu
- ✓ z kolei łatwy i szybki dostęp do towaru w odkładzie minimalizuje pojawienie się braków na wieszakach, czy półkach regału
- ✓ estetyczne i reklamowe drzwi zamykające odkład zwracają uwagę klienta oraz oznakowują grupę asortymentu na regale
- ✓ dostosowanie wysokości ramy i odkładu nad regałem pozwala w pełni wykorzystać dostępną przestrzeń w każdym sklepie, czy składzie
- ✓ łączenie ze sobą ram umożliwia tworzenie alejek regałowych

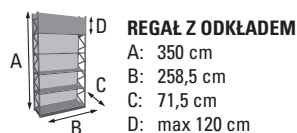



**STOJAK Z WIERTŁAMI**



**EKSPOZYTOR NABLATOWY**

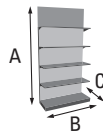

- A: 60 cm
- B: 30 cm
- C: 30 cm

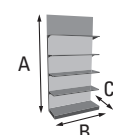

**STOJAK NA POZIOMICE**

- A: 83 cm
- B: 27,5 cm
- C: 41 cm



**STOJAK Z PAPIERAMI ŚCIERNYMI**

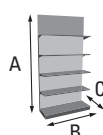

**STOJAK NA PŁÓTNA ŚCIERNE**

- A: 88 cm
- B: 25,5 cm
- C: 80 cm

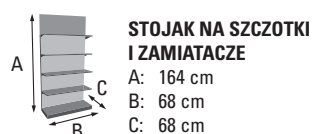
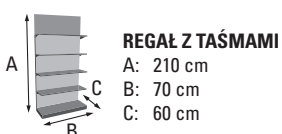
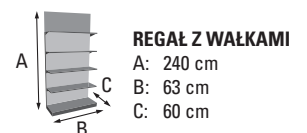



**STOJAK NA TAŚMY**

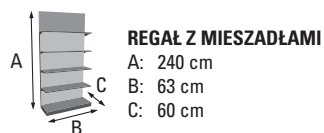
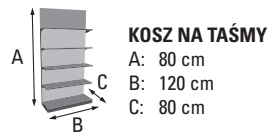

**MANEKIN EKSPOZYCYJNY**

## STANDY TEKTOREWE

Sposób na profesjonalną prezentację produktów oraz efektywne wykorzystanie przestrzeni

- ✓ solidne, tekturowe regały, "po brzegi" wypełnione kompletnym asortymentem
- ✓ intuicyjne w montażu wraz z czytelną instrukcją ułożenia na nich produktów pozwolą na szybkie rozpoczęcie sprzedaży
- ✓ późniejsze braki będą na bieżąco uzupełniane przez naszego handlowca

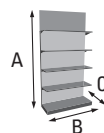

**STAND TEKTOROWY**

A: 173 cm

B: 60 cm

C: 42 cm

STAND Z WORKAMI		
Worki na śmieci 35 L (25 szt.)	010 221	6 szt.
Worki na śmieci 60 L (25 szt.)	010 222	5 szt.
Worki na śmieci 120 L (25 szt.)	010 223	8 szt.
Worki na śmieci 160 L (10 szt.)	010 224	5 szt.
Worki na śmieci 240 L (10 szt.)	010 240	10 szt.
Worki przemysłowe, czarne 70 L (10 szt.)	010 150	10 szt.
Worki przemysłowe, czarne 120 L (10 szt.)	010 151	10 szt.
Worki przemysłowe, czarne 160 L (10 szt.)	010 152	4 szt.
Worki przemysłowe, czarne 240 L (10 szt.)	010 153	4 szt.
Worki przemysłowe, czarne 320 L (10 szt.)	010 154	4 szt.
Worki przemysłowe, niebieskie 120 L (10 szt.)	010 160	6 szt.
Worki przemysłowe, niebieskie 240 L (10 szt.)	010 161	8 szt.
Worki na gruz 70 L (10 szt.)	010 258	4 szt.
Worki na gruz 120 L (10 szt.)	010 242	8 szt.
Worki brązowe (BIO) (25 szt.)	010 253	5 szt.
Worki zielone (SZKŁO) (25 szt.)	010 254	5 szt.
Worki żółte (PLASTIK) (25 szt.)	010 255	6 szt.
Worki niebieskie (PAPIER) (25 szt.)	010 256	6 szt.
Worki do odpadów lekkich 1200 x 2400 (5 szt.)	010 245	10 szt.

STAND GLAZURNICZY		
Nakolanniki	010 367	4 szt.
Kliny do poziomowania płytek (100 szt.)	070 077	6 szt.
Klipsy 1 mm do poziomowania płytek (100 szt.)	070 078	20 szt.
Klipsy 2 mm do poziomowania płytek (100 szt.)	070 079	10 szt.
Klipsy 2 mm wysokie (100 szt.)	070 085	10 szt.
Klipsy 3 mm do poziomowania płytek (100 szt.)	070 087	10 szt.
Szczypce do systemu poziomowania płytek	070 086	6 szt.
Zestaw do poziomowania płytek	070 088	2 szt.
System poziomowania wielokrotnego użytku (50 szt.)	070 089	5 szt.
Wykrojnik	070 121	10 szt.
Szablon do kształtów	070 123	10 szt.
Paca do fugowania z gumą ściętą	070 138	7 szt.







# PRZEJDŹ NA WYŻSZY POZIOM KORZYŚCI ZAMAWIAJ ONLINE!

ZAŁÓŻ I AKTYWUJ KONTO U HANDLOWCA Z TWOJEGO REGIONU,  
ZAMAWIAJ W PROSTY SPOSÓB, BEZPOŚREDNIO ZE STRONY:

**[www.interb2b.abstore.pl](http://www.interb2b.abstore.pl)**

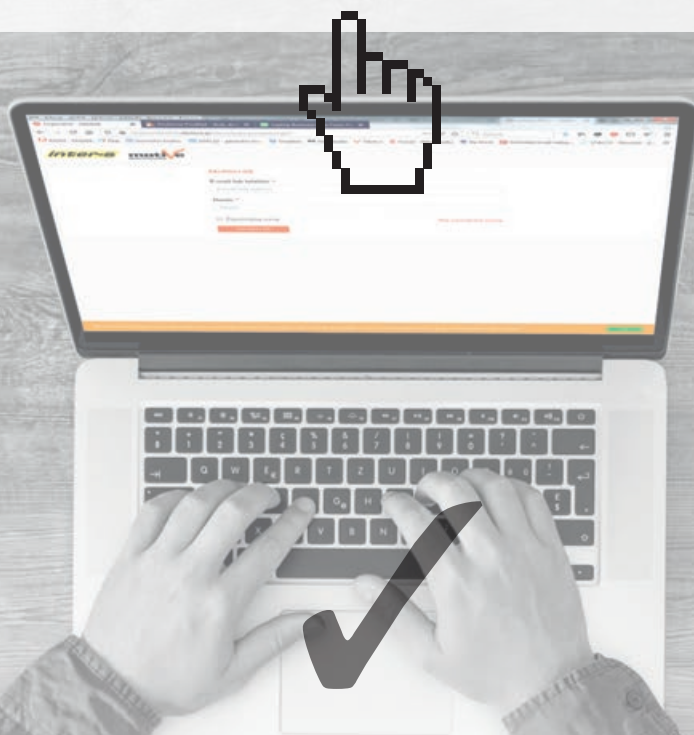

**Intuicyjne przeglądanie  
asortymentu, w tym  
również nowości  
produktowych**

**Łatwe konfigurowanie  
nowych zamówień oraz  
powielanie poprzednich,  
bez konieczności ponownego  
wpisywania pozycji**

**Wygodny dostęp  
do historii swoich zamówień  
i rozrachunków**

**OPTYMALIZUJ SWÓJ CENNY CZAS, ZAMAWIAJ KIEDY I GDZIE CHCESZ**

**O SZCZEGÓŁY ZAPYTAJ HANDLOWCĄ W TWOIM REGIONIE**

**motive**  
*Jakość ma znaczenie*

Inter-s Sp. z o.o.  
ul. Mazowiecka 10, 96-300 Żyrardów  
tel.: +48 46 854 42 47, fax: 46 855 00 76  
e-mail: [biuro@inter-s.pl](mailto:biuro@inter-s.pl)  
[www.inter-s.pl](http://www.inter-s.pl), [www.motive.tools](http://www.motive.tools)

