

Wózek transportowy















Należy przeczytać przed użyciem

- ✓ Nadaje się do umieszczania płytek o rozmiarze do 3,2 x 1,6 m
- ✓ Maksymalne obciążenie 280 kg (617 lbs)
- ✓ Cztery tarcze obrotowe wyposażone są w hamulce



KOMPONENTY

- | | | |
|----|---|-----|
| 1 |  | x1 |
| 2 |  | x2 |
| 3 |  | x2 |
| 4 |  | x1 |
| 5 |  | x2 |
| 6 |  | x2 |
| 7 |  | x12 |
| 8 |  | x12 |
| 9 |  | x8 |
| 10 |  | x12 |
| 11 |  | x8 |
| 12 |  | x1 |
| 13 |  | x1 |

INSTRUKCJE MONTAŻU - 1

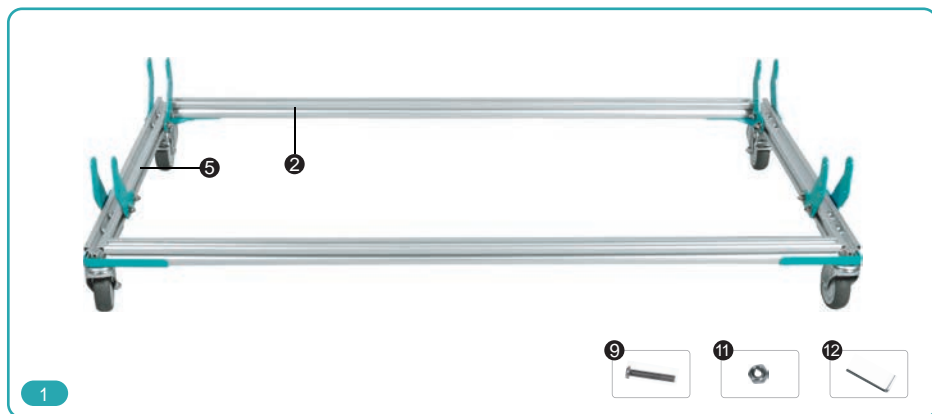

INSTRUKCJE MONTAŻU - 2

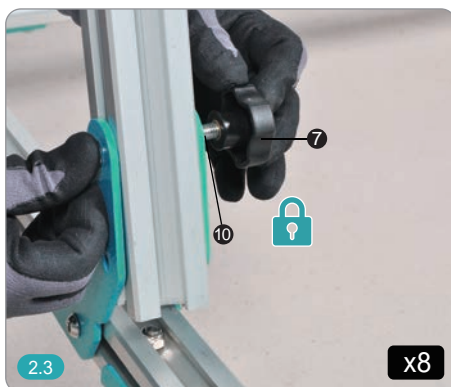
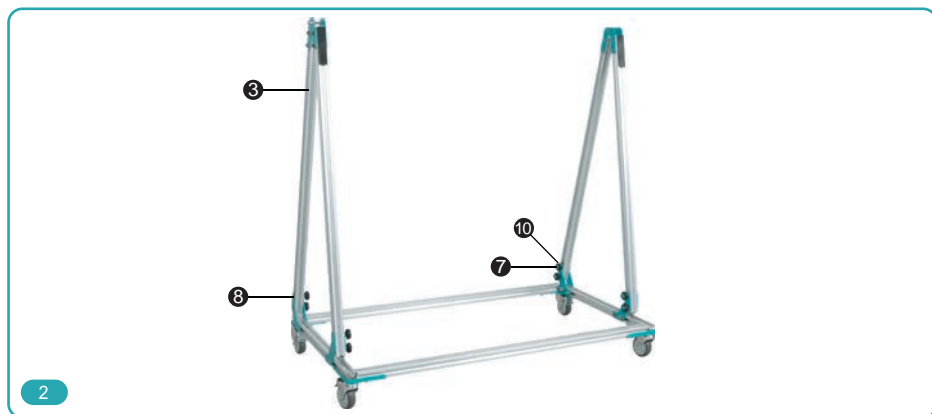

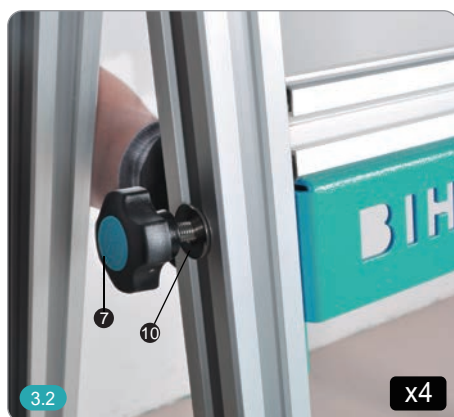
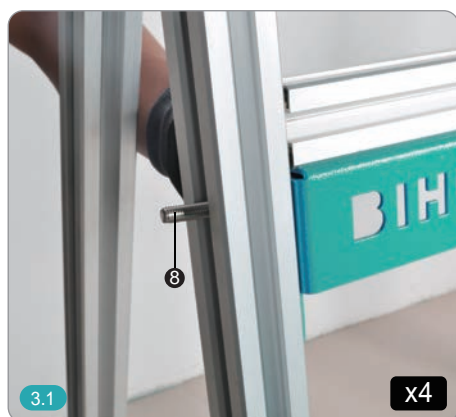
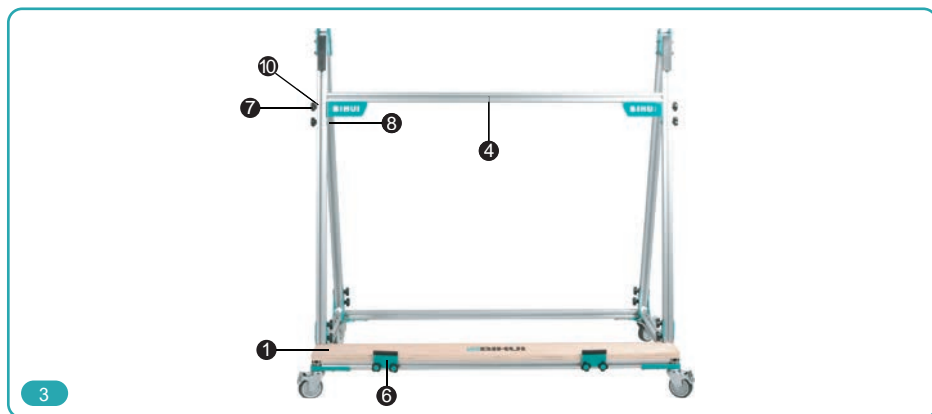
INSTRUKCJE MONTAŻU - 3

INSTRUKCJE MONTAŻU - 3

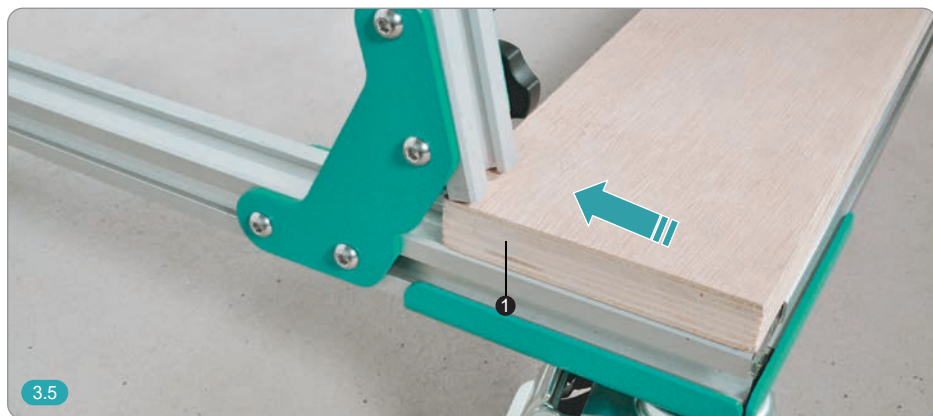

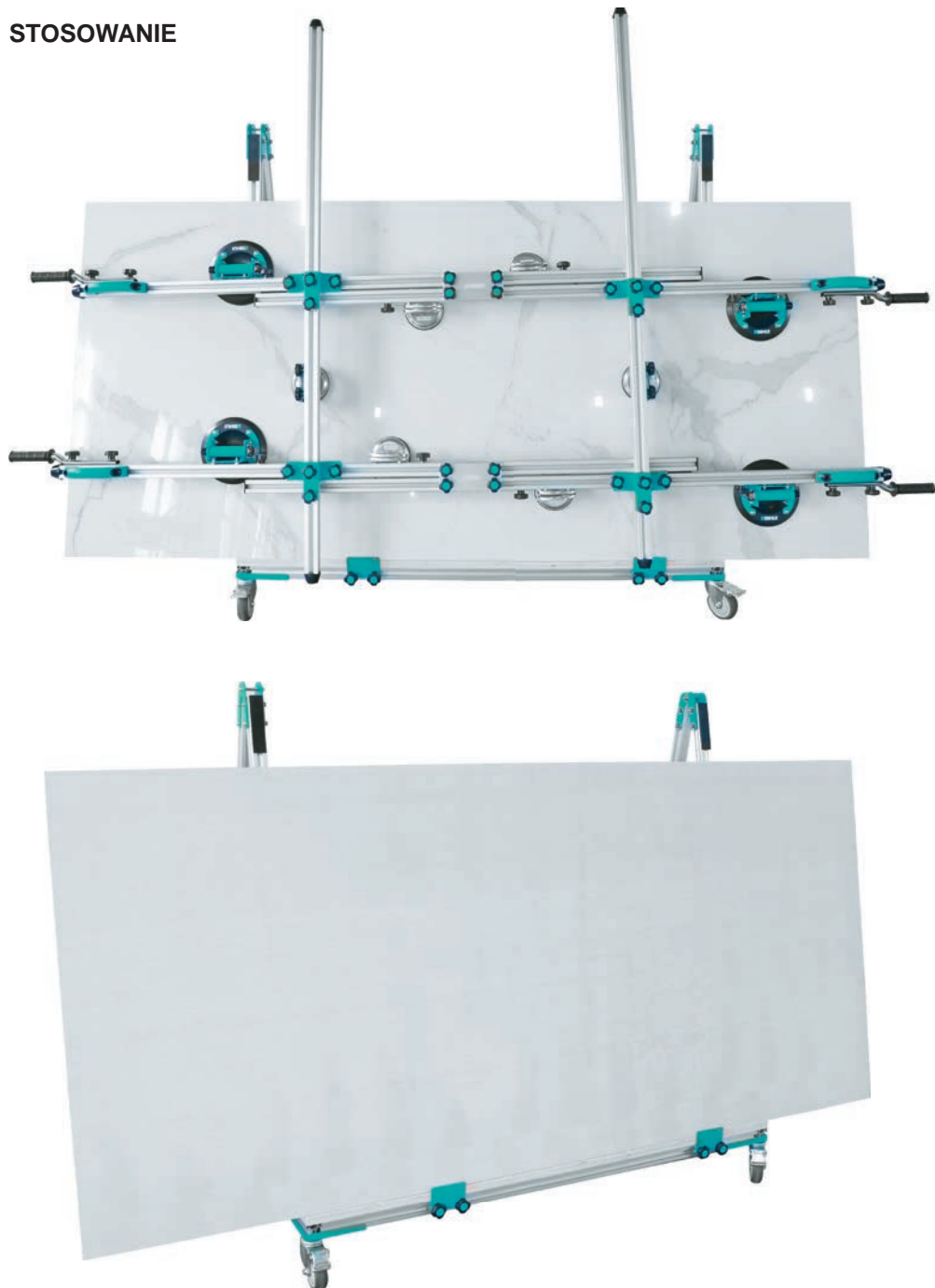
STOSOWANIE



www.bihuitools.pl